



Portable MiniDisc Recorder

Operating Instructions

Recorder Operation _____ **page 12**

Software Operation _____ **page 38**

NetMD



MDLP

AM-NX9

WARNING

To prevent fire or shock hazard, do not expose the unit to rain or moisture.

Do not install the appliance in a confined space, such as a bookcase or built-in cabinet.

To prevent fire, do not cover the ventilation of the apparatus with news papers, table cloths, curtains, etc. And don't place lighted candles on the apparatus.

To prevent fire or shock hazard, do not place objects filled with liquids, such as vases, on the apparatus.

Certain countries may regulate disposal of the battery used to power this product. Please consult with your local authority.

Caution

The use of optical instruments with this product will increase eye hazard.

CAUTION — INVISIBLE LASER RADIATION WHEN OPEN

AVOID EXPOSURE TO BEAM

Information

IN NO EVENT SHALL SELLER BE LIABLE FOR ANY DIRECT, INCIDENTAL OR CONSEQUENTIAL DAMAGES OF ANY NATURE, OR LOSSES OR EXPENSES RESULTING FROM ANY DEFECTIVE PRODUCT OR THE USE OF ANY PRODUCT.

The validity of the CE marking is restricted to only those countries where it is legally enforced, mainly in the countries EEA (European Economic Area).

For customers who purchased this product in the USA

Owner's Record

The serial number is located at the rear of the disc compartment lid and the model number is located at the top and bottom. Record the serial number in the space provided below. Refer to them whenever you call upon your Aiwa dealer regarding this product.

Model No. AM-NX9

Serial No. _____

Declaration of Conformity

Trade Name: AIWA

Model No.: AM-NX9

Responsible Party: Sony Electronics Inc.

Address: 680 Kinderkamack Road, Oradell, NJ 07649 USA

Telephone No.: 201-930-6973

This device complies with Part 15 of the FCC Rules. Operation is subject to the following two conditions: (1) This device may not cause harmful interference, and (2) this device must accept any interference received, including interference that may cause undesired operation.

This equipment has been tested and found to comply with the limits for a Class B digital device, pursuant to Part 15 of the FCC Rules. These limits are designed to provide reasonable protection against harmful interference in a residential installation. This equipment generates, uses, and can radiate radio frequency energy and, if not installed and used in accordance with the instructions, may cause harmful interference to radio communications. However, there is no guarantee that interference will not occur in a particular installation. If this equipment does cause harmful interference to radio or television reception, which can be determined by turning the equipment off and on, the user is encouraged to try to correct the interference by one or more of the following measures:

- Reorient or relocate the receiving antenna.
- Increase the separation between the equipment and receiver.
- Connect the equipment into an outlet on a circuit different from that to which the receiver is connected.
- Consult the dealer or an experienced radio/TV technician for help.

You are cautioned that any changes or modifications not expressly approved in this manual could void your authority to operate this equipment.

- SonicStage, OpenMG and the OpenMG logo, MagicGate Memory Stick and the MagicGate Memory Stick logo, Memory Stick and the Memory Stick logo, Net MD and the Net MD logo, ATRAC, ATRAC3 and ATRAC3 plus are trademarks of Sony Corporation.
- Microsoft, Windows, Windows NT and Windows Media are trademarks or registered trademarks of Microsoft Corporation in the United States and /or other countries.
- IBM and PC/AT are registered trademarks of International Business Machines Corporation.
- Macintosh is a trademark of Apple Computer, Inc. in the United States and/or other countries.
- Pentium is a registered trademark of Intel Corporation.
- All other trademarks and registered trademarks are trademarks or registered trademarks of their respective holders.
- TM and ® marks are omitted in this manual.

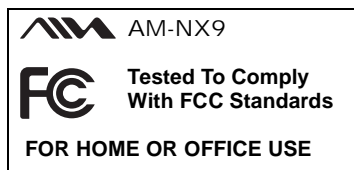

Notice for users

On the supplied software

- Copyright laws prohibit reproducing the software or the manual accompanying it in whole or in part, or renting the software without the permission of the copyright holder.
- In no event will SONY be liable for any financial damage, or loss of profits, including claims made by third parties, arising out of the use of the software supplied with this recorder.
- In the event a problem occurs with this software as a result of defective manufacturing, SONY will replace it. However, SONY bears no other responsibility.
- The software provided with this recorder cannot be used with equipment other than that which is so designated.
- Please note that, due to continued efforts to improve quality, the software specifications may be changed without notice.
- Operation of this recorder with software other than that provided is not covered by the warranty.

Program © 2001, 2002, 2003 Sony Corporation

Documentation © 2003 Sony Corporation

Table of contents

Recorder Operations

Looking at the controls	13
-------------------------------	----

Getting started!	15
------------------------	----

Using your computer to record from an audio CD!	16
---	----

Playing an MD right away!	19
---------------------------------	----

Various ways of playback	21
Selecting the play mode	21
Adjusting treble or bass (Digital Sound Preset)	22
Selecting the sound quality	22
Adjusting the sound quality	22

Using the group function	24
What is the group function?	24
Playing a track in group play	24
Selecting the play mode for group play (Group Play Mode)	25

Other Operations	26
Viewing various information	26
Turning off the beep sound	27
Starting the playback quickly (Quick Mode)	27
Protecting your hearing (EAR G.)	28
Locking the controls (HOLD)	28

Power sources	29
When to replace the battery	29
Battery life	29
Using house current	29

Additional information	30
Precautions	30
Specifications	32

Troubleshooting and explanations	33
Troubles and solutions	33
While playing	33
While recording	34
While using group function	34
Others	35
Explanations	36

Software Operation

What is a Net MD?	39
-------------------------	----

Basic Operations	40
Basic operational flow using the Net MD	40
Providing the required system environment	41
System requirements	41
Installing the software onto your computer	42
Before installing the software	42
Installing SonicStage Ver.1.5	43
Connecting the Net MD to your computer	45
Storing audio data to your computer	46
Starting SonicStage	46
Recording audio CDs to the hard disk drive	47
Labeling audio data	49
Transferring audio data from your computer to the Net MD (Check-out)	50
Checking out audio files to the Net MD	50
Listening to an MD	53
Listening to an MD with the Net MD connected to the computer	53
Listening to an MD with the Net MD disconnected from the computer	53

Advanced operations	54
Using other functions!	54
Using the SonicStage online help	54

Other information	56
Settings and Precautions	56
Settings according to OS	56
For users with OpenMG Jukebox, SonicStage, SonicStage Premium, or SonicStage Simple Burner installed on their computer	58
Note on hard disk drive space	59
Notes on system suspend/hibernation mode	59
Backing up the audio data	59
Uninstalling the SonicStage software	60
For Windows XP users	60
For Windows Millennium Edition/Windows 98 Second Edition users	60
For Windows 2000 users	61
Troubleshooting	62
If your computer does not recognize the Net MD	64
If the installation was not successful	64
Information and explanations	66
Net MD FAQ	66
On copyright protection	67
Glossary	69
Index	71

Before using this product

This recorder can only record materials from the connected computer. This manual explains the recorder operations and the installation and basic use of the supplied SonicStage software. For details on the various operations, refer to the pages indicated below.

When using the recorder

Recorder Operation (pages 12 to 36)

Pages 12 to 36 in this manual explain the use of the Net MD as an ordinary MiniDisc recorder.

Troubleshooting and explanations (page 33)

This section shows the troubles you may find while using the recorder, and their solutions.



When using the Net MD (the recorder) connected to your computer

For SonicStage Ver. 1.5 software

Software Operation (pages 38 to 70)

Pages 38 to 70 in this manual explain the installation and basic operations of the supplied SonicStage software. Refer to these pages for details.

Other information (page 56)

This section shows the troubles you may find while using the SonicStage software, and their solutions. It also has the list of frequently asked questions and answers.

SonicStage Ver. 1.5 Help

This is an online help that you can view on your computer screen.

Refer to online help for details on the use of the software.

To display the help window, see page 54.

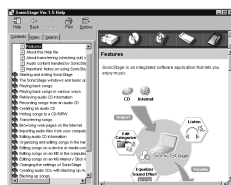

For Net MD Simple Burner Ver. 1.2 software

Net MD Simple Burner Ver. 1.2 Operating Instructions

This manual explains the installation and operations of the supplied Net MD Simple Burner software.



Notes on the “Software Operation” section

- The displayed items in the illustrations that appear in this section may differ from the actual items displayed by the software.
- Explanations in this section assume familiarity with basic Windows operations. For details on the use of your computer and the operating system, please refer to the respective manuals.
- Explanations in this section cover general Net MD products. For this reason, some explanations (and some illustrations) may not be applicable to your Net MD. Please refer to the operating instructions of your Net MD as well.

Checking the supplied accessories

AC power adaptor (1)

Headphones/earphones (1)

Dedicated USB cable (1)

CD-ROM (SonicStage Ver. 1.5 and Net MD Simple Burner Ver. 1.2) (1)*

*Do not play a CD-ROM on an audio CD player.

Looking at the controls

Front of the recorder

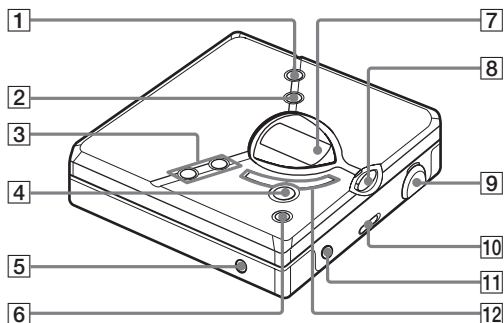

1 GROUP button

2 MENU button

3 VOL +* and – buttons

* The VOL + button has a tactile dot.

4 ►||/ENTER (play/pause/enter) button*

* The ►||/ENTER button has a tactile dot.

5 DC IN 3V jack

6 ■STOP/CANCEL (stop/cancel) button

7 Display window

8 DOWNLOAD button

9 USB jack

When connecting to your computer, connect the dedicated USB cable to this jack.

10 HOLD switch

11 Ⓞ (headphones/earphones) jack

12 ◀◀ and ▶▶ (skip/search) buttons

Back of the recorder

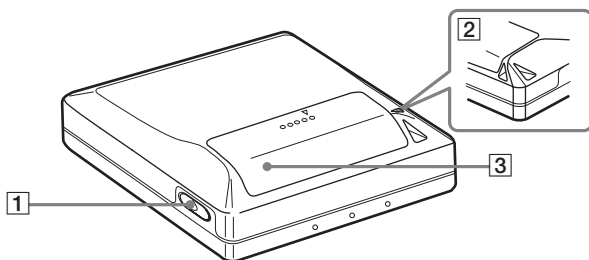

- 1** OPEN button
- 2** Hand strap hole
Use the hole to attach your own strap.
- 3** Battery compartment lid

The display window of the recorder

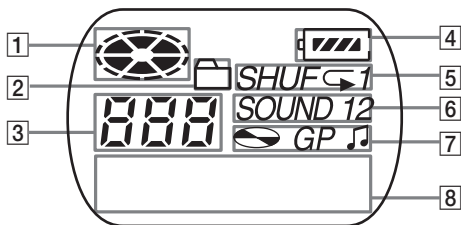

- 1** Disc indication
- 2** Group mode indication
Lights up when group mode is on.
- 3** Track number display
- 4** Battery level indication
Shows approximate battery condition.
- 5** Play mode indication
Shows play mode of the MD.
- 6** SOUND indication
- 7** Disc, group, track indication
- 8** Character information display
Displays the track names, elapsed time, etc.

Getting started!

1 Insert an alkaline dry battery.

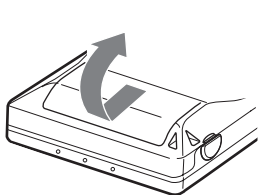

Slide to open the battery compartment lid.

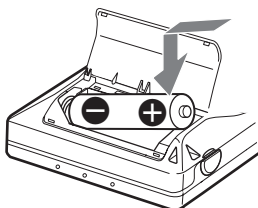

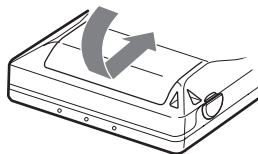

Insert one LR6 (size AA) alkaline dry battery minus end first.



Close the lid.

2 Make connections and unlock the control.

1 Connect the headphones/earphones to .

2 Slide HOLD in the opposite direction of the arrow indicated on the recorder (HOLD ) to unlock the control.

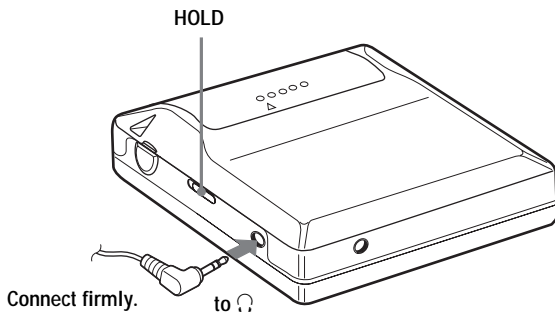

Using your computer to record from an audio CD!

You can record tracks from an audio CD inserted in the CD-ROM drive of your computer to an MD by connecting the recorder to the computer with the dedicated USB cable. For this procedure, you must first install the supplied “Net MD Simple Burner” software.

The following procedure explains the use of the recorder’s DOWNLOAD button to perform recording. For details on installing the software and other recording operations, see the supplied “Net MD Simple Burner Ver. 1.2 Operating Instructions”.

1 Install the Net MD Simple Burner software.

If you are installing the software for the first time, use the supplied CD-ROM. Refer to the supplied “Net MD Simple Burner Ver. 1.2 Operating Instructions” for details.

2 Insert a recordable MD into the recorder.

- 1 Press OPEN to open the recorder.

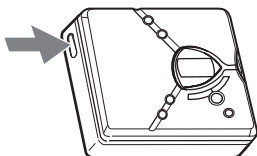

- 2 Insert a recordable MD to the direction of the arrow with the label side facing front.

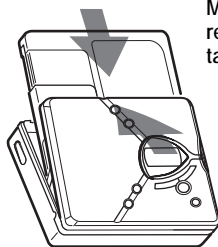

Make sure the record-protect tab is closed.

- 3 Press the lid down to close.

3 Make the necessary connections.

Connect the AC power adaptor to the recorder and the dedicated USB cable from the recorder to the computer.

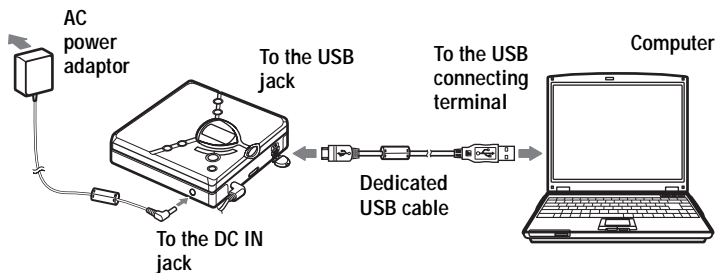

4 Insert an audio CD into the CD-ROM drive of your computer.

5 Make sure all connections are correct.

If all connections are correct, the DOWNLOAD button lights up.

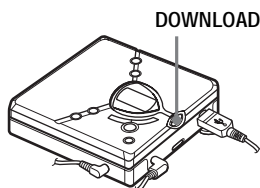

6 Press DOWNLOAD for 2 seconds or more.

The DOWNLOAD button starts flashing and recording starts. New material will be recorded after the end of the existing contents.

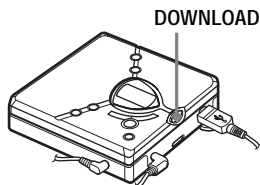

To stop recording

Click [Abort] in the display of your computer.
You can also stop recording by pressing the ■STOP/CANCEL button on the recorder only when the first track is being recorded.

To remove the MD

Press ■ and wait until "Edit" disappears from the display.

Notes

- Do not disconnect the dedicated USB cable or the AC power adaptor while the DOWNLOAD button is flashing. If you do, a mis-operation may occur.
- Place the recorder on a stable surface so that the dedicated USB cable does not become detached.

Playing an MD right away!

1 Insert an MD.

1 Press OPEN to open the lid.

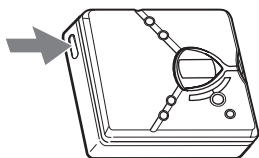

2 Insert an MD to the direction of the arrow with the label side facing front, and press the lid down to close.

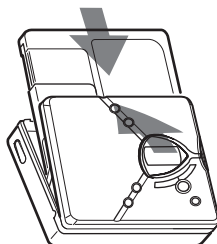

3 Insert a new LR6 (size AA) alkaline dry battery.

2 Play an MD.

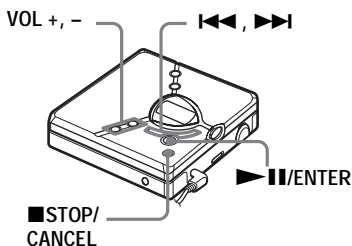

1 Press ▶||.

2 Press VOL + or - to adjust the volume.
The volume indicator appears in the display allowing you to check the volume level.

To stop play, press ■.

Playback starts from the point you last stopped playing.

To start playback from the beginning of the first track, hold down ▶|| for 2 seconds or more.

To	Operation
Pause	Press ▶ . Press ▶ again to resume play.
Find the beginning of the current track or the previous track ¹⁾	Press ◀◀ . Press ◀◀ repeatedly until the beginning of the desired track appears.
Find the beginning of the next track ²⁾	Press ▶▶ once.
Go backwards or forward while playing	Hold down ◀◀ or ▶▶ .
Search for a point in a track while viewing the elapsed time (Time search)	While pausing, press and hold ◀◀ or ▶▶ .
Search for a specific track while viewing track numbers (Index search)	While the recorder is stopped, press and hold ◀◀ or ▶▶ .
Remove the MD	Press ■ , and then press OPEN. ³⁾

¹⁾ If you press **◀◀** twice continuously while playing the first track of the disc, the recorder goes to the beginning of the last track on the disc.

²⁾ If you press **▶▶** during the last track of the disc, the recorder goes to the beginning of the first track on the disc.

³⁾ If you open the lid, the playback will begin from the beginning of the first track (except when group mode is on).

Suppressing the skip of the sound (E • A • S • S GP)

The E • A • S • S GP function was developed to provide a higher level of shock resistance than that of existing players in order to allow the recorder to be used while jogging.

Note

The playback sound may skip if:

- the recorder receives stronger continuous shock.
- a dirty or scratched MiniDisc is played.



- The AM-NX9 supports DSP TYPE-S for ATRAC/ATRAC3. It thus allows you to enjoy TYPE-S high-quality sound from MDs recorded in MDLP mode on TYPE-S-equipped MD decks, etc.
- The recorder can play the track recorded by 2 × or 4 × long playing mode (LP2 or LP4). Normal stereo playback, LP2 stereo playback, LP4 stereo playback or monaural playback is automatically selected to match the audio source.

Selecting the play mode

You can select various play modes such as normal play, single-track play (1 Trk), or shuffle play (Shuff). You can also select repeat play with the selected play mode.

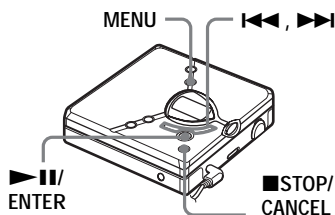

- 1 Press MENU.
- 2 Press ◀◀ or ▶▶ repeatedly until “P-MODE” appears in the display, and then press ▶||/ENTER.
- 3 Press ◀◀ or ▶▶ repeatedly to select the play mode, and then press ▶||/ENTER.

Each time you press ▶▶, the display item indicated by **A** changes as follows:
 Pressing ▶||/ENTER while **A** is flashing causes the play mode to enter.

Pressing ▶▶ repeatedly changes **A**.

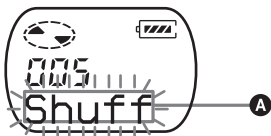

Display A ¹⁾	Play mode
Normal (normal play)	All the tracks are played once.
1 Trk (single-track play)	A single track is played once.

Display A ¹⁾	Play mode
Shuff (shuffle play)	All the tracks are played in random order.

¹⁾ Group play mode (📁) appears whenever you play a disc with group settings. For more details, see “Playing a track in group play” (page 24).

- 4 Press ◀◀ or ▶▶ repeatedly until “RepOFF” or “RepON” (playing a track repeatedly) appears in the display, and then press ▶||/ENTER to enter the selection.

If you select “RepON”, “↺” appears on **B** and the playback repeats with the play mode selected in step 3.

B lights up when you press ▶||/ENTER.

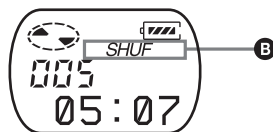

Display B	Play mode
↺	Repeat play of all tracks
↺ 1	Repeat play of a selected track
SHUF ↺	Repeat shuffle play of all tracks

To cancel the procedure
 Press MENU.

To return the preceding settings
 Press ■STOP/CANCEL.

Adjusting treble or bass (Digital Sound Preset)

You can adjust the treble and bass to suit your taste. The player can store two sets of treble-bass adjustments, which can then be selected later during playback.

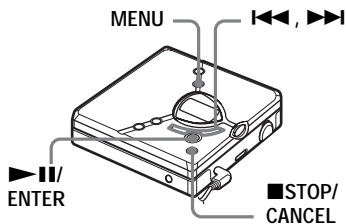

Selecting the sound quality

Factory settings

Factory settings of the digital sound preset are as follows:

- “SOUND1”: bass +1, treble ± 0
- “SOUND2”: bass +3, treble ± 0

- 1 While playing, press MENU.
- 2 Press **◀◀** or **▶▶** repeatedly until “SOUND” appears in the display, and press **▶||/ENTER**.
- 3 Press **◀◀** or **▶▶** repeatedly to select “SOUND1”, “SOUND2”, or “OFF” in the display, and then press **▶||/ENTER** to enter the selection.

Selecting “OFF” turns off the digital sound preset function.

Adjusting the sound quality

You can change the preset sound quality. To change the preset sound quality, select “SOUND1” or “SOUND2”, the one you want to change, in advance.

- 1 While playing, press MENU.
- 2 Press **◀◀** or **▶▶** repeatedly until “SOUND” appears in the display, and then press **▶||/ENTER**.
- 3 Press **◀◀** or **▶▶** repeatedly until “SET” appears in the display, and then press **▶||/ENTER**.
- 4 Press **◀◀** or **▶▶** repeatedly until “SOUND1” or “SOUND2” appears in the display, and then press **▶||/ENTER**.

The display shows the currently “BASS” sound setting.

- 5 Press **◀◀** or **▶▶** repeatedly to adjust the sound level.

Shows “SOUND1” or “SOUND2” is selected



The sound can be adjusted in 8 steps. (-4, -3, ..., ± 0 , ..., +2, +3)

- 6 Press **▶||/ENTER**.
“BASS” is set and the display changes to “TRE” (treble) setting mode.
- 7 Press **◀◀** or **▶▶** repeatedly to adjust the sound level, and then press **▶||/ENTER** to enter the selection.
“TRE” (treble) is set.
The sound settings are saved and the playback display appears again.

To cancel the procedure

Press MENU.

To return the preceding settings

Press ■STOP/CANCEL.

Note

When using a digital sound preset, the sound may break or become distorted if the volume is turned up too high, depending on the settings or the track. In this case, change the settings of the sound quality.

What is the group function?

The group function is provided to allow playback of discs with group settings. The group function is convenient for playback of MDs on which several albums or CD singles have been recorded in MDLP (LP2/LP4) mode.

What is a disc with group settings?

The recorder can operate various functions in units of group; that is tracks that have been recorded on a disc as part of separate groups, as shown below.

Before group settings are made

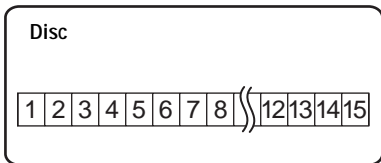

- Track 1 to 5 are assigned to group 1.
- Track 8 to 12 are assigned to group 2.
- Track 13 to 15 are assigned to group 3.
- Track 6 to 7 are assigned to no group.

After setting the group (group play)

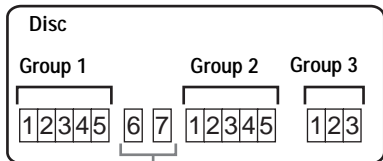

Tracks that were not assigned to a group are treated as being part of "GP --".

You can create a maximum of 99 groups on a disc.

Note

The recorder does not support the recording of group settings on the recorder. Use the supplied SonicStage software to assign tracks to group. For details, see "Software Operation" section (page 38).

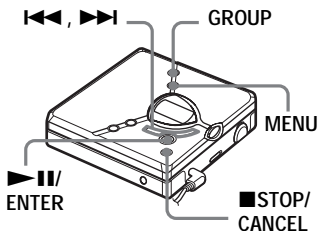

Playing a track in group play

In group play, all groups are played in order, starting with group 1, followed by the unassigned tracks ("GP --"). Playback stops after all the tracks have been played.

- 1 Press MENU.
- 2 Press **⏮** or **⏭** repeatedly until "P-MODE" appears in the display, and then press **▶||/ENTER**.
- 3 Press **⏮** or **⏭** repeatedly until "☞" and "Normal" appear in the display, and then press **▶||/ENTER**.
- 4 Press **⏮** or **⏭** repeatedly until "RepOFF" appears in the display, and then press **▶||/ENTER** to enter the selection.

To cue to the start of a group (Group Skip)



- 1 While playing, press GROUP.
- 2 Press **⏮** or **⏭**. Pressing the **⏮** or **⏭** button cues to the first track of the previous or next group.

Selecting the play mode for group play (Group Play Mode)



The shuffle play and repeat play function can be used during group play mode.

- 1 Press MENU.
- 2 Press **◀◀** or **▶▶** until “P-MODE” appears in the display, and then press **▶||/ENTER**.
- 3 Press **◀◀** or **▶▶** repeatedly to select the play mode, and then press **▶||/ENTER**.

After normal playback (page 21), the following play modes are displayed.

Display	Play mode
 , Normal (Normal Group Play)	All tracks in the groups play back once (starting with the first track in group 1).
 , Shuff (In-Group Shuffle)	Shuffle play starts with the group that is currently playing, and continues with the succeeding groups.

- 4 Press **◀◀** or **▶▶** repeatedly until “RepOFF” or “RepON” appears in the display, and then press **▶||/ENTER** to enter the selection.
If you select “RepON”, “↶” appears in the display and playback repeats in the respective group play mode (Group Repeat Play).

Display	Play mode
 , ↶	Repeat play of tracks within a group
 , SHUF ↶	Repeat shuffle play of tracks within a group

To cancel the procedure
Press MENU.

To return the preceding settings

Press **■STOP/CANCEL**.

Viewing various information

You can check the track name, disc name, etc. during playback. Group-related items appear only when a track with group settings is played.

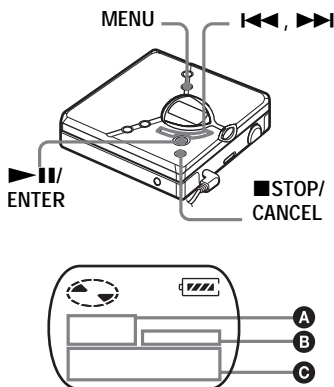

A	B	C
Track number	—	The elapsed time
Track number	🎵	Track name
The number of total tracks in the groups	GP	Group name
The number of total tracks	🎵	Disc name
Track number	—	Track mode

- 1 Press MENU.
- 2 Press ◀◀ or ▶▶ repeatedly until "DISP" appears in the display, and then press ▶||/ENTER.

- 3 Press ◀◀ or ▶▶ repeatedly until the information that you want appears in the display, and then press ▶||/ENTER to enter the selection.

Each time you press ▶||/ENTER, the display changes as follows:

Display	Meaning
LapTim	The elapsed time of the current track
T:Name	Track name
G:Name	Group name
D:Name	Disc name
T-MODE	Indicates the recording mode selected on the MD recorder used; i.e., "SP", "LP2", "LP4", or "MONO".

Notes

- Depending on the group settings, the operating conditions and the disc settings, you may not be able to select certain indications or the indications may appear differently.
- The "T-MODE" indication appears only during playback. It appears for a few seconds, and is then replaced by the elapsed time of the current track.

To cancel the procedure
Press MENU.

To return the preceding settings
Press ■STOP/CANCEL.

Turning off the beep sound

You can turn off the beep sound in the headphones/earphones.

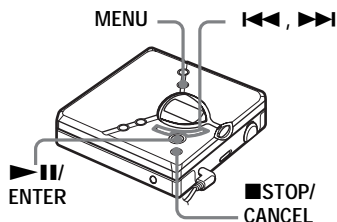

- 1 Press MENU.
- 2 Press **◀◀** or **▶▶** repeatedly until “OPTION” appears in the display, and then press **▶||/ENTER**.
- 3 Press **◀◀** or **▶▶** repeatedly until “BEEP” appears in the display, and then press **▶||/ENTER**.
- 4 Press **◀◀** or **▶▶** repeatedly until “OFF” appears in the display, and then press **▶||/ENTER**.

To turn on the beep sound
Select “ON” in step 4.

To cancel the procedure
Press MENU.

To return the preceding
settings
Press **■STOP/CANCEL**.

Starting the playback quickly (Quick Mode)

After pressing the playback button or cueing to the track, the playback can start quickly.

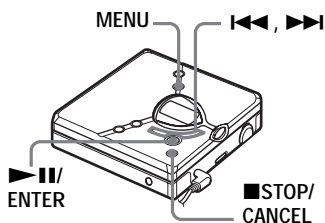

- 1 Press MENU.
- 2 Press **◀◀** or **▶▶** repeatedly until “OPTION” appears in the display, and then press **▶||/ENTER**.
- 3 Press **◀◀** or **▶▶** repeatedly until “Power” appears in the display, and then press **▶||/ENTER**.
- 4 Press **◀◀** or **▶▶** repeatedly until “QUICK” appears in the display, and then press **▶||/ENTER**.

To switch back to the normal
setting

Select “NORMAL” in step 4.

To cancel the procedure
Press MENU.

To return the preceding
settings
Press **■STOP/CANCEL**.

Notes

- When the power mode is set to “QUICK”, the power remains on within the recorder even when nothing appears in the display. This leads to a shorter battery life.
- If no recorder operation (including opening or closing of the lid) occurs for an hour, the power in the recorder automatically turn off. For this reason, the next time you start playback or do another operation, the recorder will not respond quickly. The unit, however, will return to quick mode afterwards.

Protecting your hearing (EAR G.)

The EAR G. (Ear Guard) function keeps down the maximum volume to protect your ears.

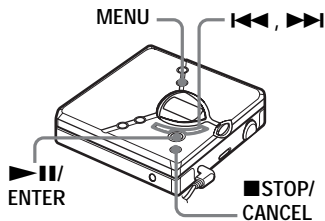

- 1 Press MENU.
- 2 Press **◀◀** or **▶▶** repeatedly until “OPTION” appears in the display, and then press **▶||/ENTER**.
- 3 Press **◀◀** or **▶▶** repeatedly until “EAR G.” appears in the display, and then press **▶||/ENTER**.
- 4 Press **◀◀** or **▶▶** repeatedly until “ON” appears in the display, and then press **▶||/ENTER** to enter the selection.

“ON” appears in the display, and after a few seconds, the playback display appears again.

To cancel the EAR G. function
Select “OFF” in step 4.

To cancel the procedure
Press MENU.

To return the preceding settings
Press **■STOP/CANCEL**.

Locking the controls (HOLD)

To prevent the buttons from being accidentally operated when you carry the player, use this function.

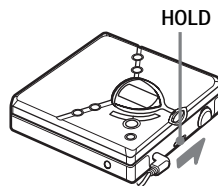

- 1 Slide HOLD in the direction of the **→** to lock.

To unlock the controls
Slide HOLD to the opposite direction of the arrow.

You can power the recorder not only with alkaline dry battery but also with house current. You cannot, however, use manganese dry battery.

When to replace the battery

You can check the battery condition with the battery indicator which is displayed while using the recorder. The battery indicator changes due to the battery condition.

The battery level indicator is approximate.

Battery indicator

 Battery power decreasing

↓
 Weak battery

↓
 The battery has gone out. "LoBATT" flashes in the display on the recorder, and the power goes off.

Battery life¹⁾

The battery life may be shorter due to operating conditions and the temperature of the location.

Unit: approx.hours (JEITA²⁾)

When	SP stereo	LP2 stereo	LP4 stereo
playing	42	48	56

¹⁾ When using a new Sony LR6 (size AA) "STAMINA" alkaline dry battery (produced in Japan).

²⁾ Measured in accordance with the JEITA (Japan Electronics and Information Technology Industries Association) standard.

Note

The battery life may be shorter than that specified, depending on the operating conditions, the temperature of the location, and varieties of a battery.

Using house current

- 1 Connect the AC power adaptor to DC IN 3V.
- 2 Connect the AC power adaptor to the wall outlet.

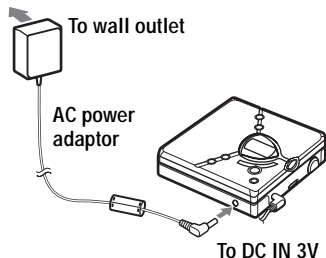

Notes

- For use in your house: Use the AC power adaptor. Do not use an AC power adaptor other than the recommended one since it may cause the recorder to malfunction.

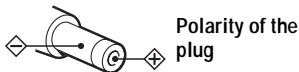

- There are regional differences in the supplied AC power adaptor specifications. For this reason, you should verify that the power requirements and plug configuration are appropriate for your area before you purchase the recorder.
- Connect the AC power adaptor to an easily accessible AC outlet. Should you notice an abnormality in the AC power adaptor, disconnect it from the AC outlet immediately.

Precautions

On safety

- Do not put any foreign objects in the DC IN 3V jack.
- Do not carry or store the dry battery in the same place with metallic objects such as coins, key rings, or necklaces. This may cause a short-circuit and the generation of heat.
- Incorrect battery usage may cause the battery fluid to leak or battery to burst. To prevent such accidents, make sure the battery is installed with the + and - poles oriented correctly.
- If a battery leak should develop, carefully and thoroughly wipe away the battery fluid in the battery compartment before inserting a new battery.
- If you will not use the recorder for a long time, be sure to remove the dry battery.

On power sources

- Use LR6 (size AA) batteries, house current, or car battery.
- The recorder is not disconnected from the AC power source (mains) as long as it is connected to the wall outlet, even if the recorder itself has been turned off.
- If you are not going to use this recorder for a long time, be sure to disconnect the power supply (the AC power adaptor, dry battery, or car battery cord). To remove the AC power adaptor from the wall outlet, grasp the adaptor plug itself; never pull the cord.

On Handling

- Do not drop or bump the recorder. This may cause the recorder to malfunction.
- Do not pull headphones/earphones cords.
- Do not place the recorder in the following places:
 - An extremely hot place
 - A place exposed to direct sunlight or near a heater
 - In a car with the windows rolled up (especially in the summer)
 - In a damp place such as a bathroom
 - Near a source of electromagnetic fields such as a magnet, speaker, or TV
 - In a dusty place

On heat build-up

Heat may build up in the recorder if it is used for an extended period of time. This, however, is not a malfunction.

On mechanical noise

The recorder emits mechanical noise while operating, which is caused by the power-saving system of the recorder. This is not a malfunction.

On installation

- Never use the recorder where it will be subjected to extremes of light, temperature, moisture or vibration.
- Never wrap the recorder in anything when it is being used with the AC power adaptor. Heat build-up in the recorder may cause malfunction or damage.

On the MiniDisc cartridge

- Do not touch the internal disc directly. Forcing the shutter open may damage the internal disc.
- When transporting a MiniDisc, keep it in its case.
- Do not place the cartridge where it will be subjected to light, temperature, moisture or dust.
- Do not affix the label outside of the specified area on the MD. Make sure the label is placed within the recessed space on the disc.

On the headphones/earphones

Road safety

Do not use headphones/earphones while driving, cycling, or operating any motorized vehicle. This may lead to a traffic accident and is illegal in many areas. It can also be potentially dangerous to play your recorder at high volumes while walking, especially at pedestrian crossings. You should exercise extreme caution or discontinue using the recorder in potentially hazardous situations.

Preventing hearing damage

Avoid using headphones/earphones at high volumes. Hearing experts advise against continuous, loud and extended play. If you experience a ringing in your ears, reduce the volume or discontinue use.

Caring for others

Keep the volume at a moderate level. This will allow you to hear outside sounds and to be considerate of the people around you.

On cleaning

- After wiping the recorder casing with a soft cloth slightly moistened with water, wipe it again with a dry cloth. Do not use any type of abrasive pad, scouring powder or solvent such as alcohol or benzene as this may mar the finish on the casing.
- Wipe the disc cartridge with a dry cloth to remove dirt.
- Dust on the lens may prevent the unit from operating properly. Be sure to close the disc compartment lid after inserting or ejecting an MD.
- To maintain good sound quality, use a soft cloth to clean the plugs of the headphones/earphones. A dirty plug may cause noise or intermittent breaks in the sound during playback.
- Clean the terminals periodically with a cotton swab or a soft cloth as illustrated.

Dry battery compartment

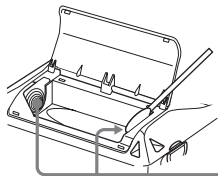

Terminals

To protect a recorded MD

To record-protect an MD, slide open the tab at the side of the MD. In this position, the MD cannot be recorded. To record again, slide the tab back so the tab is visible.

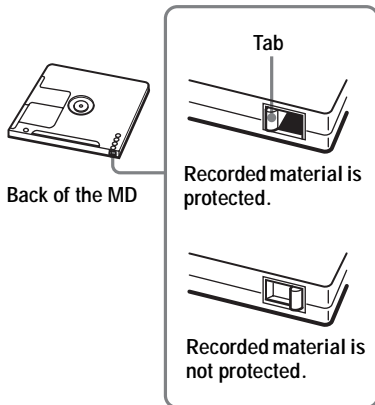

If you have any questions or problems concerning your recorder, please consult your nearest Aiwa dealer. (If a trouble occurred when the disc was in the recorder, we recommend that the disc be left in the recorder when you consult your Aiwa dealer so that the cause of trouble may be better understood.) When consulting your Aiwa dealer, be sure to bring the recorder and the headphones/earphones.

Specifications

MD recorder

Audio playing system

MiniDisc digital audio system

Laser diode properties

Material: GaAlAs

Wavelength: $\lambda = 790 \text{ nm}$

Emission duration: continuous

Laser output: less than 44.6 μW

(This output is the value measured at a distance of 200 mm from the objective lens surface on the optical pick-up block with 7 mm aperture.)

Recording and playback time (when using MDW-80)

Maximum 160 min. in monaural

Maximum 320 min. in LP4 stereo

Revolutions

Approx. 380 rpm to 2,700 rpm

Error correction

ACIRC (Advanced Cross Interleave Reed Solomon Code)

Sampling frequency

44.1 kHz

Coding

ATRAC (Adaptive TRansform Acoustic Coding)

ATRAC3 — LP2/LP4

Modulation system

EFM (Eight to Fourteen Modulation)

Number of channels

2 stereo channels

1 monaural channel

Frequency response

20 to 20,000 Hz $\pm 3 \text{ dB}$

Outputs

⦿ stereo mini-jack, maximum output level

2 mW + 2 mW, load impedance 16 Ω

(European models)

5 mW + 5 mW, load impedance 16 Ω (other models)

General

Power requirements

AC Power Adaptor connected at the DC IN 3V jack:

120 V AC, 60 Hz (Models for USA, Canada, Mexico, and Taiwan)

230 V AC, 50/60 Hz (Models for continental Europe and Chili)

240 V AC, 50 Hz (Model for Australia)

220 V AC, 50 Hz (Model for China)

230 V AC, 50 Hz (Models for U.K. and Hong Kong)

220 V AC, 60 Hz (Model for Korea)

100 - 120 V/220 - 240 V AC, 50/60 Hz (Other models)

The recorder:

One LR6 (size AA) alkaline battery (not supplied)

Recommended temperature for check-in/check-out

+5 °C (+41 °F) or higher

Battery operation time

See "Battery life" (page 29)

Dimensions

Approx. 81.6 \times 29.9 \times 75.0 mm (w/h/d) (3¹/₄ \times 1³/₁₆ \times 3 in.) without projections.

Mass

Approx. 104 g (3.7 oz) the recorder only

US and foreign patents licensed from Dolby Laboratories.

Design and specifications are subject to change without notice.

Your dealer may not handle some of the above listed accessories. Please ask the dealer for detailed information about the accessories in your country.



Troubles and solutions

If you find any troubles operating the recorder, follow the steps below.

- 1 Check this section, “Troubles and solutions” (page 33).
- 2 If you cannot solve the problem after you made checks, consult your nearest Aiwa dealer.

While playing

Symptom	Cause/Remedy
An MD is not played normally.	<ul style="list-style-type: none">• Repeat play is selected. ➔ Use MENU on the recorder to change back to the normal play (page 21).• Playback mode is changed. ➔ Use MENU on the recorder to change back to the normal play (page 21).
An MD is not played from the first track.	<ul style="list-style-type: none">• Disc playing stopped before it came to the last track. ➔ Press ► for 2 seconds or more to start playing.• Group play mode is selected. ➔ Use MENU on the recorder to change back to the normal play (page 21), and then press ► for 2 seconds or more to start playing.
The digital sound preset function does not work.	<ul style="list-style-type: none">• The digital sound preset is off. ➔ Select “SOUND1” or “SOUND2” (page 22).
Playback sound skips.	<ul style="list-style-type: none">• The recorder is placed where it receives continuous vibration. ➔ Put the recorder on a stable place.• A very short track may cause sound to skip. ➔ Try not to create a track under one second long.
Sound has a lot of static.	<ul style="list-style-type: none">• Strong magnetism from a television or such device is interfering with operation. ➔ Move the recorder away from the source of strong magnetism.
Noise is momentarily heard.	<ul style="list-style-type: none">• The sound was recorded in LP4 stereo mode. ➔ Because of the nature of the compression method used in LP4 mode, noise may be output on very rare occasions during playback of sound recorded in this mode.
Volume cannot be turned up.	<ul style="list-style-type: none">• EAR G. is on. ➔ Release EAR G. settings (page 28).

Symptom	Cause/Remedy
No sound comes through the headphones/earphones.	<ul style="list-style-type: none"> • The headphones/earphones plug is not firmly connected. ➔ Plug in the plug of the headphones/earphones firmly to . • Volume is too low. ➔ Adjust the volume by pressing VOL + or -. • The plug is dirty. ➔ Clean the plug.
The recorder skips to several tracks ahead or behind when you press ⏮ or ⏭ .	<ul style="list-style-type: none"> • The GROUP button has been pressed ( is flashing in the display). ➔ The recorder returns to normal if no operation has made for 5 seconds.
The edited tracks may exhibit sound dropout during search operations.	<ul style="list-style-type: none"> • This occurs due to the MiniDisc system limitation. The fragmentation of data may cause sound dropout while searching because the tracks are played in higher speed than normal playback.

While recording

Symptom	Cause/Solution
Recording does not occur when you press the DOWNLOAD button	<ul style="list-style-type: none"> • The recorder is not connected to the computer. ➔ Connect the recorder to the computer with the dedicated USB cable. • An audio CD is not inserted in the CD-ROM drive of the computer. ➔ Insert an audio CD into the CD-ROM drive of the computer. • There isn't enough recordable space on the inserted MD. ➔ Insert another recordable MD. • The disk in your computer's CD-ROM drive is not an audio CD. ➔ Insert an audio CD. • The record-protect tab is opened (page 31). ➔ Close the record-protect tab.

While using group function

Symptom	Cause/Remedy
The group function does not operate.	<ul style="list-style-type: none"> • While using a disc with no group setting, an attempt was made to select some group-related menu ("No Gp" appears in the display). ➔ Use a disc with group setting.

Symptom	Cause/Remedy
A track cannot be checked out to a new group. A new group cannot be created on the supplied SonicStage software.	<ul style="list-style-type: none"> This is due to the MiniDisc system limitations. Group information has been written to the area where the disc name is stored. The disc name and track names are recorded in the same area, which can store a maximum of approximately 1,700 characters. If the total number exceeds this amount, a new group cannot be created even though group mode is on. It is also impossible to make group settings at this time.

Others

Symptom	Cause/Remedy
The recorder does not work or works poorly.	<ul style="list-style-type: none"> The volume is low. <ul style="list-style-type: none"> ➔ Turn up the volume. No disc is inserted (“NoDISC” appears in the display). <ul style="list-style-type: none"> ➔ Insert a recorded disc. The HOLD function is turned on (“HOLD” appears in the display when you press an operation button on the recorder). <ul style="list-style-type: none"> ➔ Disable HOLD by sliding the HOLD switch to the opposite direction of the arrow. The lid is not firmly closed. <ul style="list-style-type: none"> ➔ Close the lid until it clicks. Moisture has condensed inside the recorder. <ul style="list-style-type: none"> ➔ Take the MD out and leave the recorder in a warm place for several hours until the moisture evaporates. The dry battery is weak (“LoBATT” flashes or nothing appears). <ul style="list-style-type: none"> ➔ Replace the dry battery with a new one. The dry battery has been inserted incorrectly. <ul style="list-style-type: none"> ➔ Insert the battery correctly. An MD with nothing recorded on is inserted (“BLANK” appears in the display). <ul style="list-style-type: none"> ➔ Insert a recorded MD. The disc is damaged or does not contain proper recording (“Rd ERR” appears in the display). <ul style="list-style-type: none"> ➔ Reinsert the disc. If the error message still appears, replace it with another disc. While operating, the recorder received a mechanical shock, too much static, abnormal power voltage caused by lightning, etc. <ul style="list-style-type: none"> ➔ Restart the operation as follows. <ol style="list-style-type: none"> 1 Disconnect all the power sources. 2 Leave the recorder for about 30 seconds. 3 Connect the power source.

Explanations

About the DSP TYPE-S for ATRAC/ATRAC3

This recorder supports playback with the DSP TYPE-S specification for high-level MiniDisc decks equipped with digital signal processors (DSP). This specification allows tracks recorded in MDLP mode to be played back with high quality sound. Since this recorder also supports DSP TYPE-R specification, superb sound is produced during playback in SP (normal stereo) mode as well.

Suppressing the skips of the sound (E•A•S•S GP)

The E•A•S•S GP function was developed to provide a higher level of shock resistance than that of existing players.

Recording audio data to your computer

You can record audio data to your computer from sources such as audio CDs and the Internet (page 46).



Audio CDs



Internet



On the computer

Listening

You can listen to an audio CD in the CD-ROM drive of your computer, or audio data in the hard disk drive (page 53).



What is a Net MD?

Net MD is a standard that enables the transfer of audio data from a computer to a MiniDisc device. To use this Net MD with your computer requires a software application called "SonicStage".

SonicStage software provides a database for managing audio data in the computer and functions for playing the audio data in various play modes, editing the data, and transferring the results to other devices and hardware connected to the computer. It is an integrated software application with a variety of functions for enjoying music.

Transferring audio data to the Net MD

You can transfer audio data stored in your computer to an MD (page 50).

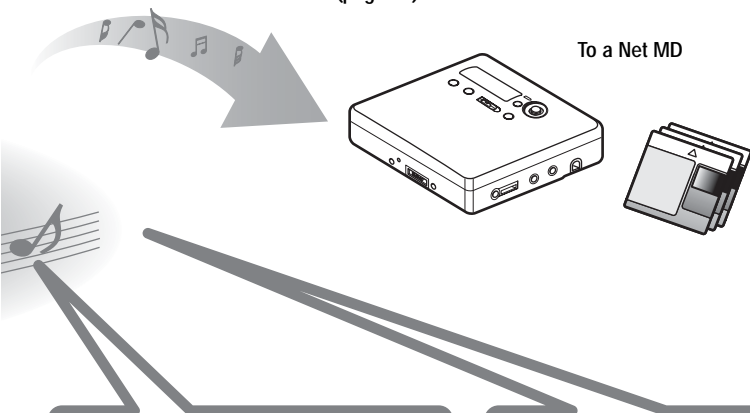

Editing

You can easily edit audio data or add labels from the keyboard (page 49).



Creating a music library

You can create a music library of your favorite songs on your computer.



Basic operational flow using the Net MD

The following is the basic steps that you will take following the purchase of your recorder. Through these steps, you will prepare and set up your computer for use of your recorder as a Net MD. Do the following steps, and refer to the indicated pages for details.

1 Providing the required system environment.

(page 41)

2 Installing the software onto your computer.

(page 42)

3 Connecting the Net MD to your computer.

(page 45)

4 Storing audio data to your computer.

In this manual, recording from an audio CD is explained.

(page 46)

5 Transferring audio data from your computer to an MD (Check-out).

(page 50)

6 Listening to an MD.

You can listen to audio data that have been checked out from your computer to your Net MD.

(page 53)

Providing the required system environment

System requirements

The following hardware and software are required in order to use the SonicStage software for the Net MD.

Computer	IBM PC/AT or Compatible
	<ul style="list-style-type: none">• CPU: Pentium II 400 MHz or higher (Pentium III 450 MHz or higher is recommended.)• Hard disk drive space¹⁾: 120 MB or more• RAM: 64 MB or more (128 MB or more is recommended)
	Others
	<ul style="list-style-type: none">• CD-ROM drive (capable of digital playback by WDM)• Sound Board• USB port (supports USB (conventionally called USB 1.1))
Operating System	Factory installed: Windows XP Home Edition/Windows XP Professional/Windows Millennium Edition/Windows 2000 Professional/Windows 98 Second Edition
Display	High Color (16bit) or higher, 800 × 480 dots or better (800 × 600 dots or better is recommended)
Others	<ul style="list-style-type: none">• Internet access: for EMD services and CD information services• Windows Media Player (version 7.0 or higher) installed for playing WMA files

¹⁾ See page 59 for details.

This software is not supported by the following environments:

- Macintosh
- Windows XP versions other than Home Edition or Professional
- Windows 2000 versions other than Professional
- Windows 98 versions other than Second Edition
- Windows NT
- Windows 95
- Personally constructed PCs or operating systems
- An environment that is an upgrade of the original manufacturer-installed operating system
- Multi-boot environment
- Multi-monitor environment

Notes

- We do not ensure trouble-free operation on all computers that satisfy the system requirements.
- We do not ensure trouble-free operation of the system suspend, sleep, or hibernation function on all computers.

Installing the software onto your computer

This section explains the installation of the SonicStage Ver.1.5 software supplied with your Net MD.

Before installing the software

1 Make sure to note the following before installing the software.



Do not connect the dedicated USB cable before the installation!

The SonicStage software may not correctly load or operate if the dedicated USB cable is connected to your computer during the installation.



Close all other Windows applications before starting the installation!

Make sure to close any virus-check software, as such software usually demand large amounts of system resources.

2 Depending on the following operating system or software already installed on your computer, refer to the reference pages before installing the software.

Windows XP → page 56	<ul style="list-style-type: none">• To install this software, you must log on with a user name with “Computer Administrator”.• If you perform the “System Restore” function in the Windows “System Tools” menu, the tracks managed by SonicStage may become corrupted and rendered unplayable.
Windows Millennium Edition → page 57	<ul style="list-style-type: none">• If you perform the “System Restore” function of the Windows “System Tools” menu, the tracks managed by SonicStage may become corrupted and rendered unplayable.
Windows 2000 → page 57	<ul style="list-style-type: none">• You must log on as “Administrator” before installing the software.
OpenMG Jukebox, SonicStage, SonicStage Premium, or SonicStage Simple Burner → page 58	<ul style="list-style-type: none">• Depending on the version of your software, the existing software may be overwritten by the new version or it may co-exist with SonicStage Ver.1.5. As the installation process will depend on the version, see the reference page for details.

Installing SonicStage Ver.1.5

1 Turn on your computer and start up Windows.

2 Insert the installation CD-ROM for SonicStage into the CD-ROM drive of your computer.

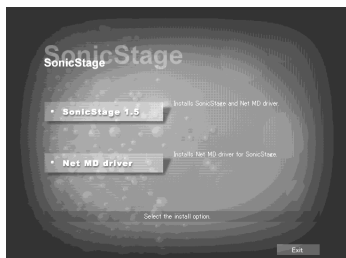

The setup program starts up automatically and the SonicStage Ver.1.5 installation window appears.

3 Click to select [SonicStage 1.5].

To use this software with the Net MD, you must install SonicStage Ver.1.5 and the Net MD driver.

Click [SonicStage 1.5]

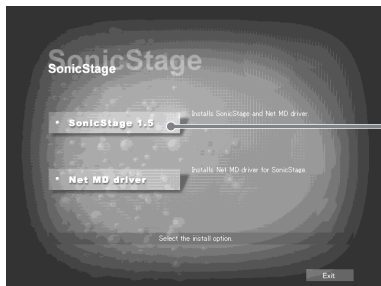

- When installing SonicStage for the first time
 - When OpenMG Jukebox, SonicStage, SonicStage Premium, or SonicStage Simple Burner is installed on the computer
-

continued

4 Follow the displayed instructions.

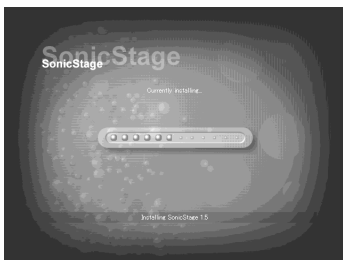

Read the instructions carefully. The installation may take 20 to 30 minutes, depending on your system environment (page 65).

5 After the installation is completed, click [Restart] to restart the computer.

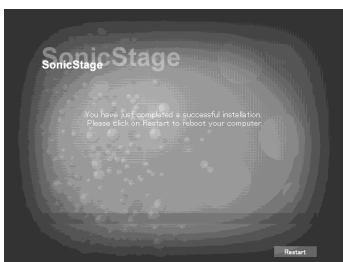

Make sure to restart your computer only after the installation has completed.

Was the installation successful?

If any trouble occurs during the installation, see “Troubleshooting” (page 62).

Notes

- Do not delete, move, or edit any of the installed folders using Explorer or any other application. Doing so could cause the SonicStage database to become unstable or corrupted.
- While the installation is still in progress, do not interrupt the operation or take the CD-ROM out of the CD-ROM drive. Doing so may render it impossible to install the software thereafter.

Connecting the Net MD to your computer

After the software installation is completed, connect the Net MD to your computer. Refer to the operating instructions of the Net MD as well.

- 1 Insert a recordable disc into the Net MD.
 - 2 Make the power source and the dedicated USB cable connections with the Net MD and the computer.
-

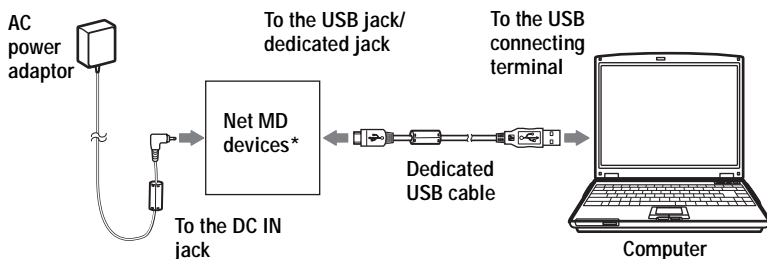

* If a cradle is supplied with your Net MD, connect the dedicated USB cable to the USB cradle and place the Net MD onto the USB cradle.

- 3 Check the connections.

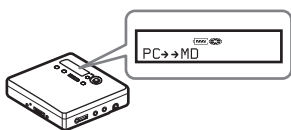

When the connections have been properly made, "PC->MD"* appears in the display of the Net MD.

*Depending on the device, "Net MD" may be displayed.

Notes

- When using the Net MD connected to your computer, make sure to run the recorder from an AC outlet. We do not assure the results should there be a mis-operation, check-out failure, or destruction of audio data caused by insufficient battery power.
- Place the recorder on a stable surface so that the dedicated USB cable does not become detached.

Storing audio data to your computer

This section explains how to record and store audio data from an audio CD to the hard disk drive of your computer.

The procedure in this section is used to record all tracks on an audio CD. To record only specific tracks from a CD, or from other sound sources, see the online help for details (page 54).

Note

The system may malfunction if your computer changes to system suspend or hibernation mode while the software is playing, recording, or connecting to an external device or media* such as a Net MD. Make sure to disable any changes to suspend or hibernation mode. See page 59 for details.

* For this software, the word “MD” refers to the built-in MD slot on the computer, and “Device/Media” to a Net MD that is externally connected over a USB cable.

Starting SonicStage

Do one of the following:

- Double click  ([SonicStage] icon) on the computer.
- Select [Start] - [Programs]* - [SonicStage] - [SonicStage].

* [All Programs] in the case of Windows XP

SonicStage starts up and the main window appears.

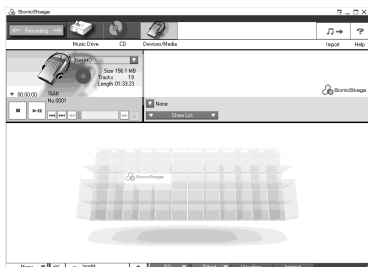

Recording audio CDs to the hard disk drive

In SonicStage Ver.1.5, the hard disk drive is called the “Music Drive”. The Music Drive manages all audio data stored by SonicStage.

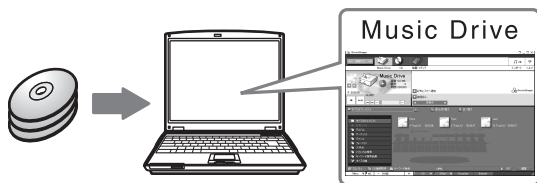

-
- 1 Insert the audio CD that you want to record into the CD-ROM drive of your computer.



The CD window appears in the display.

Note

When you record an audio CD from your CD-ROM drive for the first time, the “CD Drive Optimization” dialog box appears when you insert the audio CD. Clicking [Start] initiates a check of the CD-ROM drive to verify that the CD-ROM drive is able to perform the recording properly.

-
- 2 Click .

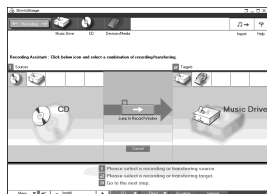

The recording navigation window* appears in the display.

*The recording navigation window makes it easy to make a recording. Simply by doing **1**, **2** and **3** in the next step, you can select the audio source in the left panel and the recording destination in the right panel.

-
- 3 Select  (CD) for [**1** Music Source] and  (Music Drive) for [**2** Destination], then click **3**  [Jump to Record Window].

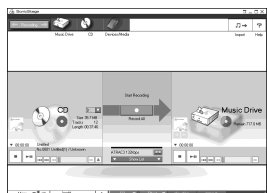

The display changes to the recording window.

-
- 4 Click **ATRAC3 132kbps**  in the middle of the recording window and select the recording mode.

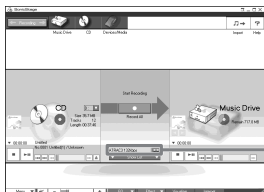

When recording data in LP2 mode:
select ATRAC3 132kbps

When recording data in LP4 mode:
select ATRAC3 66kbps

-
- 5 If the list panel is not displayed, click .



List panels appear under the recording window. The contents of the audio CD appear in the left list panel.

-
- 6 Click  [Record All].

Recording starts.

Upon completion, recorded tracks appear in the right list panel.

To stop recording

Click  ([Stop]).

To resume recording, click . When recording is resumed, it starts from the beginning of the track that was last stopped.

Labeling audio data

After recording has completed, you can label the audio data in the Music Drive. Once audio data in the Music Drive is labeled, the label information will be transferred to a disc along with the audio data, allowing you to view the data on your Net MD.

- 1 Start up SonicStage (page 46) and click  (Music Drive).



“All Playlists” appears and all the albums stored on the Music Drive appear in the Music Drive window.

- 2 Double click the desired album name.

A list of the audio files in that album appears.

- 3 Click  in the lower right part of the display.

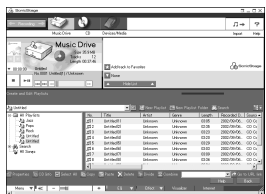



The editing panel appears in the display.

- 4 Select an item by clicking [Title], [Album], [Artist], or [Genre], and then right-click and select [Rename].

You can also click [▼] at [Album] or [Artist] to display a dropdown list, and then select an item from the list.

- 5 When the track title is highlighted, enter the text data from the keyboard.
-

 The  ([CD Info]) button for track and album labeling can also be used to import names from Internet databases. See the online help for details (page 54).

Transferring audio data from your computer to the Net MD (Check-out)

Audio data stored on the Music Drive can be transferred to your Net MD. This process is called “Check-out”. The number of times a track can be checked out is restricted in this software for the protection of copyrights (page 67).



Checking out audio files to the Net MD

This section explains how to check out all audio files in a playlist*.

* A playlist is a container that allows the stored audio files in the Music Drive to be classified by genre, artist, etc.

Note

Check-outs should be done at a temperature of +5 °C (+41 °F) or higher.

1 Click  to display the recording navigation window.

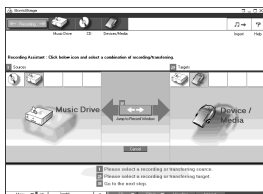

2 Select  (Music Drive) for [1 Music Source] and  (Device/Media) for [2 Destination], then click [3 ] ([Jump to Record Window]). The display changes to the recording window.

-
- 3 Click **Normal**  in the middle of the display and select the recording mode (page 48).

Standard transfer mode: Data are transferred in the format of the original files.

Maximum available transfer space: All data are transferred in LP4 mode.

SP transfer mode: All data are converted and transferred in normal stereo mode. Select this mode if you listen to checked-out data on equipment that does not support MDLP mode.



-
- 4 If the list panel is not displayed, click  .

A playlist appears in the display.



-
- 5 Confirm that the audio files you are about to check out are okay for checking out.



The music notations beside the track number in the left panel of the list represent the number of times the file can be checked out (e.g.  = the track can be checked out three more times). If  appears beside the track number, the file cannot be checked out.

-
- 6 Click  [Check-Out All].

Checking out of the files starts.

All files in the playlist are checked out to the connected Net MD.

To cancel a check-out

Click  ([Stop]).

Notes

- Make sure not to disconnect the dedicated USB cable or power source until the operation has completed once the check-out (or check-in) operation has begun. Failure to do this may result in the loss of check-out authorization. Even if a check-out fails, the audio file may be considered checked out on the SonicStage side and the file's check-out authorization may be reduced.
- Make sure not to bump the Net MD after check-out has started. If you do, the contents of the recording may not be stored correctly.
- Due to the limitations of the MD system, you may not be able to record the full amount of remaining recording time.
- Due to the limitations of the MD system, a maximum of about 1,700 characters can be stored for disc name, group names and track names on the disc. Take note of this fact when checking out a large number of tracks.

Listening to an MD

You can listen to an MD on the Net MD while it is connected to your computer. When disconnected from your computer, the Net MD can be used as an ordinary MiniDisc device.

For details on Net MD operations, refer to the “Recorder Operations” section.

Listening to an MD with the Net MD connected to the computer

If you listen to an MD with the Net MD connected to the computer, be sure to listen with the Net MD itself (connecting to the headphones/earphones, speakers, etc.). The MD sound cannot be heard from headphones/earphones that are connected to the computer.

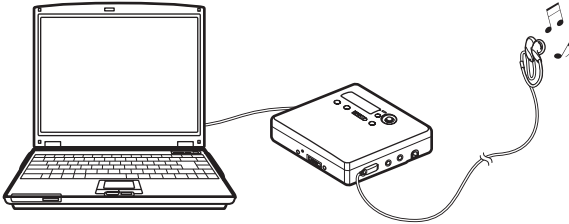

Listening to an MD with the Net MD disconnected from the computer

Listen to the MD after disconnecting the dedicated USB cable from the computer and the Net MD.

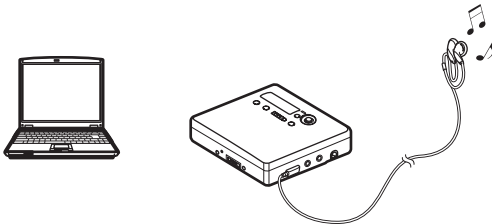

Notes

Generally, you cannot erase or divide/combine checked-out audio files. If you want to edit such files, check them back in first. Checked-out files can be edited on some MD devices; however, erasing a track will decrease the number of times the file can be checked out, and dividing or combining tracks will render the file impossible to check back into the computer (page 66).

Using other functions!

Using the SonicStage online help

This manual explains only the basic operations of the SonicStage software. However, the software has a host of other functions that allow you to carry out various operations, such as importing audio files from the Internet, classifying and managing audio files, and playing in various play modes. For information and details on the various menus and operations, go to the online help.

To display online help



Click  (help) while the SonicStage software is running.



You can display the online help by selecting the following:
[Start]–[Programs]*–[SonicStage]–[SonicStage Help]

* [All Programs] in the case of Windows XP.

Viewing online help

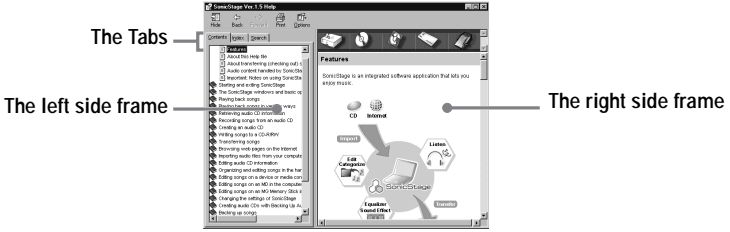

Let's find out how to use the online help first. An explanation on the use of the online help can also be found in the online help.

1 Double click [Overview] in the left-hand frame.

2 Click [About this Help file].

The explanation will appear in the right-hand frame.

3 Read the text.

Scroll the display if necessary.

Click underlined words to jump to their explanations.

Note

In the online help, "Device/Media" is the general term for external devices such as Net MDs and MusicClips.

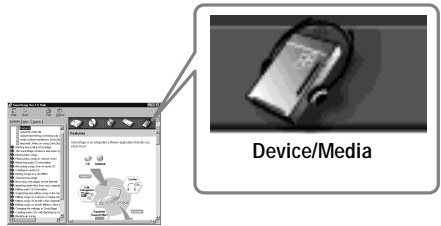

Settings and Precautions

Settings according to OS

The settings and precautions will differ according to the operating system being used. Check the items that apply to your system.

 For Windows XP users

Restrictions when running the SonicStage software under Windows XP

- To install this software, you must log on with a user name with “Computer Administrator”* as an attribute.
- You must log on with the user name “Administrators” or “Power Users” to use the SonicStage software.
- Both edition of Windows XP (Home/Professional) can be used.
- The NTFS format of Windows XP Home Edition or Windows XP Professional (factory installed) can be used only with the standard (factory) settings.

* To check whether the user name has the attribute of “Computer Administrator”
Go to [Start]- [Control Panel]-[User Account], and then check the user name displayed on the window.

When using SonicStage under Windows XP

If you use the “System Restore” function in Windows “System Tools”, audio data managed by SonicStage may become corrupted and rendered unplayable.

Before executing the system restoration procedure, you should first back up all audio files and restore them after doing the system restoration procedure.

For details about backup procedures, refer to online help.

Note

Restoring backup data requires access to the Internet. If an audio file becomes unplayable after restoring the system, an error dialog box may appear. If this occurs, do as instructed by the message.

 For Windows Millennium Edition users

When using SonicStage under Windows Millennium Edition

If you use the “System Restore” function in Windows “System Tools”, audio data managed by SonicStage may become corrupted and rendered unplayable.

Before executing the system restoration procedure, you should first back up all audio files and restore them after doing the system restoration procedure.

For details about backup procedures, refer to online help.

Note

Restoring backup data requires access to the Internet. If an audio file becomes unplayable after restoring the system, an error dialog box may appear. If this occurs, do as instructed by the message.

 For Windows 2000 users

Restrictions when running the SonicStage software under Windows 2000

- You must log on as “Administrator” to install the SonicStage software.
- You must log on with the user name “Administrators” or “Power Users” to use the SonicStage software.
- Of the Windows 2000 versions, SonicStage is supported only by Windows 2000 Professional.
- The NTFS format of Windows 2000 Professional (factory installed) can be used only with the standard (factory) settings.

 For Windows 98 Second Edition users

Importing MP3 files to the computer or playing WAV files on the computer

Microsoft Media Player version 7.0 or higher is required for importing MP3 files or playing WAV files. Users of earlier versions can download the most recent version from the Microsoft website (<http://www.microsoft.com/>).

For users with OpenMG Jukebox, SonicStage, SonicStage Premium, or SonicStage Simple Burner installed on their computer

Note

Confirm whether any tracks have been checked out from your computer. If tracks have been checked out from OpenMG Jukebox, an earlier version of SonicStage, or SonicStage Premium, it may not be possible to check those tracks back in with SonicStage Ver.1.5. It is recommended to check in the tracks before installing SonicStage Ver.1.5.

Check the following contents before installing SonicStage Ver.1.5.

The installation items and procedure will vary depending on the software installed on your computer.

Users with OpenMG Jukebox installed

Installed Version	What to do
Ver.1.0~2.1	Install SonicStage 1.5. OpenMG Jukebox Ver.1.0-2.1 is automatically uninstalled and replaced. ¹⁾
Ver.2.2	OpenMG Jukebox Ver.2.2 and SonicStage Ver.1.5 can co-exist in the computer. If you install SonicStage Ver.1.5, then OpenMG Jukebox Ver.2.2 will be automatically upgraded to the latest version.

¹⁾ Audio files recorded with OpenMG Jukebox Ver.1.0-2.1 are automatically converted to SonicStage Ver.1.5 files. For safety sake, it is recommended that you back up your audio data with the back-up tool before doing the upgrade to SonicStage Ver.1.5.

Users with an earlier version of SonicStage installed

Installed Version	What to do
Ver.1.0~1.5	Install SonicStage Ver.1.5. The earlier version is automatically uninstalled and replaced. ¹⁾

¹⁾ Audio files recorded with SonicStage Ver.1.0-1.5 are automatically converted to SonicStage Ver.1.5 files. For safety sake, it is recommended that you back up your audio data with the back-up tool before doing the upgrade to SonicStage Ver.1.5.

Users with a SonicStage Premium installed

Installed Version	What to do
SonicStage Premium	Install SonicStage Ver.1.5. SonicStage Premium and SonicStage Ver.1.5 can co-exist in the computer.

Users with a SonicStage Simple Burner installed

Installed Version	What to do
SonicStage Simple Burner	Install SonicStage Ver.1.5. SonicStage Simple Burner and SonicStage Ver.1.5 can co-exist in the computer.

Precautions on the co-existence of SonicStage Ver. 1.5 with OpenMG Jukebox Ver.2.2 or SonicStage Premium

- Make sure the OpenMG Jukebox Ver.2.2 icon is not displayed in the task tray. If it is, the Net MD may not be recognized by your computer.
- Audio data recorded on the computer are stored in a common file and used by both applications. Therefore, if you delete an audio file (e.g., one album) in one application, it will be deleted in the other software as well.

Precaution on using a computer on which OpenMG Jukebox Ver.1.0-2.1 or SonicStage Ver.1.0-1.2 is installed

After installing SonicStage Ver. 1.5, make sure you do not replace SonicStage Ver.1.5 with OpenMG Jukebox Ver.1.0-2.1 or SonicStage Ver.1.0-1.2, as all audio data in the Music Drive may be lost. If you begin the installation of OpenMG Jukebox Ver.1.0-2.1 or SonicStage Ver.1.0-1.2 by mistake, stop the installation immediately.

Note on hard disk drive space

120 MB or more free space on the hard disk drive is required. If your computer does not have enough space, the software will not be properly installed. The required free space differs according to the version of your Windows OS, or the amount of audio files that you handle.

Notes on system suspend/hibernation mode

- If the computer changes to system suspend/hibernation mode during the recording of a CD or the checking in/out of a data file, the audio data may be lost or the computer may not wake up properly. The computer suspend/hibernation function should therefore be turned off.
- If you change the media while the computer is in system suspend/hibernation mode, audio data may be lost after the computer wakes up.
- If the computer changes to system suspend/hibernation mode, the computer may not recognize the Net MD when it wakes up. If this happens, disconnect the dedicated USB cable and reconnect it again.

Backing up the audio data

Before doing any procedure that may affect the operating system itself (such as a system recovery), you should back up all of your audio data with the [SonicStage backup tool] from the [Start] - [Programs] - [SonicStage].

Uninstalling the SonicStage software

To uninstall the SonicStage software, follow the procedures below.

For Windows XP users

Log on with a user name with “Computer Administrator” as an attribute. Refer to the operating instructions of your computer for details on logging on as an administrator.

-
- 1 Click [Start]–[Control Panel].
The “Control Panel” window appears.

 - 2 Double-click [Add/Remove Programs].
The “Add/Remove Programs” dialog box appears.

 - 3 Click [Change or Remove Programs].

 - 4 Click [SonicStage 1.5.XX] in the “Currently Installed Programs” list, and then click [Change and Remove].

 - 5 Click [OpenMG Secure Module 3.X]* in the “Currently Installed Programs” list, and then click [Change and Remove].
Do as instructed by the message and restart the computer. When the computer restarts, the uninstallation will be completed.

* If SonicStage Ver.1.5 is co-existing with OpenMG Jukebox Ver.2.2 or SonicStage Premium on your computer, and you uninstall one or the other, make sure [OpenMG Secure Module 3.X] is not uninstalled since it is commonly used with both software applications.

For Windows Millennium Edition/Windows 98 Second Edition users

-
- 1 Click [Start]–[Settings]–[Control Panel].
The “Control Panel” window appears.
-

2 Double-click [Add/Remove Programs].
The Add/Remove Programs Properties window appears.

3 Click [SonicStage 1.5.XX] in the list of programs for automatic removal, and then click [Add/Remove].

4 Click [OpenMG Secure Module 3.X]* in the list of programs for automatic removal, and then click [Add/Remove].
Do as instructed by the message and restart the computer. When the computer restarts, the uninstallation will be completed.

For Windows 2000 users

Log on as “Administrator”, and then follow the instructions below.
Refer to the operating instructions of your computer for details on logging on as an administrator.

1 Click [Start]–[Settings]–[Control Panel].
The “Control Panel” window appears.

2 Double-click [Add/Remove Programs].
The “Add/Remove Programs” dialog box appears.

3 Click [Change or Remove Programs].

4 Click [SonicStage 1.5.XX] in the “Currently Installed Programs” list, and then click [Change/Remove].

5 Click [OpenMG Secure Module 3.X]* in the “Currently Installed Programs” list, and then click [Change/Remove].
Do as instructed by the message and restart the computer. When the computer restarts, the uninstallation will be completed.

* If SonicStage Ver.1.5 is co-existing with OpenMG Jukebox Ver.2.2 or SonicStage Premium on your computer, and you uninstall one or the other, make sure [OpenMG Secure Module 3.X] is not uninstalled since it is commonly used with both software applications.

Troubleshooting

Please do the following steps if you encounter a problem while using the SonicStage software. In case a message appears, it is recommended that you write it down.

Step 1: Check the symptoms in this “Troubleshooting” section.

A variety of information can also be found in the operating procedures and “Settings and Precautions” (page 56) as well.

Step 2: Check the symptoms in the SonicStage 1.5 online help (page 54).

Check “Troubleshooting” under “Additional information” in the online help. Useful information may also be found in other sections in the online help.

Step 3: If the trouble cannot be solved after checking the above references.

Check the following table and then consult your nearest Aiwa dealer.

Computer <ul style="list-style-type: none"> • Manufacturer: • Model: • Type: Desktop type / Laptop type
Name of operating system:
RAM capacity:
Hard disk drive (containing SonicStage and audio data) <ul style="list-style-type: none"> • Capacity of the drive: • Free space:
Installed folder containing SonicStage (if other than the default folder)¹⁾ <ul style="list-style-type: none"> • Location of the installed folder:
Version of the software (SonicStage Ver.1.5) ²⁾ :
Error Message (if one appeared):
If an externally connected CD-ROM drive is used <ul style="list-style-type: none"> • Manufacturer: • Model: • Type: CD-ROM / CD-R/RW / DVD-ROM / Other () • Type of connection to the computer: PC card / USB / IEEE1394 / Other ()
If another device with USB connection is used <ul style="list-style-type: none"> • Name of the device (or devices):

¹⁾ If you do not specify the destination, the software is installed at C:\Program Files\Sony\SonicStage.

²⁾ To check the SonicStage software version, go to [Menu] - [About SonicStage] in the SonicStage window, or see the version information on the supplied CD-ROM.

If your computer does not recognize the Net MD

- **Is the Net MD connected correctly to your computer?**

- If the Net MD is not firmly connected to the computer, the Net MD will not be recognized by your computer.
- Reconnect the dedicated USB cable. If the computer still does not recognize the Net MD, disconnect the Net MD, restart the computer, and connect the dedicated USB cable again.

- **Is an MD inserted in the Net MD?**

Check if an MD is inserted in the Net MD.

- **If your computer does not recognize your Net MD even when the Net MD is connected and a disc is inserted, the Net MD driver may not be correctly installed.**

Go to the [USB Controller] in the Windows Device Manager window to verify that your Net MD is correctly recognized.

A [!] mark in the Device Manager window indicates that your Net MD is not correctly recognized. Reinstall the Net MD driver.

1 Click [Start]–[Settings]–[Control Panel].¹⁾

2 Double click [System] in the control panel.²⁾

3 Click the [Hardware]³⁾ tab, and then click [Device Manager].

The Device Manager window appears.

¹⁾ In Windows XP, select [Start]–[Control Panel].

²⁾ In Windows XP, double click [System] if the control panel is in the “classic” format, or click [Performance and Maintenance] and then [System] if the control panel is in the “category” format.

³⁾ Depending on your system, the [Hardware] tab may not be provided. In this case, click the [Device Manager] tab to display the Device Manager window.

If the installation was not successful

- **Be sure to close all Windows applications before you start the installation.**

If you start the installation while other programs are running, a malfunction may occur. This is especially true for programs that require large amounts of system resources, such as virus-check software.

- **Be sure not to connect the Net MD to your computer before you start the installation.**

If the dedicated USB cable is connected to your computer before the installation, the installation cannot be done correctly. Connect the dedicated USB cable after the installation completed.

- **Make sure your computer has enough hard disk drive space.**

120 MB of free space or more on the hard disk drive is required. If your computer does not have enough space, the installation may not be possible.

- **If the installation seems to be stopped**

It may take 30 minutes or more for the installation to complete, depending on your computer or CD-ROM drive.

During the installation, watch out for the occurrence of any of the following problems.

Problem	Cause/Remedy
The installation appears to have stopped before it has completed.	Check for the appearance of an error message beneath the installation window. → Press the [Tab] key while holding down the [Alt] key. If an error message has appeared, press the [Enter] key. The installation will resume. If there is no message, the installation is still in progress. Wait a little while longer.
The progress bar on the display is not moving. The access lamp has not lit for a few minutes.	The installation is progressing normally. Please wait.

- **If the installation is still unsuccessful after all that you have done.**

— The installation can be done by copying all files to the hard disk as follows:

- 1 Create a new folder on the hard disc.
- 2 Insert the supplied CD-ROM (SonicStage Ver.1.5) into the CD-ROM drive.
- 3 When the installation window appears, click [Exit] to cancel the installation.
- 4 Right-click the start menu and start up Explorer.
- 5 Select [SS15E] on the CD-ROM drive, and then click [Edit] -[Select All].
- 6 Click [Edit]-[Copy to Folder] (or [Edit]-[Copy]) to copy all files to the folder that you created in step 1.
- 7 Remove the CD-ROM from the CD-ROM drive, open the folder that was copied to the hard disk and double-click [setup.exe].
- 8 When the installation window appears, follow the displayed instructions to install [SonicStage 1.5].

— The installation may be done by installing the software from [Start]-[Run].

Information and explanations

Net MD FAQ

This section introduces frequently asked questions and answers on the Net MD.

On the Net MD

What is a “Net MD”?

Net MD is a specification that allows audio data in a computer to be transferred to a MiniDisc through a USB cable.

Till now, MiniDiscs could be used to record only analog sources (through a microphone or analog input) or PCM sources such as CDs. Recording audio files on a computer was impossible. However, thanks to SonicStage and other music management software based on such copyright protection technology as “OpenMG”¹⁾ and “MagicGate”²⁾, conversion of audio files to the ATRAC or ATRAC3³⁾ format used on MDs became possible, enabling the recording of computer files to MDs.

- 1) Copyright protection technology for managing audio data recorded on computers, etc.
- 2) Technology for verifying the copyright-protection status of audio data in check-out/check-in operations between a computer and a Net MD device.
- 3) File type for recording to an MD.

How does the SonicStage software make using MDs more convenient?

- It allows you to record audio data from your computer to your MD.
- Editing operations are easily done using on-screen operations.
 - Labeling: Allows use of keyboard for easy labeling of contents.
 - Moving tracks or groups: Allows tracks or groups to be moved simply by dragging and dropping. Track movements are easy to see.
 - Group settings: Groups are easy to create or release.

These operations can be used to edit tracks on a disc in the Net MD. If you want to edit the contents of an MD, connect the Net MD to your computer, and edit the tracks in the SonicStage Device/Media window.

Can tracks recorded on the Net MD be checked in to a computer?

No, they cannot.

Audio data that was originally checked out from a computer can only be checked back into the same computer. Tracks that are recorded on the Net MD using a microphone or through an analog or digital connection cannot be transferred to the computer or copied.

Computer ⇔ MiniDisc : OK.

MiniDisc ⇔ Computer : OK only for tracks originally checked out from the computer.

On copyright protection

The OpenMG technology* allows you to enjoy digital music, while maintaining the copyrights of its holders. OpenMG Jukebox encrypts audio files in OpenMG format and stores them on the hard disk of your computer to prevent unauthorized distribution.

* The copyright protection technology of this software conforms to SDMI (Secure Digital Music Initiative) specifications.

This software places some restrictions on recording and playback to protect copyrights.

You can check in audio files only to the same computer from which they were checked out.

They cannot be copied or checked in to other computers.

For details, see “Features by copyright protection by OpenMG” (page 68).

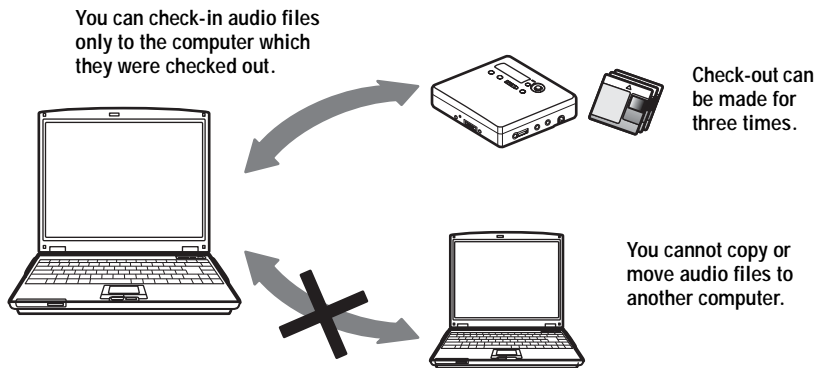

Restrictions on audio content

High-quality digital audio content is widely available through music distribution services on the Internet. To protect the copyrights of its holders from unauthorized distribution, some audio content is distributed with certain restrictions on recording and playback. For example, the playback period or playback count for the data may be limited. In such cases, checking out of the audio contents may not be possible.

Depending on the contents, some audio data that could be checked out are subject to editing restrictions on the Net MD; e.g., audio contents cannot be erased or track marks cannot be added or erased.

It is not possible to check in tracks other than those that were checked out from your computer (for example, tracks recorded using a microphone or through analog or digital connection).

Features by copyright protection by OpenMG

The SonicStage software features OpenMG, a copyright protection technology developed by Sony to protect music copyrights. OpenMG uses high-level cryptographic technology to protect music contents with computers.

Users should be aware of the restrictions described below.

- Music recorded on the hard disk using the SonicStage software cannot be played when copied to other computers.
- Installation of the same SonicStage software to other computers is not permitted.

• Usage Rules

If Usage Rules are included in the music by way of the copyright holder or the distributor, operation will be restricted to use permitted by the Usage Rule. For music, such as compact discs, that does not contain a Usage Rule, the Default Usage Rule of SDMI will apply. This Default Usage Rule states that one file can be checked out up to three times only.

- On music contents that are not compatible with the SonicStage software
Under the supervision of SDMI, this software prohibits recording of music with a copy prohibition signal.
- Upgrading SonicStage software
This software was developed in accordance with the current arrangement between Sony and SDMI. If this arrangement is modified in the future, some of the software functions may become unavailable. Sony may offer an upgrade kit in this case at additional user expense.

Glossary

ATRAC3

ATRAC3, which stands for Adaptive Transform Acoustic Coding³, is audio compression technology that satisfies the demand for high sound quality and high compression rates. The ATRAC3 compression rate is approximately 10 times higher than that of the Audio CD, resulting in an increased data capacity for the media.

“Check-In /Check-Out”

Check-out is to transfer music files from a personal computer to an external device/media (such as a Net MD). Returning checked-out music files to the same computer is to check in. (You cannot move checked-out music files to another computer.)

You can check out a music file, check it back in, and then check it out again an infinite number of times. The SDMI rules provide that up to four copies of a music file can be checked out at one time. OpenMG employs a method whereby three copies of a song can be checked out simultaneously, while the fourth copy is maintained as a master on your PC.

Electronic Music Distribution (EMD) service*

EMD is a website that distributes music files which are available for purchase.

The use of EMD services requires installation of player software on your computer. Audio files should be downloaded in a format that is supported by the SonicStage software (such as Label Gate MQ format). For details on EMD services support by SonicStage, please contact to the respective companies.

* EMD may not be available in certain areas of the world.

MP3

MP3, which stands for MPEG-1 Audio Layer³, is a standard for audio file compression determined by the Motion Picture Experts Group, an ISO (International Organization for Standardization) working group. It enables compression of audio files to about 1/10 of the data size of a standard compact disc. Since the MP3 encoding algorithm is disclosed, there are various encoders/decoders that are compliant with this standard, including freeware that is available for no charge. The MP3 standard is therefore widely used in the computer field.

Music Drive

Music Drive is a music database for managing audio data on a computer. In Music Drive, audio files can be managed along with such information as artist names, track names, and CD jacket images, or can be combined and categorized in different playlists.

OpenMG

Copyright protection technology for the import and management of musical content from distribution services or CDs. By using software that are compliant with OpenMG, audio contents can be encrypted before storage on a hard disk drive to allow playback of those audio files on that computer. OpenMG also prevents the unauthorized distribution of the contents via the Internet or other networks.

continued

Playlist

A playlist is like a container that can be used to hold and categorize files stored in Music Drive. For example, by making a “jazz” playlist and then putting your favorite jazz tracks into the playlist, you can play all of the tracks repeatedly or check them all out at the same time.

Recording mode (Bit rate)

This is a measure of data volume per second. The rate is expressed in bps (bits per second). In SonicStage, the bit rate can be selected for recording an audio CD or converting MP3 and WAV format audio files into ATRAC3 format from among three rates: 132 kbps, 105 kbps or 66 kbps. In the case of 105 kbps, 105,000 bits of information is processed per second. If the bit rate is large, that means a large amount of information is used to play the music. Thus, 105 kbps data produces better sound quality than 66 kbps data, and 132 kbps data provides better sound quality than 105 kbps data. However, audio files in formats such as MP3 have different encoding methods, and so the sound quality is not determined by the bit rate alone.

SDMI

SDMI, which stands for Secure Digital Music Initiative, is a forum that consists of over 130 companies in the fields of recorded audio content, computers, and consumer electronics. It is dedicated to the development of integrated copyright protection technology that can be used worldwide.

SDMI is working to create a framework for preventing the improper usage of audio files and to promote legal music distribution services. The copyright protection technology OpenMG is based on the SDMI standard.

Windows Media Technology (WMT)

This is a technology that includes a contents management system called Windows Media Rights Manager which encrypts contents and distributes music contents along with their conditions for usage, distribution, etc. Copyright-protected audio files supported by Windows Media Technology (WMT) cannot be converted to the ATRAC3 format and coded in the OpenMG format.

Windows Media Audio (WMA)

This is an audio compression technology that includes the management system called “Windows Media Rights Manager”. Windows Media Audio (WMA) format files supported by Window Media Technology (WMT) cannot be converted to the ATRAC3 format and coded in the OpenMG format.

Index

- A
 - ATRAC3 66, 69
 - Audio CD 38, 47
- B
 - back up 59
 - Battery life 29
 - BEEP 27
- C
 - CD-ROM 41
 - Check-in 66, 69
 - Check-out 50, 66, 69
 - Cleaning 31
 - Connecting 45
 - copyright protection 67
- D
 - delete (software) 60
 - Device/Media 50, 55
 - Digital Sound Preset 22
 - DSP TYPE-S 36
- E
 - E • A • S • S GP 20
 - EAR G. (Ear Guard) 28
 - EMD services 69
- G
 - Group
 - function 24
 - play 24
 - skip 24
- H
 - hard disk
 - free space 41, 59
 - storing 47
 - HOLD 15, 28
- I
 - Index search 20
 - Installing 43
- L
 - labeling 49
- M
 - MP3 69
 - Music Drive 47, 69
- N
 - Net MD 39, 66
 - Net MD driver 64
- O
 - Online help 54
 - OpenMG 69
 - OpenMG Jukebox software 42, 58
- P
 - Play mode
 - group 25
 - tracks 21
 - Playlist 50, 71
- Q
 - Quick Mode 27
- R
 - Recording mode (Bit rate) 48, 51, 70
 - Recording navigation window 47
- S
 - SDMI 70
 - SonicStage Premium 42, 58
 - SonicStage software (earlier version) 42, 58
 - start (software) 46
 - Supplied accessories 12
 - System environment 41
 - System limitations 41
- T
 - Time search 20
 - Transferring
 - to the computer 46
 - to the Net MD 50
- U
 - Uninstalling
 - Windows 2000 61
 - Windows 98 Second Edition 60
 - Windows Millennium Edition 60
 - Windows XP 60
 - USB cable 12
- W
 - Windows 2000 61
 - Windows 98 Second Edition 60
 - Windows Millennium Edition 60
 - Windows XP 60
 - WMA 70
 - WMT 70



Printed using VOC (Volatile Organic
Compound)-free vegetable oil ink.

<http://www.aiwa.com/>

Printed in Malaysia