

SHARP

MD/CD STEREO

MODEL
MD-X5

OPERATION MANUAL

Thank you for purchasing this SHARP product. To obtain the best performance from this product please read this manual carefully. It will guide you in operating your SHARP product.

MD-X5 MD/CD stereo consisting of MD-X5 MD/CD stereo CP-X5 2 way speaker system.



COMPACT disc
DIGITAL AUDIO

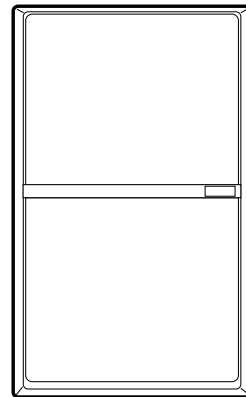
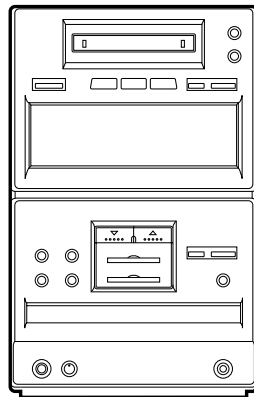
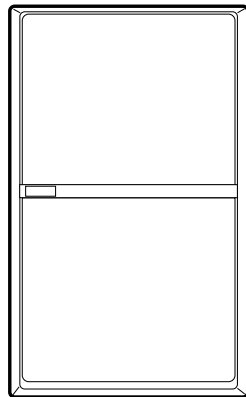

CONTENTS

	Page		Page
IMPORTANT SAFEGUARDS	1	RECORDING	17 - 19
SPECIAL NOTES	1 - 2	EDITING	20 - 26
PRECAUTIONS	2	ENTERING CHARACTERS	27 - 28
NAMES OF CONTROLS AND INDICATORS	3 - 4	HOW TO USE THE BUILT-IN TIMER	29 - 32
PREPARATION FOR USE	5 - 6	USING EXTERNAL UNITS	33 - 36
SOUND CONTROL	7	WHAT IS A MINIDISC?	37
SETTING THE CLOCK	8	MINIDISC SYSTEM LIMITATIONS	38
COMPACT DISC OPERATION	9	TROUBLESHOOTING	38 - 40
MINIDISC OPERATION	10	MAINTENANCE	41
RADIO OPERATION	11 - 12	SPECIFICATIONS	41
CD AND MD OPERATIONS	13 - 15	CALLING FOR SERVICE	Back cover
BASIC INFORMATION ON MINIDISCS	16	LIMITED WARRANTY	Back cover

ACCESSORIES

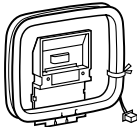
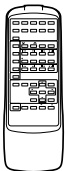
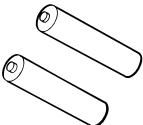
 <p>FM/AM loop antenna x 1 [QANTL0004AWZZ]</p>	 <p>Remote control x 1 [RRMCG0110AWSA]</p>	 <p>"AA" size battery (UM/SUM-3, R6, HP-7 or similar) x 2 [UBATU0001AWZZ]</p>
---	---	--

Note:
Parts and accessories mentioned in this operation manual other than those detailed above are not included.



The lightning flash with arrowhead symbol, within an equilateral triangle, is intended to alert the user to the presence of uninsulated "dangerous voltage" within the product's enclosure that may be of sufficient magnitude to constitute a risk of electric shock to persons.

CAUTION

**RISK OF ELECTRIC SHOCK
DO NOT OPEN**

CAUTION: TO REDUCE THE RISK OF ELECTRIC SHOCK, DO NOT REMOVE COVER (OR BACK). NO USER-SERVICEABLE PARTS INSIDE. REFER SERVICING TO QUALIFIED SERVICE PERSONNEL.



The exclamation point within an equilateral triangle is intended to alert the user to the presence of important operating and maintenance (servicing) instructions in the literature accompanying the appliance.

IMPORTANT SAFEGUARDS

CAUTION

All the safety and operating instructions should be read before the appliance is operated, and should be retained for future reference. Electrical energy can perform many useful functions. This unit has been engineered and manufactured to assure your personal safety. Improper use can result in potential electrical shock or fire hazards. In order not to defeat the safeguards, observe the following basic rules for its installation, use and servicing.

- 1 Heed Warnings - All warnings on the appliance and in the operating instructions should be adhered to.
- 2 Follow Instructions - All operating and use instructions should be followed.
- 3 Water and Moisture - The appliance should not be used near water - for example, near a bathtub, washbowl, kitchen sink, laundry tub, in a wet basement, or near a swimming pool, etc.
- 4 Carts and Stands - The appliance should be used only with a cart or stand that is recommended by the manufacturer.
 - An appliance and cart combination should be moved with care. 
 - Quick stops, excessive force, and uneven surfaces may cause the appliance and cart combination to overturn.
- 5 Wall or Ceiling Mounting - The appliance should be mounted to a wall or ceiling only as recommended by the manufacturer.
- 6 Ventilation - The appliance should be situated so that its location or position does not interfere with its proper ventilation. For example, the appliance should not be situated on a bed, sofa, rug, or similar surface that may block the ventilation openings; or, placed in a built-in installation, such as a bookcase or cabinet that may impede the flow of air through the ventilation openings.
- 7 Heat - The appliance should be situated away from heat sources such as radiators, heat registers, stoves, or other appliances (including amplifiers) that produce heat.
- 8 Power Sources - The appliance should be connected to a power supply only of the type described in the operating instructions or as marked on the appliance.
- 9 Power-Cord Protection - Power-supply cords should be routed so that they are not likely to be walked on or pinched by items placed upon or against them, paying particular attention to cords at plugs, convenience receptacles, and the point where they exit from the appliance.
- 10 Do not use liquid cleaners or aerosol cleaners. Use a damp cloth for cleaning.
- 11 Power Lines - An outdoor antenna should be located away from power lines.

12 Outdoor Antenna Grounding - If an outside antenna is connected to the receiver, be sure the antenna system is grounded so as to provide some protection against voltage surges and built-up static charges. Article 810 of the National Electrical Code, ANSI/NFPA 70, provides information with regard to proper grounding of the mast and supporting structure, grounding of the lead-in wire to an antenna discharge unit, size of grounding conductors, location of antenna-discharge unit, connection to grounding electrodes, and requirements for the grounding electrode.

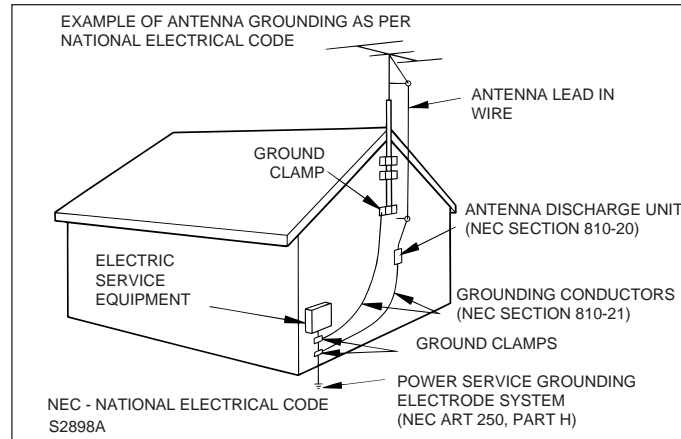

- 13 Non use Periods - The power cord of the appliance should be unplugged from the outlet when left unused for a long period of time.
- 14 Object and Liquid Entry - Care should be taken so that objects do not fall and liquids are not spilled into the enclosure through openings.
- 15 Damage Requiring Service - The appliance should be serviced by qualified service personnel when:
 - A The power-supply cord or the plug has been damaged; or
 - B Objects have fallen, or liquid has been spilled into the appliance; or
 - C The appliance has been exposed to rain; or
 - D The appliance does not appear to operate normally or exhibits a marked change in performance; or
 - E The appliance has been dropped, or the enclosure damaged.
- 16 Servicing - The user should not attempt to service the appliance beyond that described in the operating instructions. All other servicing should be referred to qualified service personnel.
- 17 Grounding or Polarization - Precautions should be taken so that the grounding or polarization means of an appliance is not defeated.

SPECIAL NOTES

FOR YOUR RECORDS

For your assistance in reporting this unit in case of loss or theft, please record below the model number and serial number which are located on the rear of the unit.

Please retain this information.

Model number _____
 Serial number _____
 Date of purchase _____
 Place of purchase _____



(Continued)

Caution - use of controls or adjustments or performance of procedures other than those specified herein may result in hazardous radiation exposure.

Note:

This equipment has been tested and found to comply with the limits for a Class B digital device, pursuant to Part 15 of the FCC Rules. These limits are designed to provide reasonable protection against harmful interference in a residential installation.

This equipment generates, uses, and can radiate radio frequency energy and, if not installed and used in accordance with the instructions, may cause harmful interference to radio communications.

However, there is no guarantee that interference will not occur in a particular installation. If this equipment does cause harmful interference to radio or television reception, which can be determined by turning the equipment off and on, the user is encouraged to try to correct the interference by one or more of the following measures:

- Reorient or relocate the receiving antenna.
- Increase the separation between the equipment and receiver.
- Connect the equipment into an outlet on a circuit different from that to which the receiver is connected.
- Consult the dealer or an experienced radio/TV technician for help.

WARNING: TO REDUCE THE RISK OF FIRE OR ELECTRIC SHOCK, DO NOT EXPOSE THIS APPLIANCE TO RAIN OR MOISTURE.

WARNING

FCC Regulations state that any unauthorized changes or modifications to this equipment not expressly approved by the manufacturer could void the user's authority to operate this equipment.

SPECIAL NOTES FOR FCC COMPOSITE DEVICE:

This device is a composite system. The digital device component may not cause harmful interference.

- It is the intent of Sharp that this product be used in full compliance with the copyright laws of the United States and that prior permission be obtained from copyright owners whenever necessary.

US and foreign patents licensed from Dolby Laboratories Licensing Corporation.

PRECAUTIONS

General

- Do not use oil, solvents, gasoline, paint thinner or insecticides on the unit.
- Do not expose the unit to moisture, to temperatures higher than 140°F (60°C) or to extreme low temperatures.
- Keep the unit away from direct sunlight, strong magnetic fields, excessive dust, humidity and electronic/electrical equipment (home computers, facsimiles, etc.) which generates electrical noise.
- Hold the AC power plug by the head when removing it from the AC outlet, since pulling the cord can damage internal wires.
- Use the unit on a firm, level surface free from vibration.
- If the unit does not work properly while in use, press the POWER button to turn the power off, then disconnect the AC power cord from the AC outlet. Plug the AC power cord back in, and then press the POWER button to turn the power on.
- If an electrical storm is taking place near you, it is suggested that you disconnect the AC power cord from the AC outlet for safety.
- Before moving the unit, be sure to remove all CDs and MDs from the unit. Then, turn the power off and unplug the AC power cord. If you move the unit with CDs or MDs left in it, they may jam inside the unit, leading to damage.

Warning:

The voltage used must be the same as that specified on this unit. Using this product with a higher voltage than that which is specified is dangerous and may result in a fire or other type of accident causing damage. SHARP will not be held responsible for any damage resulting from use of this unit with a voltage other than that which is specified.

Volume control

The sound level at a given volume setting depends on a combination of speaker efficiency, location and many other factors.

It is advisable to avoid exposure to high volume levels, which occur while turning the unit on with the volume control setting up high, or while continually listening at high volumes.

Condensation

Sudden temperature changes and storage or operation in an extremely humid environment may cause condensation inside the cabinet. Condensation can cause the unit to malfunction. Follow the procedure below to eliminate condensation.

CD and MD pickups

Leave the power on with no disc in the unit until normal playback is possible (about 1 hour).

Remote control

Wipe off any condensation on the transmitter LED with a soft cloth before operating the unit.

Care of compact discs

Compact discs are fairly resistant to damage, however mistracking can occur due to an accumulation of dirt on the disc surface. Follow the guidelines below for maximum enjoyment from your CD collection and player.

- Do not write on either side of the disc, particularly the non-label side. Signals are read from the non-label side. Do not mark on this surface.
- Keep your discs away from direct sunlight, heat, and excessive moisture.
- Always hold CDs by the edges. Fingerprints, dirt, or water on the CDs can cause noise or mistracking. If a CD is dirty or does not play properly, clean it with a soft, dry cloth, wiping straight out from the center, along the radius.

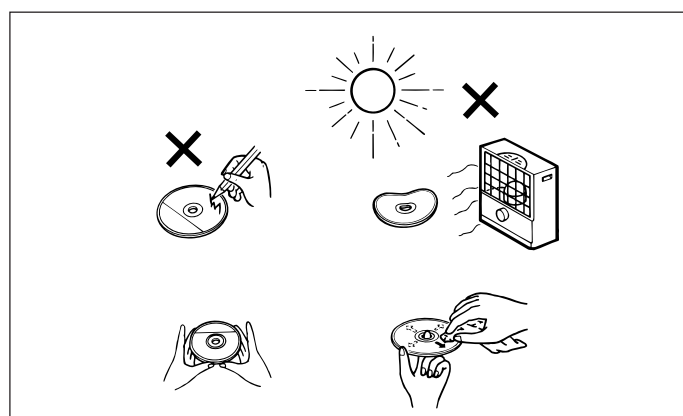



NAMES OF CONTROLS AND INDICATORS

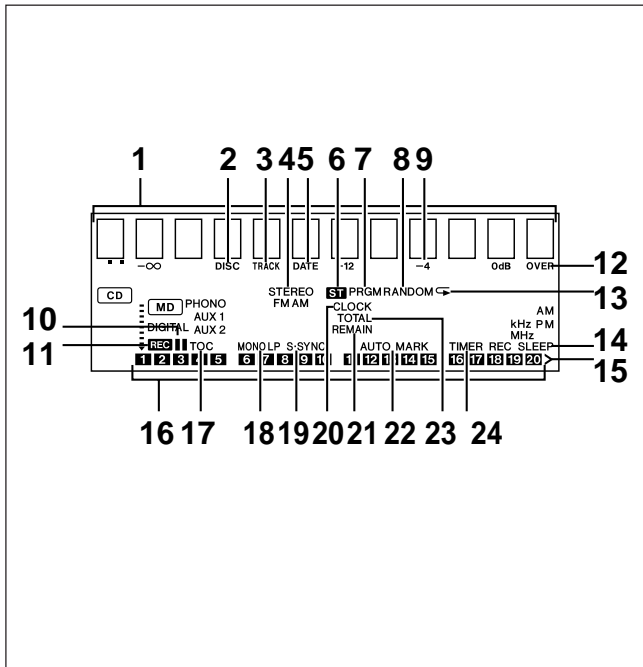

● Display window

1. Level Meter/Character Information Display
2. Disc Name Indicator: DISC
3. Track Name Indicator: TRACK
4. FM Stereo Mode Indicator: STEREO
5. Date Indicator: DATE
6. FM Stereo Indicator: ST
7. Program Indicator: PRGM
8. Random Play Indicator: RANDOM
9. Recording Level Indicator
10. MD Pause Indicator: ||
11. MD Record Indicator: REC
12. Recording Level Too High Indicator
13. Repeat Indicator: ⏮
14. Sleep Indicator: SLEEP
15. More Tracks Indicator: >
16. Music Schedule Indicators
17. MD TOC Indicator: TOC
18. Recording Mode Indicator: MONO LP
19. Sound Synchro Indicator: S. SYNC
20. Clock Indicator: CLOCK
21. Remaining Time Indicator: REMAIN
22. Auto Mark Indicator: AUTO MARK
23. Total Time Indicator: TOTAL
24. Timer/Timer Record Indicator

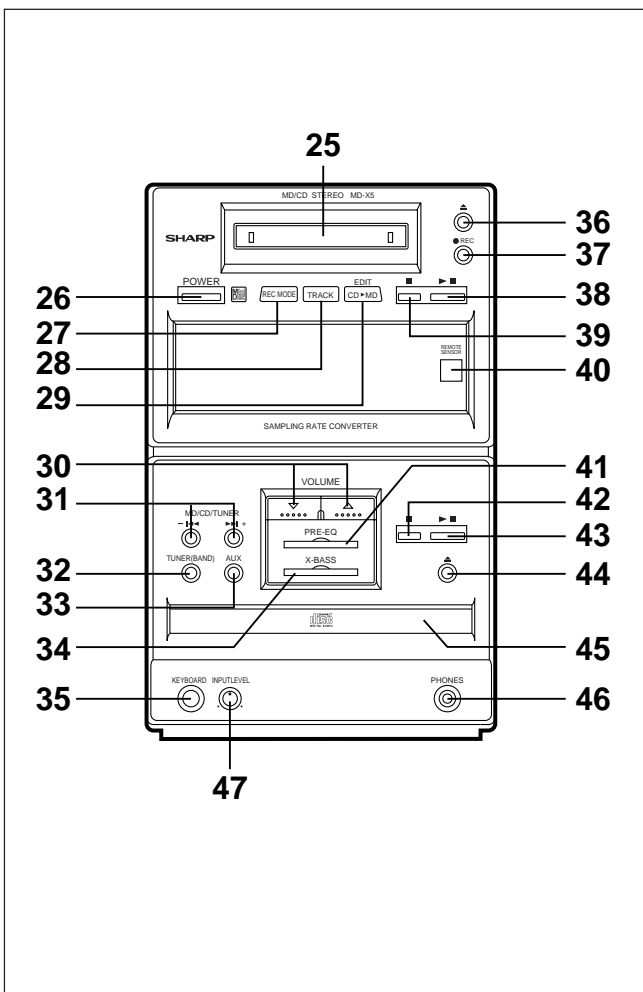

● Front panel

25. MD Slot
26. Power Button: POWER
27. Recording Mode Button: REC MODE
28. CD Track Select Button: TRACK
29. CD ▶ MD Edit Button
30. Volume Up/Down Buttons: ▽/△
31. ⏮ / ⏭ .-/± Buttons
32. Tuner Call (Band Select) Button: TUNER(BAND)
33. Auxiliary Select Button: AUX
34. Extra Bass Button: X-BASS
35. Keyboard Input Terminal
36. MD Eject Button: ▲
37. MD Record Button: ● REC
38. MD Play/Pause Button: ▶||
39. MD Stop Button: ■
40. Remote Sensor
41. Pre-program Equalizer Button: PRE-EQ
42. CD Stop Button: ■
43. CD Play/Pause Button: ▶||
44. CD Open/Close Button: ▲
45. CD Tray
46. Headphones Jack: PHONES
47. Input Level Control: INPUT LEVEL



(Continued)

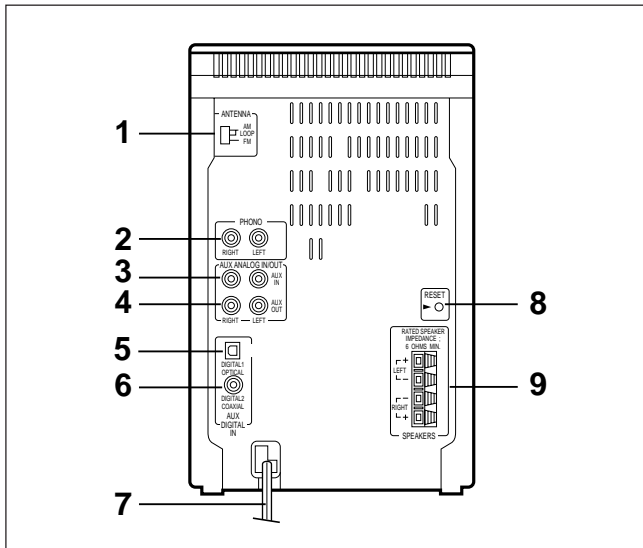

● Rear panel

1. AM Loop/FM Antenna Jack
2. Phono Input Jacks
3. Auxiliary Analog Input Jacks
4. Auxiliary Analog Output Jacks
5. Auxiliary Digital Input Jack (Optical)
6. Auxiliary Digital Input Jack (Coaxial)
7. AC Power Cord
8. Reset Button
9. Speaker Terminals

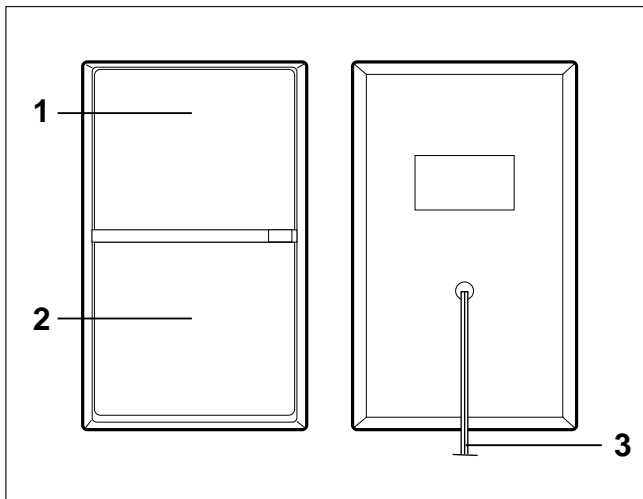

● Speaker section

1. Tweeter
2. Woofer
3. Speaker Cord

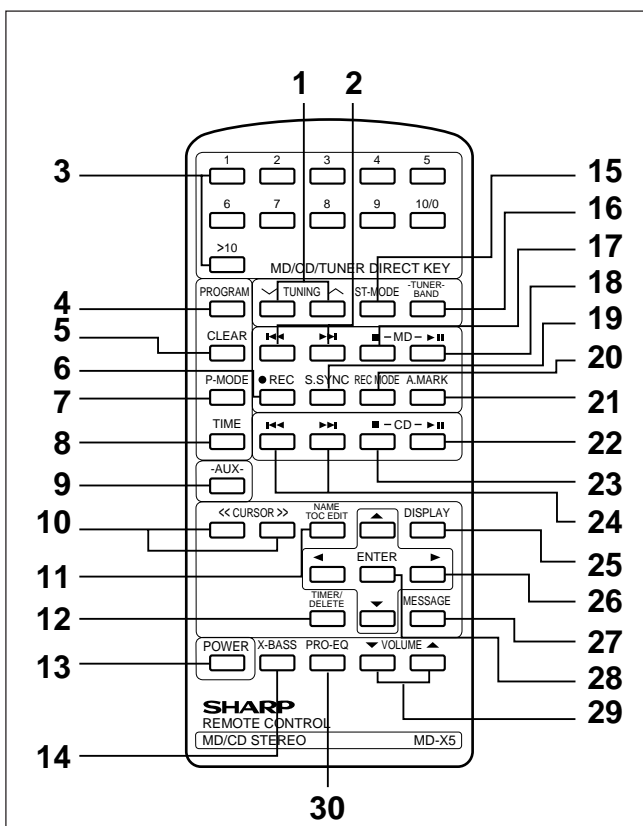

● Remote control

1. Tuning Up/Down Buttons: ∇/\wedge
2. MD Track Up/Down, Cue/Review Buttons: \lll/\ggg
3. Tuner Preset/CD/MD Track Number Input Buttons
4. Program Button: PROGRAM
5. Clear Button: CLEAR
6. MD Record Button: ● REC
7. Play Mode Button: P-MODE
8. Time Display Select Button: TIME
9. Auxiliary Select Button: AUX
10. Cursor Buttons: CURSOR
11. Name/TOC Edit Button: NAME/TOC EDIT
12. Timer/Delete Button: TIMER/DELETE
13. Power Button: POWER
14. Extra Bass Button: X-BASS
15. FM Stereo Mode Button: ST-MODE
16. Tuner Call (Band Select) Button: TUNER/BAND
17. MD Stop Button: ■
18. MD Play/Pause Button: $\blacktriangleright\parallel$
19. Sound Synchro Button: S. SYNC
20. Recording Mode Button: REC MODE
21. Auto Mark Button: A.MARK
22. CD Play/Pause Button: $\blacktriangleright\parallel$
23. CD Stop Button: ■
24. CD Track Up/Down, Cue/Review Buttons: \lll/\ggg
25. Display Button: DISPLAY
26. $\blacktriangle/\blacktriangledown/\blacktriangleleft/\blacktriangleright$ Buttons
27. Message Button: MESSAGE
28. Enter Button: ENTER
29. Volume Up/Down Buttons: ∇/\wedge
30. Pre-program Equalizer Button: PRE-EQ





PREPARATION FOR USE

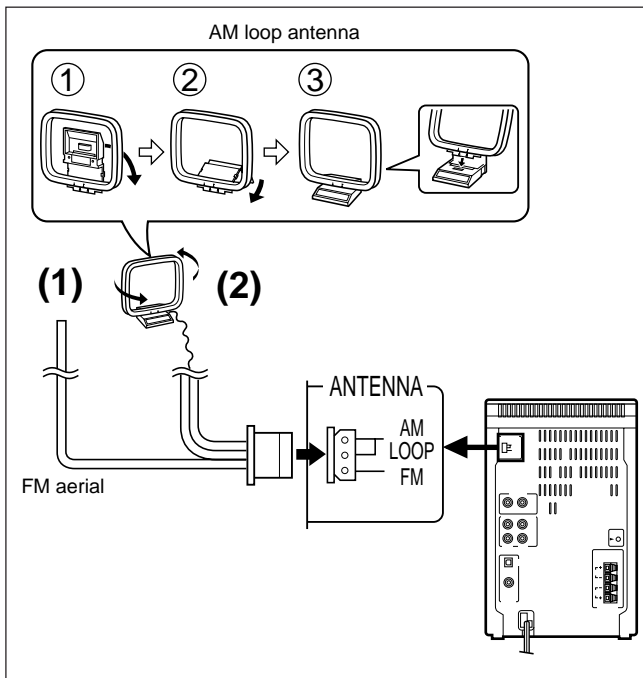

- Unplug the AC power cord from the AC outlet before connecting or disconnecting any component.

Antenna connection

Connect the antenna wire to the ANTENNA jack.

(1) FM antenna

Position the FM antenna wire in the direction where the strongest signal can be received.

(2) AM loop antenna

Position the AM loop antenna for optimum reception. Place the AM loop antenna on a shelf, etc., or attach it to a stand or wall with screws (not supplied).

Notes:

- Do not place the antenna on the unit. It may result in noise generation, since the unit is equipped with digital electronics. Place the antenna away from the unit for better reception.
- If the AM loop antenna and the FM antenna wire are placed near the AC power cord, interference may result.

Speaker connection

Connect each speaker wire to the SPEAKER terminals as shown. Use speakers with an impedance of 6 ohms or more, as lower impedance speakers can damage the unit.

Cautions:

- Connect the black wire to the minus (-) terminal, and the red wire to the plus (+) terminal.
- Do not mix the right channel and left channel wiring when connecting the speakers to the unit.
- Do not let bare speaker wires touch each other as this may damage the amplifier and/or speakers.

Note:

- The speaker grille is not removable.

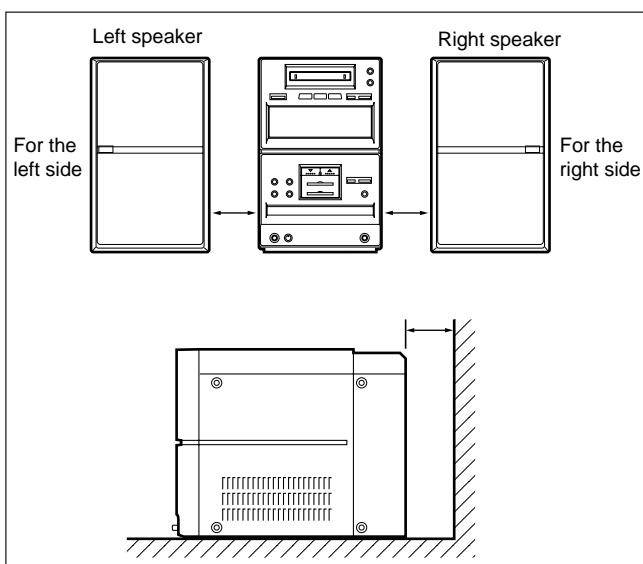
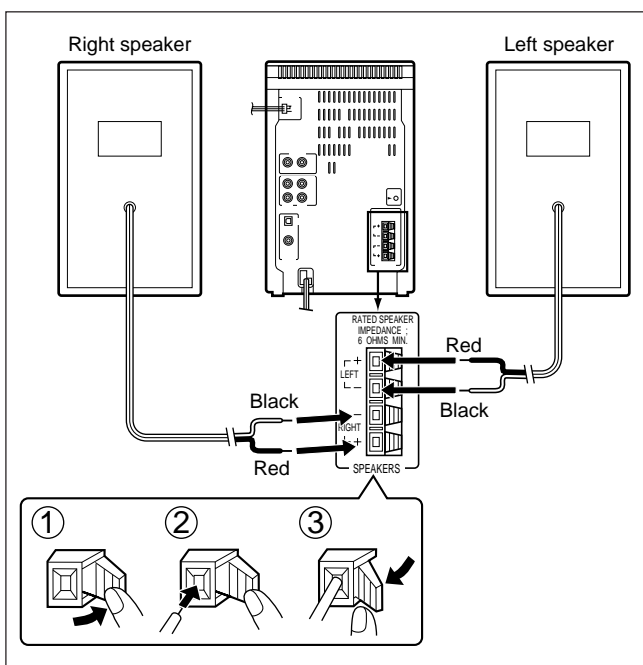

Placing the system

- Be sure to keep space between the units for ventilation.
- Keep the back and sides of this unit at least 2" (5 cm) away from the wall.
- If any kind of magnet or an electromagnet is placed too close to the TV set and the system, irregular color may be seen.

TV set location

- Depending on the particular location of a TV set, color variations may be seen on the TV screen. If this happens, move the system and its speakers away from the TV and turn off the TV set. After 15 - 30 minutes, turn on the TV again.

The TV's own demagnetising function should eliminate the variations. However, if the color still does not look right, move the system further away from the TV set.

Note:

- A cooling fan is built into this product to avoid heat buildup. When the power is turned on, the cooling fan will run.



(Continued)

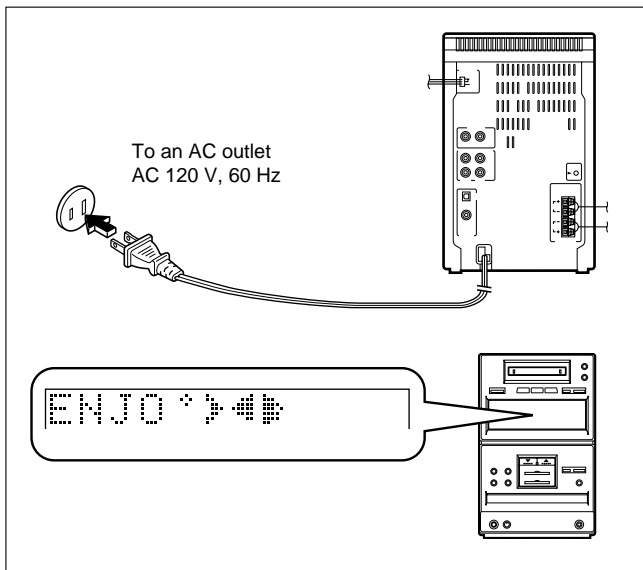

■ Connecting the AC power cord

- After connecting the speakers, plug the AC power cord into a convenient AC outlet.
- Plug the AC power cord into a convenient AC outlet. The letters "ENJOY MUSIC!" will be scrolled across the display.
- Unplug the AC power cord from the AC outlet if the unit is not to be used for a prolonged period of time.

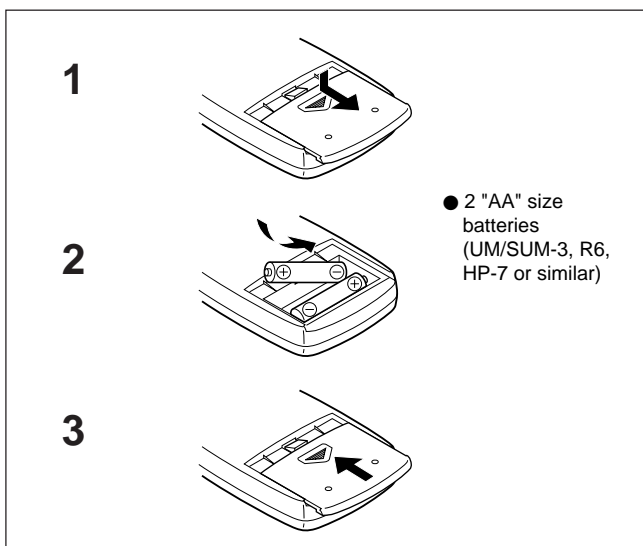

■ Loading the batteries for the remote control

- When inserting or removing the batteries, push them toward the ⊖ battery terminals.
- Installing the batteries incorrectly may cause the unit to malfunction.

Precautions for battery use:

- Insert the batteries according to the direction indicated in the battery compartment.
- Replace all old batteries with new ones at the same time.
- Do not mix old and new batteries.
- Remove the batteries if they are weak or if the unit is not in use for long periods to prevent potential damage due to battery leakage.

Caution:

Do not use rechargeable batteries (nickel-cadmium battery, etc.)

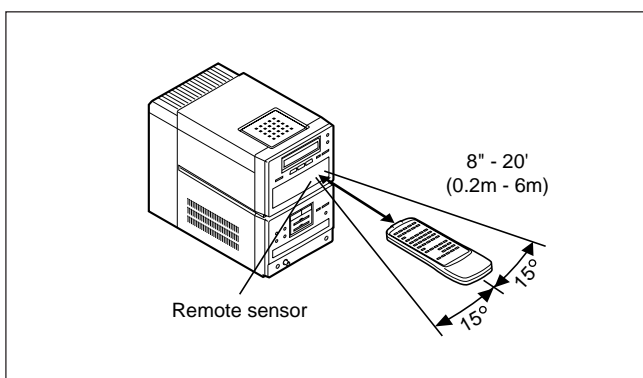

Notes concerning use:

- Replace the batteries if the control distance decreases or operation becomes erratic.
- Periodically clean the transmitter LED on the remote control and the sensor on the main unit with a soft cloth.
- Exposing the sensor on the main unit to strong light may interfere with operation. Change the lighting or the direction of the unit.
- Keep the remote control away from moisture, excessive heat, shock, and vibrations.

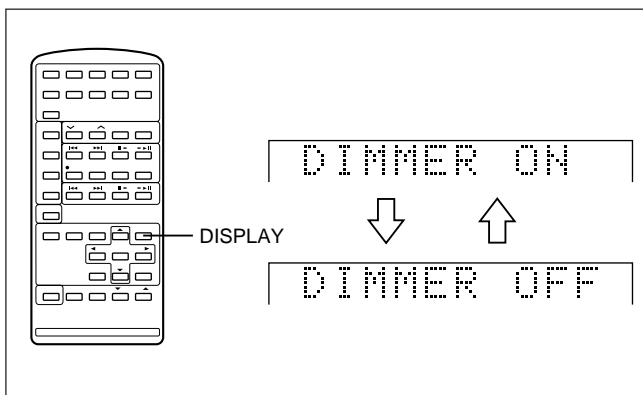

■ To change the brightness of the display

Turn the power on, and keep pressing the DISPLAY button for more than two seconds. The "DIMMER ON" display will appear, and the display will be dimmer.

To return to the original brightness, keep pressing the DISPLAY button for more than two seconds. The "DIMMER OFF" display will appear, and the original brightness is retrieved.





SOUND CONTROL

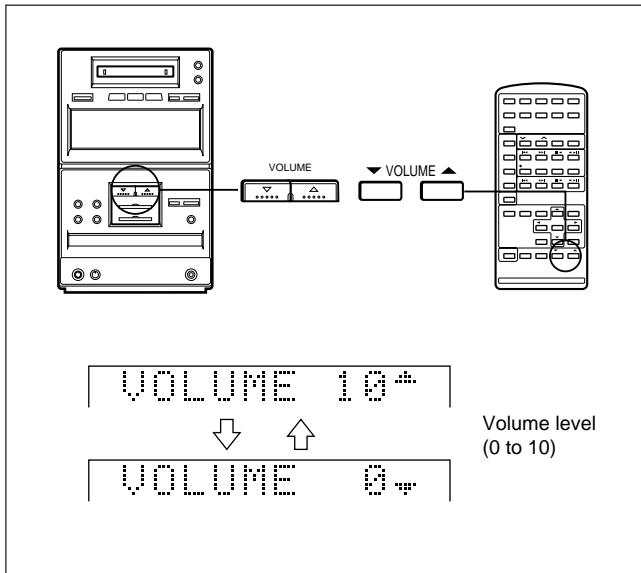

■ Volume

Press the VOLUME Δ button to increase the volume and the VOLUME ∇ button to decrease the volume.

- The volume display can be changed within the range of "0" to "10".

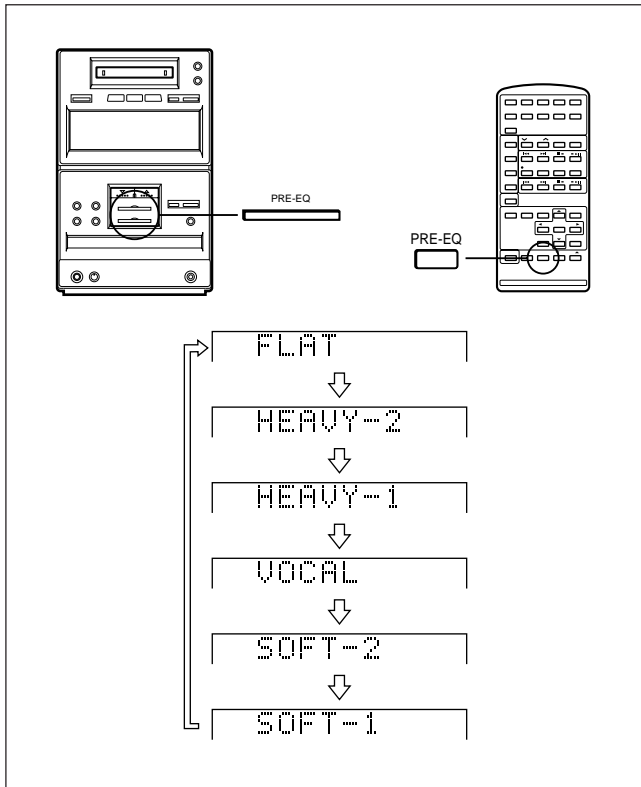

■ Pre-programmed equalizer

When the PRE-EQ button is pressed, the current mode setting will be displayed. To change to a different mode, press the PRE-EQ button repeatedly.

- FLAT: The sound is not modified.
- HEAVY-2: Bass and treble are emphasized a lot.
- HEAVY-1: Bass and treble are slightly emphasized.
- VOCAL: Vocals (midrange tones) are emphasized.
- SOFT-2: Treble is reduced a lot.
- SOFT-1: Treble is cut a little.

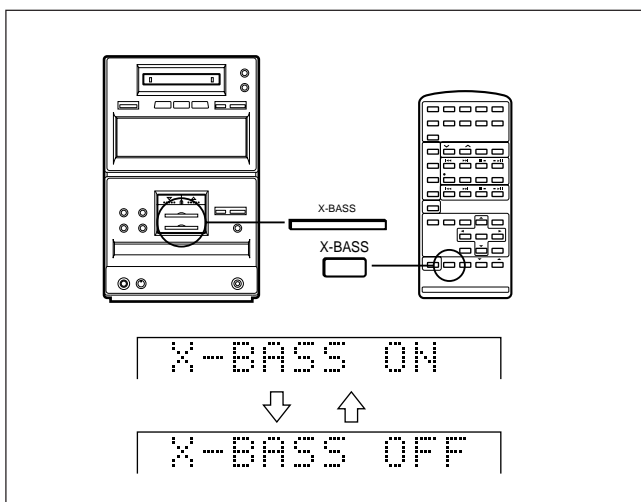

■ Extra bass (X-BASS)

Press the X-BASS button to emphasize the bass region of the frequency spectrum.

"X-BASS ON" will appear.

Press the X-BASS button again to cancel the extra bass mode. "X-BASS OFF" will appear.



SETTING THE CLOCK

The diagram shows the device with three buttons highlighted: POWER, TIMER/DELETE, and ENTER. Below the diagram is a sequence of 14 steps showing the LCD display during the clock setting process:

- 2 | TIMER SET
- 3 | TIME ADJUST
- 4 | DATE 01 '97
CLOCK 12:00 AM
- 5 | DATE 02 '97
- 6 | DATE 09 '97
- 7 | DATE 09 '97
CLOCK 12:30 AM
- 8 | DATE 09 '97
CLOCK 12:30 AM
- 9 | DATE 09 '97
CLOCK 12:30 AM
- 10 | DATE 09 '97
CLOCK 12:00 AM
- 11 | DATE 09 '97
CLOCK 12:00 PM
- 12 | DATE 09 '97
CLOCK 6:00 PM
- 13 | DATE 09 '97
CLOCK 6:28 PM
- 14 | DATE 09 '97
CLOCK 6:28 PM

When you have set the date and time, this unit can be used as a clock. It can be used for timer recording or for timer playback. It is also used to store the MD recording date in memory.

- 1 Press the POWER button to turn the power on.
- 2 Press the TIMER/DELETE button.
- 3 Within 10 seconds, press the ▲ or ▼ button to select "TIME ADJUST".
- 4 Within 10 seconds, press the ENTER button.
 - The unit will enter the date setting mode.
- 5 Adjust the month by pressing the ◀ or ▶ button.
- 6 Press the ENTER button to set the month.
- 7 Adjust the day by pressing the ◀ or ▶ button.
- 8 Press the ENTER button to set the date.
- 9 Adjust the year by pressing the ◀ or ▶ button.
 - Press the button once to increase or decrease the year by one. Keep pressing it to advance continuously.
 - For a year after 2000, set "00" for 2000, "01" for 2001 and so on.
- 10 Press the ENTER button to set the year.
 - The unit will enter the time setting mode.
- 11 Adjust the hour by pressing the ◀ or ▶ button.
 - Press the button once to increase or decrease the hour by one. Keep pressing it to advance continuously.
 - On the display, midnight is shown as "12:00 AM" and noon is shown as "12:00 PM". When setting the time, be careful not to confuse AM and PM.
- 12 Press the ENTER button to set the hour.
- 13 Adjust the minute by pressing the ◀ or ▶ button.
 - Press the button once to increase or decrease the minutes by one. When the button is held down, the time will change in increments of 5 minutes.
- 14 Press the ENTER button to set the minute.
 - The clock will start operating.
 - When about 3 seconds have elapsed, the original display will reappear.

Notes:

- In the event of a power failure or when the AC power cord is disconnected, the clock display will go out. When the AC power supply is restored, the clock display will flash on and off to indicate the time when the power failure occurred or when the AC power cord was disconnected.
- While recording an MD, you cannot set the date and clock. Be sure to set the date and clock before recording.
- The range of dates that can be entered is from January 1, 1997 to December 31, 2049.

To change the setting:

- Once you have set the date and time, "TIME ADJUST" will not be displayed in step 3. Press the ▲ or ▼ button to make the date and time appear.
- If you don't need to change the settings, just press the ENTER button.

To check the date and time:

Press the TIMER/DELETE button, and press the ▲ or ▼ button until the date and time appear.

- When about 10 seconds have elapsed, the original display will reappear.



COMPACT DISC OPERATION

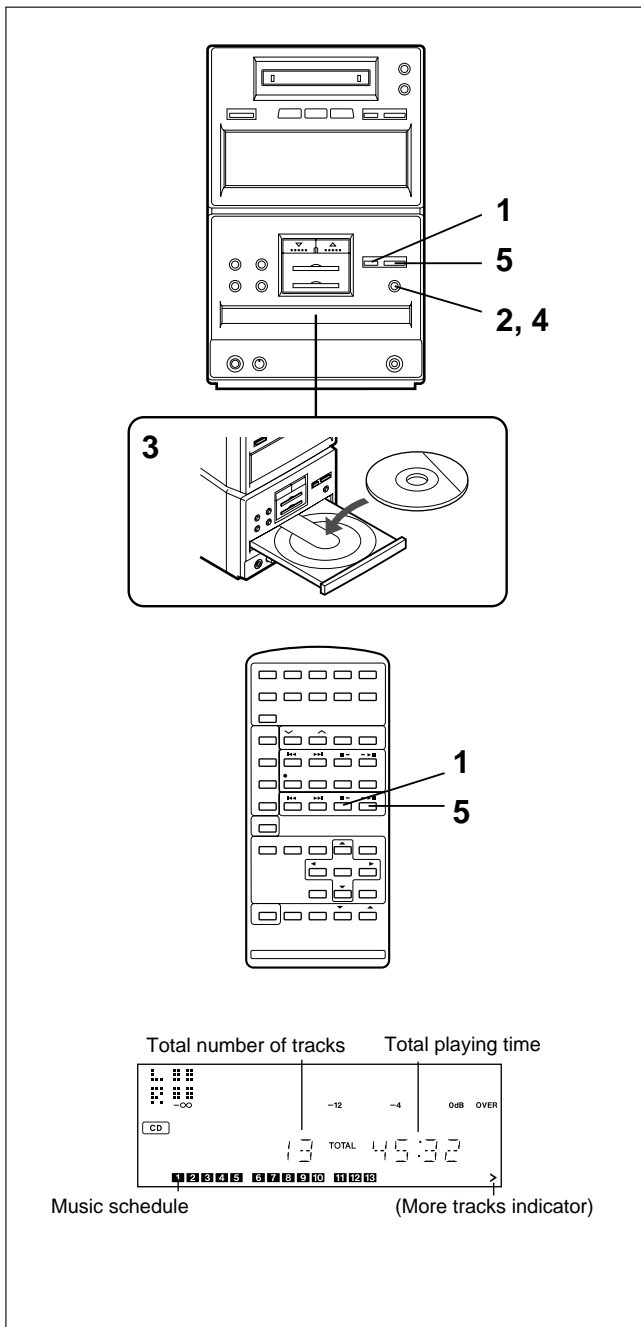

■ Loading and playing CDs

- 1 Press the CD ■ button.
 - The power will be turned on automatically, and the unit will enter the CD playback mode.
 - 2 Press the ▲ button to open the disc tray.
 - 3 Place the CD on the disc tray, label side up.
 - A CD can be placed on any open position on the disc tray.
 - Be sure to place 3" (8 cm) CDs in the middle of the disc holder.
- Caution:**
Do not stack CDs in the tray.
This can damage the player and the CDs.
- 4 Press the ▲ button to close the disc tray.
 - The total number of tracks and the total disc playing time will be displayed.
 - The music schedule will be displayed only for the number of tracks on the disc.
 - If the CD contains more than 21 tracks, ">" will appear.
 - 5 Press the CD ►|| button.
 - Playback will begin from track 1 on the disc you have specified.
 - When all the tracks on the CD have finished playing, the unit will stop automatically.

To interrupt playback:

Press the CD ►|| button.
Press the CD ►|| button to resume playback from the same point.

To stop playback:

Press the CD ■ button.

To remove the CDs:

While in the stop mode, press the ▲ button.

After use:

Press the POWER button to turn the power off.

Direct playback:

If a CD is loaded in the unit, pressing the CD ►|| button turns the power on and begins playback.

Cautions:

- Do not carry the unit with a disc left in the disc tray. The disc may come loose inside the unit and be damaged or cause damage to the unit. This may also cause malfunctions.
- Do not place two CDs in the disc tray.
- Do not push the disc tray while it is moving.
- If the power fails while the drawer is open, wait until the power is restored before trying to close it.
- If the disc drawer is stopped forcibly, "ERROR" will appear on the display and the unit will not function.
If this occurs, turn the power off, and turn it on again.
- If TV or radio interference occurs during CD operation, move the unit away from the TV or radio.
- If the main unit is subjected to a sharp jolt or it is used where vibrations are present, sound dropouts may occur. Use the unit in a stable environment.
If the volume is set to too high, a dropout may occur due to vibrations from the speakers. If this happens, move the main unit away from the speakers or turn down the volume.
- Do not use CDs with loose cellophane tape or stickers or CDs which have glue left on the surface from tape or stickers. If such a CD is inserted, you may not be able to remove the CD or the unit may malfunction.



MINIDISC OPERATION

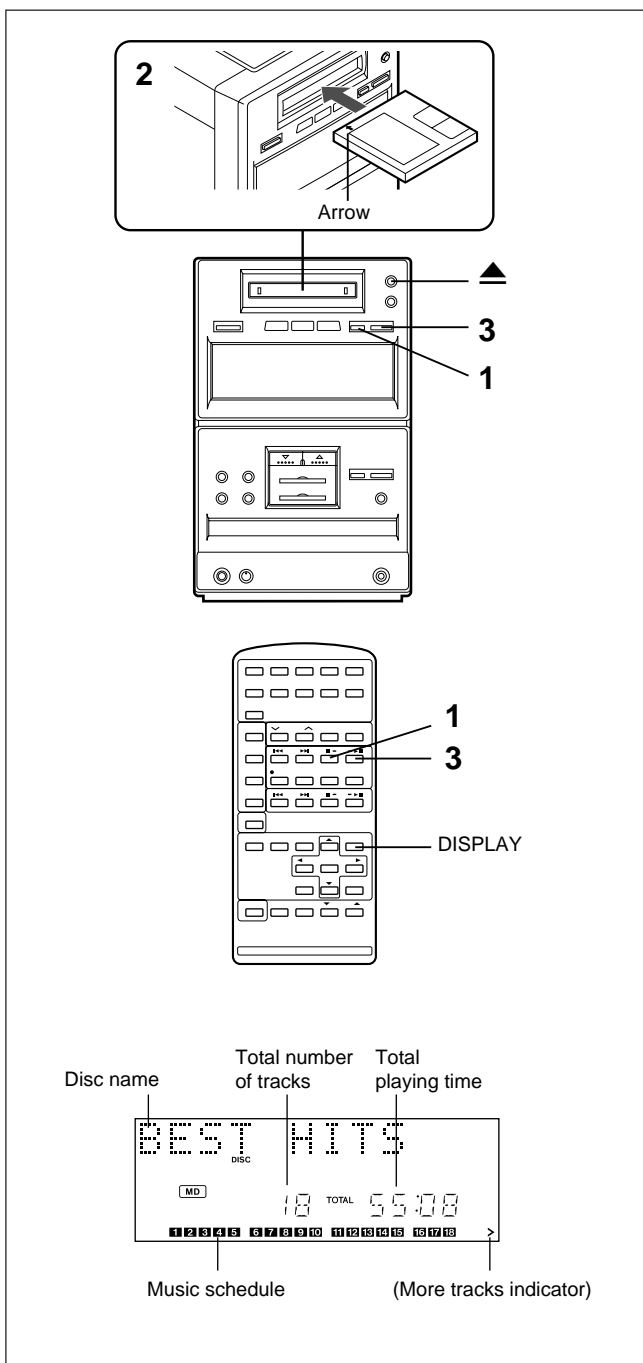

■ Loading and playing MiniDiscs

- 1 Press the MD ■ button.
 - The power will be turned on automatically, and the unit will enter the MD playback mode.
- 2 Load a recorded MiniDisc in the direction indicated by the arrow on the MiniDisc, with the labeled side facing up.
 - The total number of tracks and the total disc playing time will be displayed.
 - The music schedule will be displayed only for the number of tracks on the disc.
 - If the MD contains more than 21 tracks, ">" will appear.
 - If an untitled MD is inserted, no disc name will be displayed.
- 3 Press the MD ►|| button.
 - Playback will begin from track 1 on the disc you have specified.
 - If the disc has track names, the track names will be scrolled across the display.
 - When the last track has been played back, this unit will stop automatically.

To interrupt playback:

Press the MD ►|| button.
Press the MD ►|| button to resume playback from the same point.

To stop playback

Press the MD ■ button.

To remove a MiniDisc:

Press the ▲ button.
● The MiniDisc will be ejected.

Notes:

- Although vibration will not normally cause a MiniDisc to skip, you may hear a skip in the sound if there is continuous vibration.
- When you listen to MiniDiscs near a radio or a TV set, the radio or the TV set may pick up noise.
Keep the unit as far away as possible from tuners.

After use:

Press the POWER button to turn the power off.

Note

- The power cannot be turned off while the unit is reading the information on a MiniDisc.

Direct playback:

If a MiniDisc is loaded in the unit, pressing the MD ►|| button turns the power on, and begins playback.

To check a track name or the date of a recording during playback:

- Press the DISPLAY button on the remote control during playback.
- Each time this button is pressed, the display will switch.
 - In the following cases, disc names, track names and recording dates will not be displayed:
 - A MiniDisc that has not been given a disc name or track name
 - A MiniDisc that does not have a recording date on it

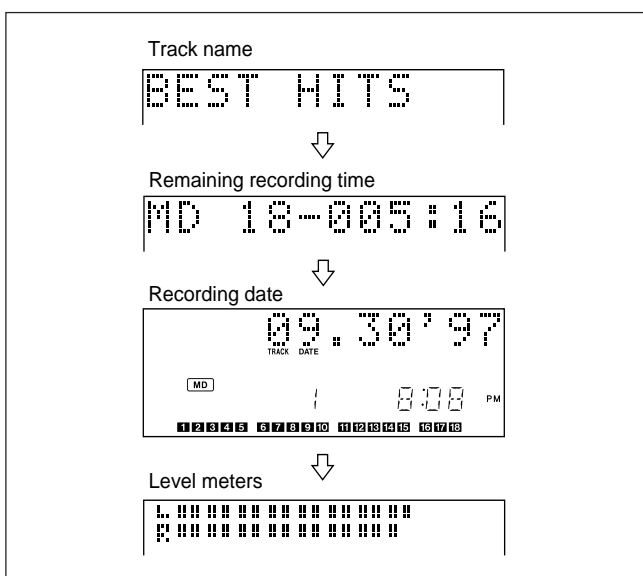



RADIO OPERATION

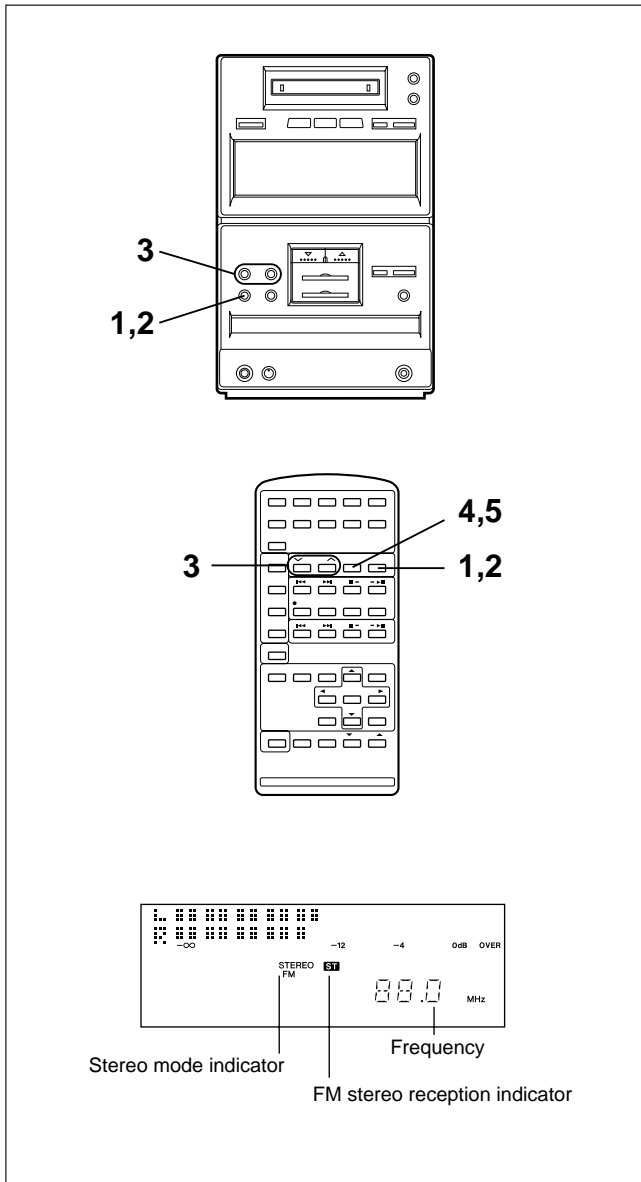

■ Tuning

- 1 Press the TUNER (BAND) button.
 - The power is turned on, and the tuner is selected.
- 2 Press the TUNER (BAND) button to select the desired frequency band (FM or AM).
- 3 Tune in to the desired station using the TUNING ∇ or \wedge button.

Auto tuning:

When the TUNING ∇ or \wedge button is pressed for more than 0.5 seconds and then released, the tuning stops at the first receivable broadcast station.

Notes:

- When radio interference occurs during auto tuning, auto tuning may stop automatically at that point.
- If a weak station signal is found during auto tuning, the station will be skipped.
- To stop auto tuning, press the TUNING ∇ or \wedge button again.

Manual tuning:

Press the TUNING ∇ or \wedge button as many times as necessary to adjust the frequency display to the frequency of the desired station.

- 4 To receive FM stereo, press the ST-MODE button on the remote control so that the "STEREO" indicator appears.
 - "ST" will appear when an FM broadcast is in stereo.
- 5 If the FM stereo reception is weak, press the ST-MODE button so that the "STEREO" indicator goes out.
 - Although the reception changes to monaural, the sound becomes clearer.

After use:

Press the POWER button to turn the power off.

Direct playback:

Just pressing the TUNER (BAND) button will turn on the power automatically. The radio station you were listening to last will be tuned in.

Notes:

- The memory recalls the last station received even after changing the TUNER (BAND) button or function selector buttons, or pressing the POWER button to turn the power off.
- If you are listening to the radio near personal computers, radios, or TV sets, various noise or interference may be heard. Keep this unit as far away as possible from these products.



(Continued)

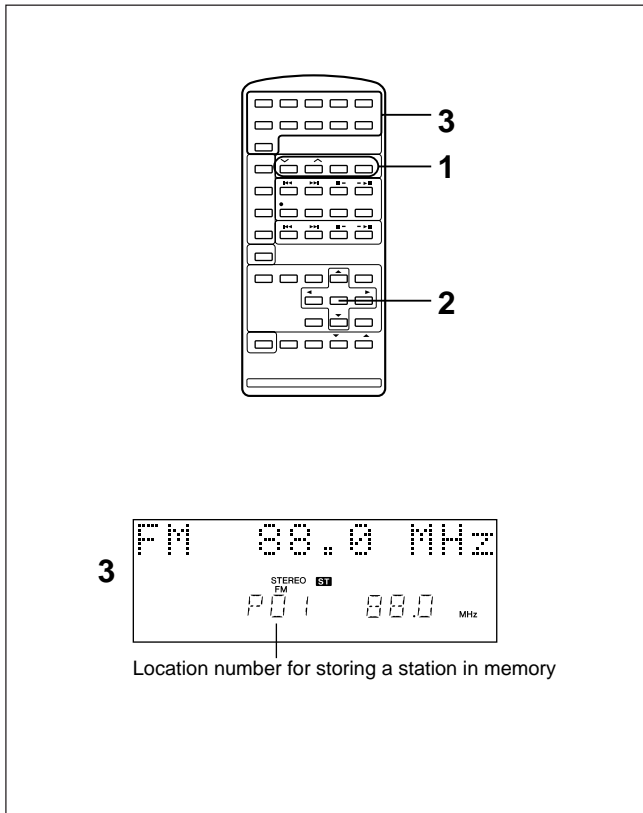

■ Preset tuning

You can store up to 40 stations in memory (40 stations consisting of any combination of FM and AM stations you like) and recall them together with their FM reception mode (stereo or mono), at the push of a button.

- 1 Perform steps 1 - 5 in the "Tuning" section.
- 2 Press the ENTER button.
- 3 Within 10 seconds, press the tuner preset number buttons.
- 4 Repeat steps 1 - 3 to set other preset stations, or to change a preset station.

- When a new station is stored in a preset number location, the previous contents of that location will be erased.

To select preset numbers 11 to 40.

Press the >10 button first, then press the preset number.

For example to select 35:

- 1 Press the >10 button.
- 2 Within 5 seconds, press the "3" button.
- 3 Within 5 seconds, press the "5" button.

Note:

- After a prolonged power failure, the contents of the memory will be lost. When power is restored, enter your selections in memory again. (For power failures of just a few hours or less, the contents of the memory will not be lost.)

■ To recall a preset station

- 1 Press the TUNER (BAND) button.
- 2 Press the tuner preset number button to recall the preset channel.
- The frequency will appear on the display.

Note:

- You can create names for radio stations that have been stored in memory. (Page 27)





CD AND MD OPERATIONS

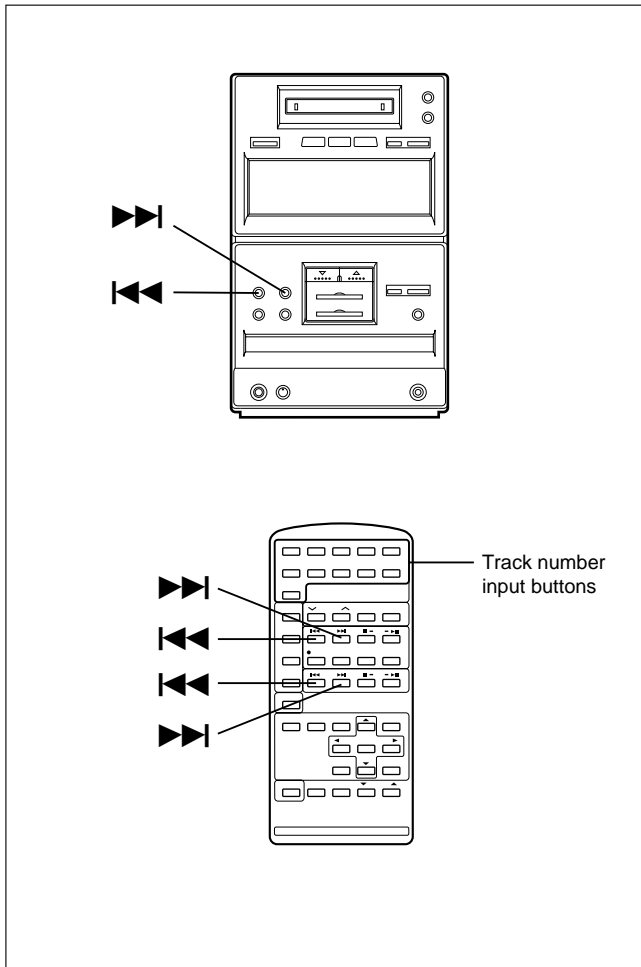

■ Direct-selection play

By using the track number input buttons on the remote control, any track you wish to can be played directly, by entering its number.

- 1 Select the desired program source, CD or MD, by pressing the CD ■ or MD ■ button.
- 2 Use the track number input buttons to select the desired track number.

A. To select track numbers 11 to 99

Press the >10 button first, then press the track number.
For example to select 28:

- 1 Press the >10 button.
- 2 Within 5 seconds, press the "2" button.
- 3 Within 5 seconds, press the "8" button.

B. To select track number 100 or higher (only for MD)

Press the >10 button twice, then press the track number.
For example to select 105:

- 1 Press the >10 button.
- 2 Within 5 seconds, press the >10 button.
- 3 Within 5 seconds, press the "1" button.
- 4 Within 5 seconds, press the "10/0" button.
- 5 Within 5 seconds, press the "5" button.

The beginning of the selected track will be found, and play will begin automatically.

Notes:

- A track number higher than the number of tracks on the disc cannot be selected.
- During APMS play or random play, track number selection play is not possible.

■ Cue and review

- 1 Load a disc and begin playback.
- 2 Hold down the ►► button for audible fast forward, and hold down the ◀◀ button for audible fast reverse.
- 3 Normal playback will resume when the ►► or ◀◀ button is released.

Notes:

- If the end of the disc is reached while cueing, "DISC END" will appear on the display, and operation will pause. Press the CD ■ or MD ■ button to stop operation. When you want to listen to the disc again, press the ◀◀ button to locate the desired track. Normal playback will start from that point.
- When the beginning of the first track is reached, normal playback will start.

To search very quickly

When fast forward or fast reverse is used while in the pause mode, the playback point will move more quickly than when using audible fast forward or audible fast reverse in the playback mode.

- In this mode, no sound is heard. Therefore, you must refer to the time display.
- When you lift your finger, the unit will re-enter the pause mode.

■ APSS (Auto Program Search System)

APSS automatically locates the beginning of any track.

To listen again to the track being played:

Press the ◀◀ button for less than 0.5 seconds during playback.

To move to the beginning of the next track:

Press the ►► button for less than 0.5 seconds during playback.

- To skip a number of tracks at one time, press the ◀◀ or ►► button repeatedly until the desired track number is shown.
- To start playback from a desired track, press the ◀◀ or ►► button while in the stop mode to select the track number, and then press the ►► button.

(Continued)

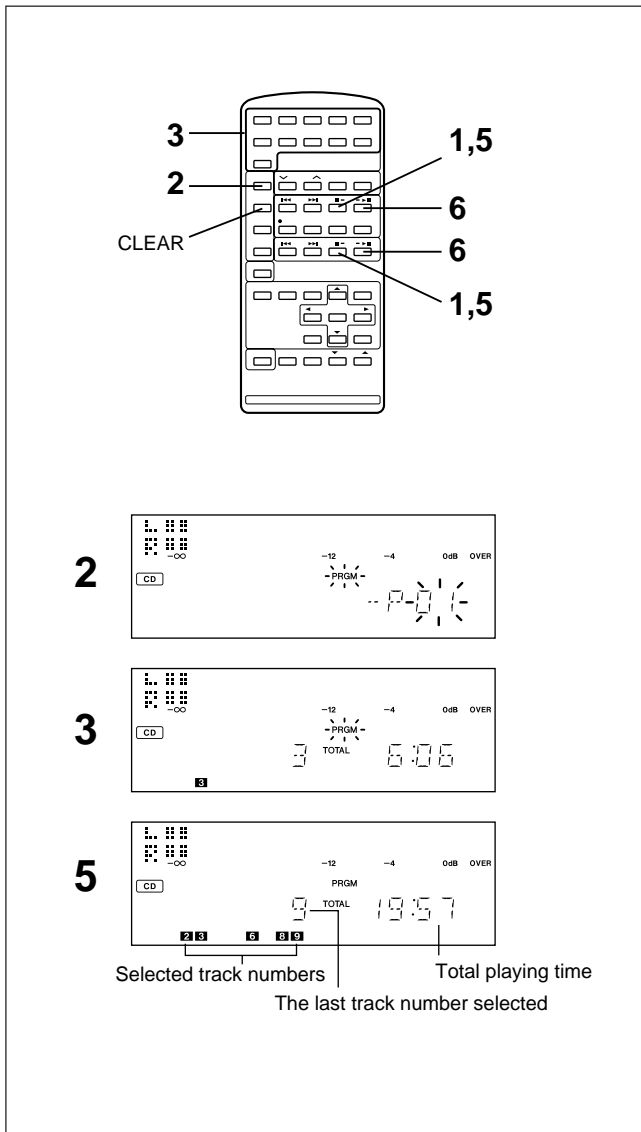

■ APMS

(Automatic Programmable Music Selector)

- 1 Select the desired program source, CD or MD, by pressing the CD ■ or MD ■ button.
- 2 Press the PROGRAM button.
 - "PRGM" will flash.
- 3 Use the track number input buttons to designate the desired track number.
- 4 Repeat step 3 for any other tracks. Up to 20 tracks for MD or 32 tracks for CD can be programmed.
 - The programmed playback order and the total playing time of the programmed tracks will be automatically displayed, and only those track numbers will appear in the music schedule.
 - If the total playing time of the programmed tracks exceeds 199 minutes 59 seconds, "--:--" will be displayed. In this case, the programmed tracks are stored.
- 5 Press the CD ■ or MD ■ button.
- 6 Press the CD ►|| or MD ►|| button to start playback of the programmed selections.
 - After all of the programmed tracks have finished playback, the unit will automatically stop.

To add tracks to the APMS:

When a program has been entered ("PRGM" is flashing), perform step 3. Additional tracks can be selected, and they will be stored after the last track you entered.

To clear the programmed selections:

Press the CLEAR button while "PRGM" is flashing.

- Each time the button is pressed, one track will be cleared, beginning with the last track programmed.

To cancel the APMS:

While the unit is stopped in the APMS mode, press the CLEAR button.

- The program contents will be erased.
- When you open the disc tray or a MiniDisc is removed, the APMS mode will be canceled.

To check which tracks are programmed:

While the unit is stopped in the APMS mode, press the ◀◀ or ▶▶ button.

Notes:

- It is not possible to insert an additional track between programmed tracks that have already been entered.
- Programming and canceling are not possible during playback or in the pause mode.

You can make program selections from CDs with the main unit.

- 1 Press the CD ■ button.
- 2 Hold down the TRACK button for at least 2 seconds.
- 3 Press the ◀◀ or ▶▶ button to select the track you want to listen to.
- 4 Press the TRACK button.
- 5 Repeat steps 3 and 4 for any other tracks.
- 6 Press the CD ■ button.



(Continued)

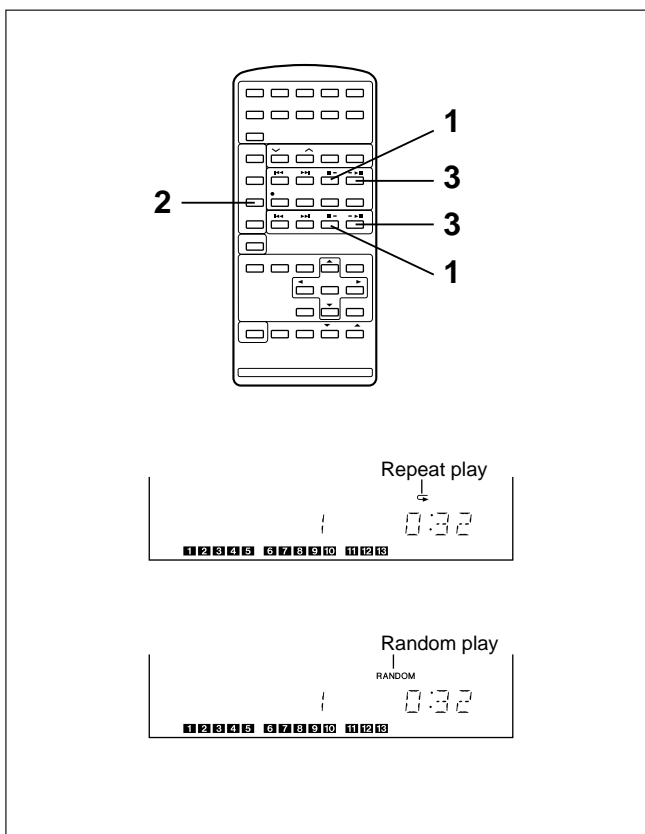

■ Random and repeat play

- 1 Select the desired program source, CD or MD, by pressing the CD ■ or MD ■ button.
- 2 Press the P-MODE button.
 - Each time this button is pressed, the mode will change in the following order:
Repeat play → Random play → Normal play
- 3 Press the ►|| button to start playback.
 - Repeat play
Play will continue until it is stopped.
 - Random play
Play will stop after all the tracks have been played once. (The same track will not be played twice.)

To stop playback:

Press the CD ■ or MD ■ button.

To cancel repeat playback or random play:

Press the P-MODE button until the ◻ or "RANDOM" display disappears.

To repeat playback of selected tracks:

Enter the program for the tracks you want and start repeat play. You can program a single track and play it repeatedly.

Notes:

- During APMS play, random play is not possible.
- Repeat play will continue until you stop it. Therefore, do not forget to cancel repeat play.

■ Switching the time display

Each time the TIME button is pressed during playback or pause, the display will change as described below.

See the diagram to the left.

- 1 The elapsed play time for each track will be displayed.
- 2 The remaining play time for the current track will be displayed.
- 3 The total remaining play time for the disc from the point being played at that time will be displayed.

Notes:

- During random play, the total remaining play time displayed for the disc will be from the point being played at that time. The display cannot be switched.
- Depending on a CD or MD to be played, the play time display may not match the play time indicated on the CD or MD jacket, because the time between the tracks is not included.

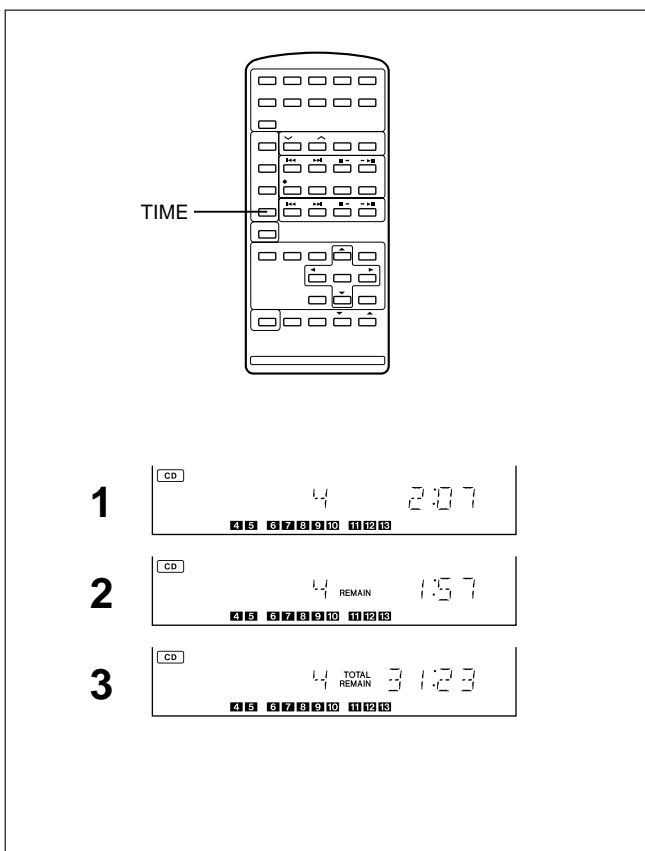



BASIC INFORMATION ON MINIDISCS

Differences from tape recordings

You cannot record music on the back side of a MiniDisc.

MiniDiscs cannot be inserted when they are turned over. (Page 37)

You don't need to search for the starting point at which to record.

The unit automatically finds the point at which recording can start. Recording will start from that point.

You can check the total or remaining recordable time (possible recording) before recording.

This lets you plan a recording session so that the last song will not come to an abrupt end before it has finished. (Page 17)

The date and time of a recording are automatically saved with the recording.

If you have set the date and time, they will be automatically recorded when a recording is made. (page 8)

Information (TOC) to be recorded on an MD

The TOC (Table of Contents) is information on track numbers and recording areas to allow the unit to recognize musical selections or sounds.

The entire MD is controlled depending on this TOC, which enables the unit to find the beginning of a track quickly or to automatically record in a vacant area.

- The TOC is recorded in a specific area on a MiniDisc, which is not used for sound recording.

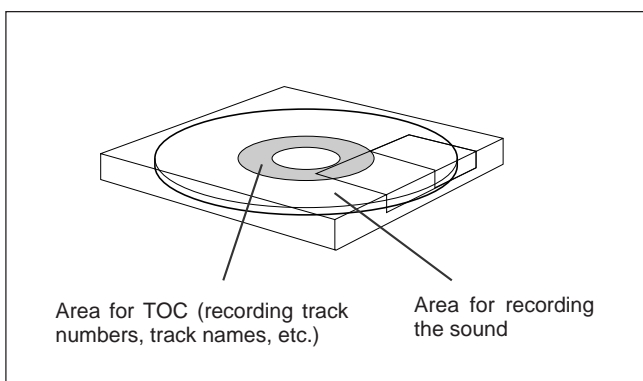

When you start recording or editing, "TOC" will appear in the display window.

This indicates that information in the TOC is now being changed according to recording or editing being performed. (The changed TOC is not yet recorded on the MiniDisc at this time.)

The TOC is recorded when

- you stop recording.
- you switch to another input source.
- you eject the MiniDisc.
- you turn the power off.

Do NOT unplug the power cord while the TOC is being recorded ("TOC" is flashing). Also, do not subject the unit to any shocks or sharp jolts. Otherwise the TOC will not be correctly recorded, and consequently proper playback may not be possible.

Note about making digital copies

MiniDiscs are designed so that further copies cannot be made from digitally recorded MiniDisc tracks. This is a specification of the SCMS (Serial Copy Management System).

About track numbers

When you make a recording on a MiniDisc, track numbers are created automatically.

When recording from CDs inserted in this unit or making a digital recording from an external unit (CD or MD)

New track numbers will be created automatically according to the original tracks (Synchro mark function).

- When you record from a CD to a MiniDisc, the track numbers recorded on the MiniDisc may not match the track numbers on the CD.

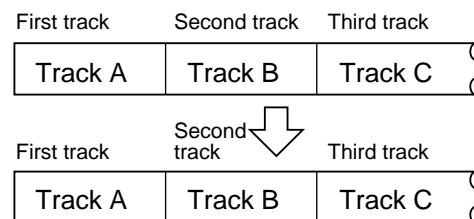

When recording from this unit's radio

One continuous recording is regarded as a single track.

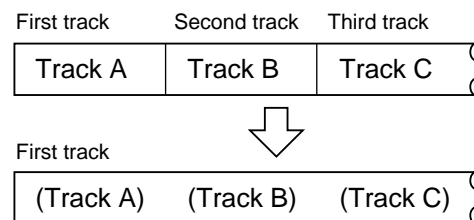

When recording from external analog equipment

If there is 1.5 seconds or more of silence, the blank space is assumed to be the space between tracks, and a new track number is created automatically (Auto mark function).

- If the signal to be recorded contains some noise, the track numbers may not be properly created.
- You can also record musical selections as a single track without using the Auto mark function.

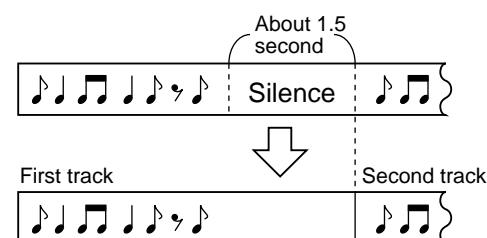

Note:

- When external units such as a DSS tuner or a DAT are connected and a recording is made, the Auto mark function will work.





RECORDING

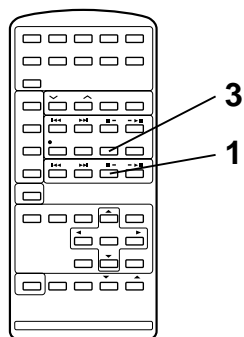
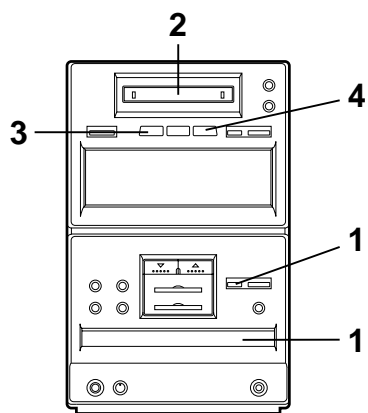

If recording does not begin:

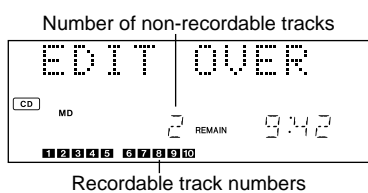
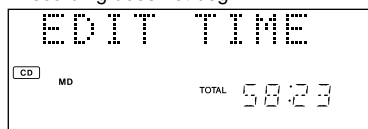

■ Recording from a CD onto a MiniDisc (One-Touch Editing)

- 1 Press the CD button, and load the compact disc.
- 2 Load a recordable MiniDisc.
- 3 Check the record mode by pressing the REC MODE button.
- 4 Press the CD ► MD button.
 - Playback of the first track and recording begin.
 - When the disc is completely recorded, recording automatically stops.

If recording does not begin:

When not all of the tracks on a CD can be recorded, the unit will enter the recording stand-by mode. To record on only those tracks which can be recorded, press the CD ► MD button.

To cancel operation:

Before pressing the CD ► MD button, press the CD button or MD button.

To stop recording:

Press the CD button. After recording the track number, playback and recording will stop. It is not possible to pause recording.

Note:

- You can program a series of tracks and record them. (Page 14)

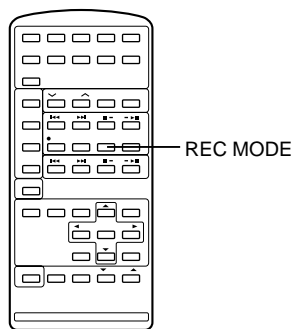

Stereo mode



Monaural long-play mode

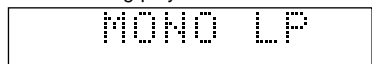

■ About monaural long-play mode

When a recording is made in the monaural long-play mode, the length of the recording can be double that of a stereo recording for the same amount of space on the MD. The monaural long-play mode is very useful for recording songs that were originally recorded in monaural, or for recording talk programs.

Press the REC MODE button.

- Each time the button is pressed, the display will switch between the stereo mode and the monaural long-play mode.
- This mode cannot be changed while recording.
- The level meter shows stereo indication even when the mode is the monaural long-play mode.
- The recording mode will not change back until you change it manually. After you have made a recording in the monaural long-play mode, it is recommended that you return the unit to the stereo mode so that you won't forget to do so later.



(Continued)

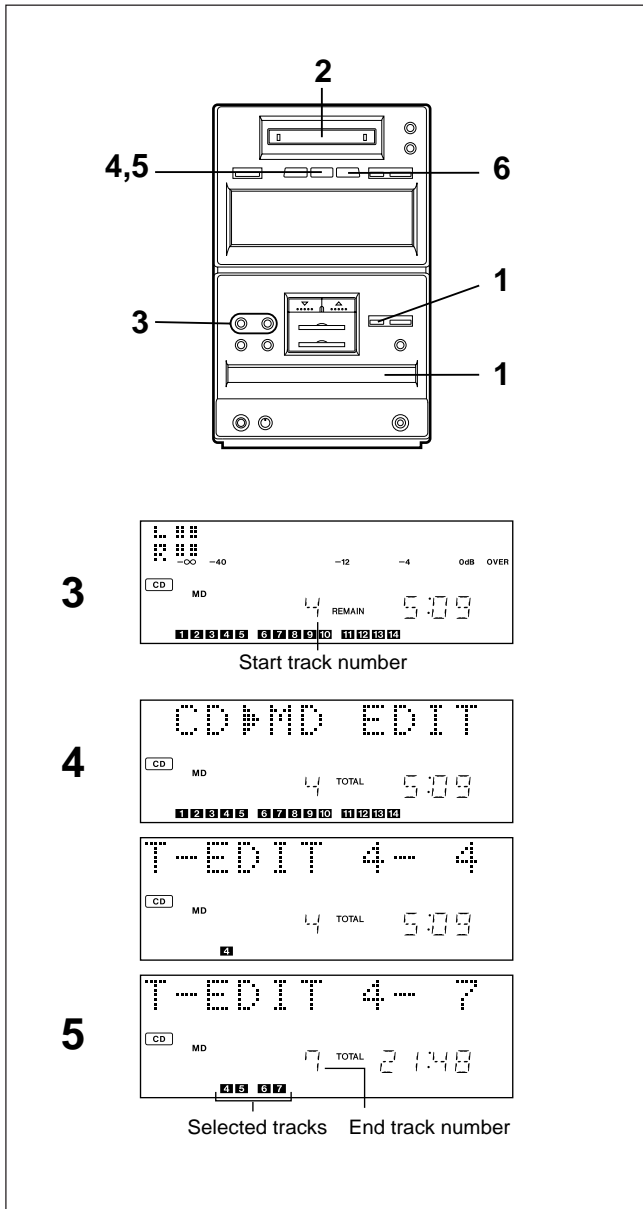

■ Recording desired tracks from a CD onto a MiniDisc (Track Editing)

You can record one track or a series of several tracks from a CD onto an MD. You can select one track and record it. (If the track numbers are not in succession, you cannot select a series of tracks.)

- 1 Press the CD ■ button, and load a compact disc.
- 2 Load a recordable MiniDisc.
- 3 Select the track to start recording by the ◀◀ or ▶▶ button.
 - The selected track number appears.
- 4 Press the TRACK button.
 - To record a single track, skip to step 6.
- 5 Select the track to end recording by pressing the TRACK button.
- 6 Press the CD ► MD button.
 - When all tracks are recorded, recording automatically stops.

If recording does not begin:

When not all of the tracks on a CD can be recorded, the unit will enter the recording stand-by mode. To record on only those tracks which can be recorded, press the CD ► MD button.

To cancel operation:

Before pressing the CD ► MD button, press the CD ■ or MD ■ button.

To stop recording:

Press the CD ■ button. After recording the track number, playback and recording will stop. It is not possible to pause recording.

To rerecord:

If you wish to rerecord, you can erase a track that is already recorded, starting from any point in the old track, to begin a new recording. Be aware that when you do this, all of the tracks and track names that follow the newly recorded track will be erased.

- 1 During playback, press the MD ►|| button at the point where you wish to begin rerecording.
 - The unit will pause.
- 2 Press the ● REC button.
 - The "R.ERASE OK?" display will appear.
- 3 Press the ENTER button.
 - The unit will enter the recording stand-by mode.
- 4 Select the recording source and start recording.



(Continued)

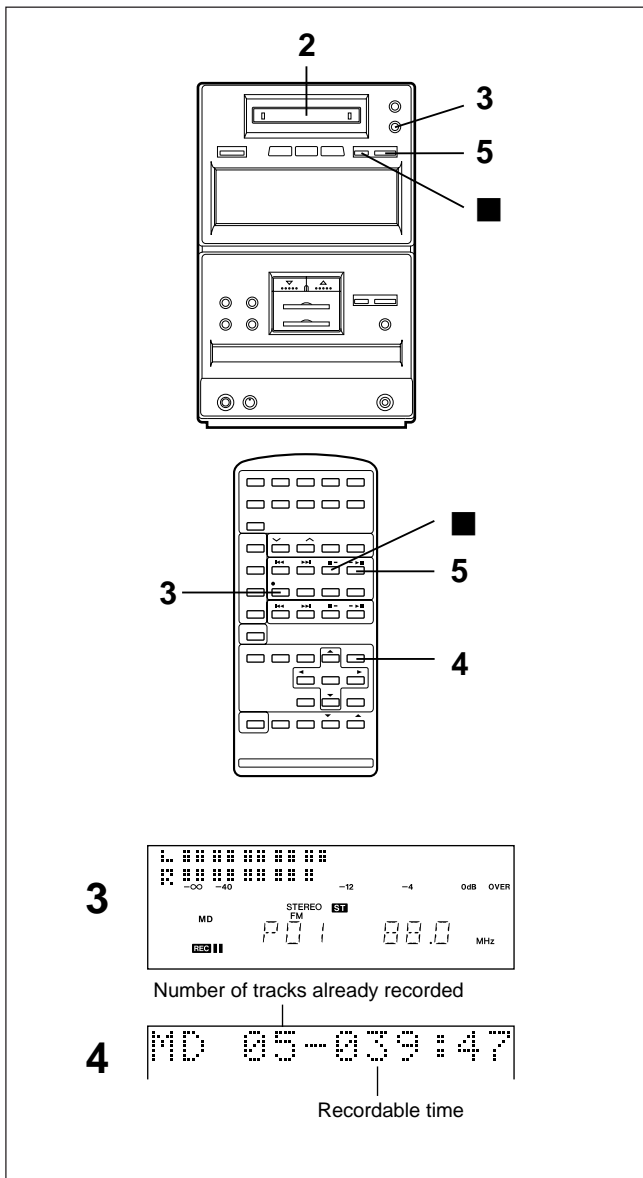

■ Recording from the built-in radio onto a MiniDisc

- 1 Tune in the radio station to be recorded.
- 2 Load a recordable MiniDisc.
- 3 Press the ● REC button.
 - The unit will enter the recording stand-by mode.
 - Automatic tuning is impossible while in the recording stand-by mode.
- 4 Check the recordable time by pressing the DISPLAY button on the remote control.
- 5 Press the MD ►|| button.
 - During recording, you cannot change the station.

Note:

- When recording from the AM band, put the unit in the recording stand-by mode. Then, before recording, separate the AM loop antenna from the main unit, and adjust the radio reception so that the AM station is tuned in clearly.

To interrupt recording:

Press the MD ►|| button during recording.
Press the MD ►|| button again to resume recording.
The track number increases.

To record the track number during recording:

Press the ● REC button.

To stop recording:

Press the MD ■ button.
After recording the track number, recording stops.

Notes:

- The contents of a single recording are recorded under a single track number as a series of tracks.
- If you use the monaural extended recording mode, you can make recordings that are about twice as long as stereo recordings. This is convenient for recording monaural broadcasts or talk programs. (Page 17)



EDITING

We will explain the 5 editing functions you can use to create your own recorded MiniDiscs.

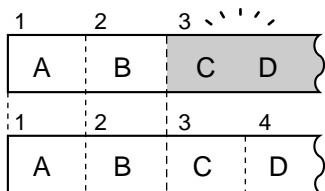

Divide

A track can be divided into two tracks. If two selections were recorded as a single track because there was not enough silent space between the tracks, you can use the DIVIDE function to separate the selections. This feature is also convenient for identifying specific points with one selection so that you can locate those points easily whenever you like. (Page 22)

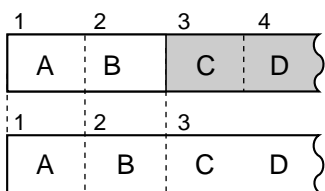

Combine

Two adjacent tracks (for example, the third and fourth tracks) can be combined. If there is a prolonged silence in the middle of a selection that is recorded, a single piece of music may be recorded as two tracks. If this happens, these two tracks can be combined into a single track. (Page 22)

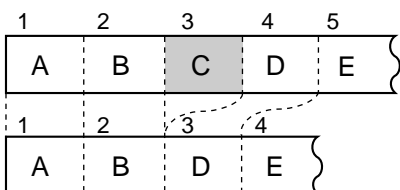

Erase

Tracks you want to erase can be erased one at a time or all at once. Once a track has been erased, it cannot be recovered. Double-check the track number before erasing it. (Page 24)

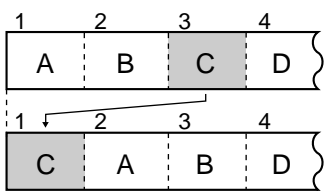

Move

The order of the recorded tracks can be changed. This feature is different from program play. A new track order can be recorded directly on the disc. When the power is turned off, the revised order will not be changed. (Page 23)

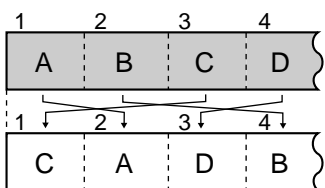

Programmed move function

This function allows the track numbers to be automatically rearranged in the order specified for programmed playback. The track numbers will be adjusted as needed, automatically. (The tracks that are not included in the programmed selections will be put at the end of the new track numbers.) (Page 23)



Track/Disc name

You can assign titles to recorded tracks and to discs. The characters must be capital and lowercase letters, or symbols. Track and disc names can use up to 100 characters per name. (Page 25)

Note:

- When a program has been entered, the following operations cannot be done. You must cancel the program to perform these operations. (Page 14)
- Divide
- Combine
- Erase
- Move
- Track/disc name





(Continued)

Using the editing function

We will show you some examples of how to use the editing functions. You can create a disc of your favorite selections by recording tracks from a variety of input sources such as CDs and radio broadcasts.

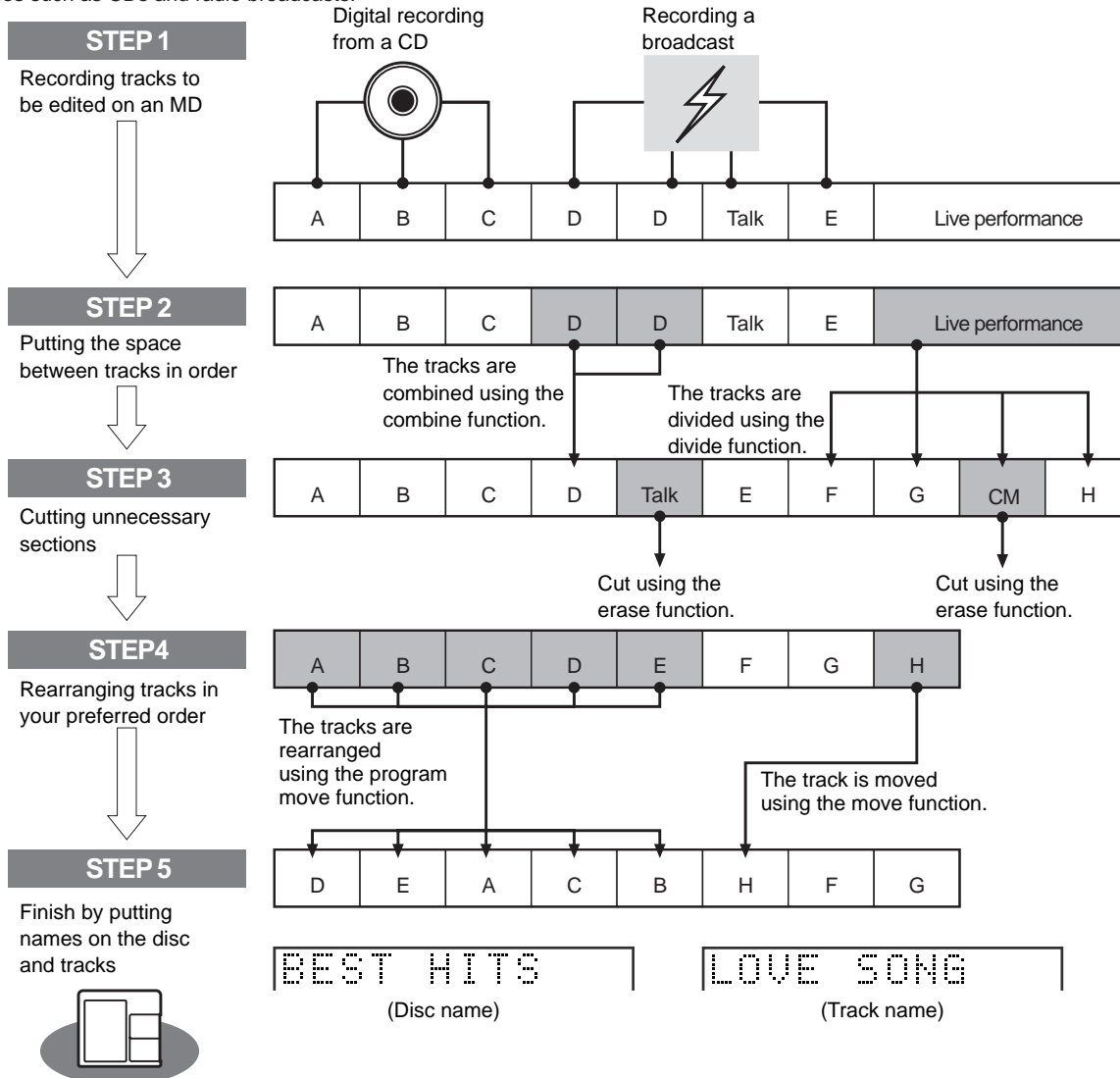

Edit Menu

The editing functions are selected from the edit menu. The functions which can be selected from the edit menu will vary, depending on the state which an editing operation is started.

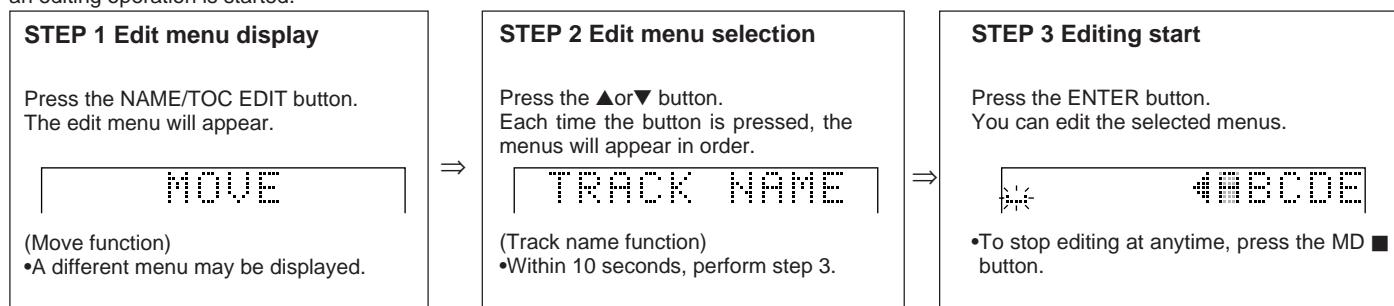

Recording the editing results

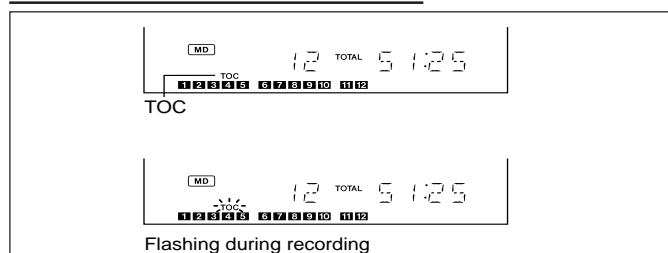

While editing, the "TOC" indicator is displayed. This means the edit results have not been recorded on the MiniDisc.

To record the results, select another input or turn the power off. During writing, the "TOC" display will flash.

Once the "TOC" goes out, all editing has been recorded to the disc.

Note:

- Storing the edited contents on the disc can be done after several pieces of editing have been finished.





(Continued)

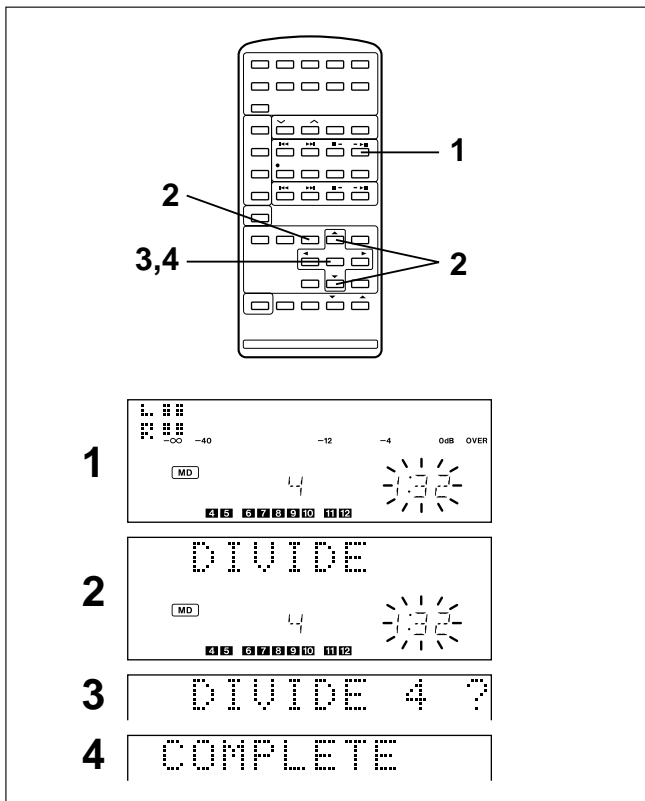

Divide

- 1 Play the track which you wish to divide into two and press the MD ►|| button at the point where you wish to divide the track.
 - The unit will enter the pause mode.
- 2 Press the NAME/TOC EDIT button, and then select "DIVIDE" using the ▲ or ▼ button.
- 3 Within 10 seconds, press the ENTER button.
 - To cancel the operation, press the MD ■ button.
- 4 Press the ENTER button again.
 - The tracks are divided, and the unit is stopped at the beginning of the second of the two tracks.
 - The numbers of the tracks which come after the divided track are automatically increased by one.

Note:

- When a track which has been given a name is divided, the two new tracks will have the same name and date. If the "TOC FULL" message is displayed, the second track may not be given a name.

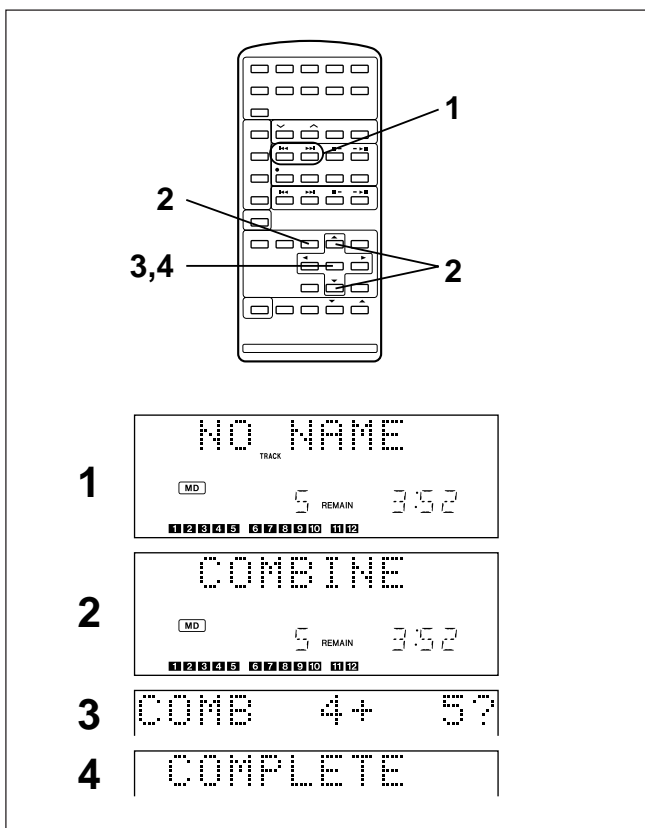

Combine

- 1 While in the stop mode, select the second of the two tracks you wish to combine using the ◀◀ or ▶▶ button.
 - Start playing the second of the two tracks you wish to combine, and then press the MD ►|| button.
- 2 Press the NAME/TOC EDIT button, and then select "COMBINE" using the ▲ or ▼ button..
- 3 Within 10 seconds, press the ENTER button.
 - To cancel the operation, press the MD ■ button.
- 4 Press the ENTER button again.
 - The two tracks are combined, and the unit is stopped at the beginning of the combined track.
 - The numbers assigned to the tracks following the combined track are automatically decreased by one.

When both tracks have a name:

- When only the first track has a name → That name will be used.
- When only the second of the two tracks has a name → That name will be used.
- When both tracks have a name → The name of the first track will be used.

To combine two noncontiguous tracks:

(Example: the first and third tracks)
 Move the third track to the second track using the MOVE function.
 (Page 23)
 Then, combine the first and second tracks using the COMBINE function.

Notes:

- Tracks recorded from analog inputs cannot be combined with tracks recorded from CDs or MDs using the digital inputs.
- Tracks recorded in the stereo mode cannot be combined with tracks recorded in the monaural long-play mode.
- Tracks where either track's recording time is less than 15 seconds may not be combined.



(Continued)

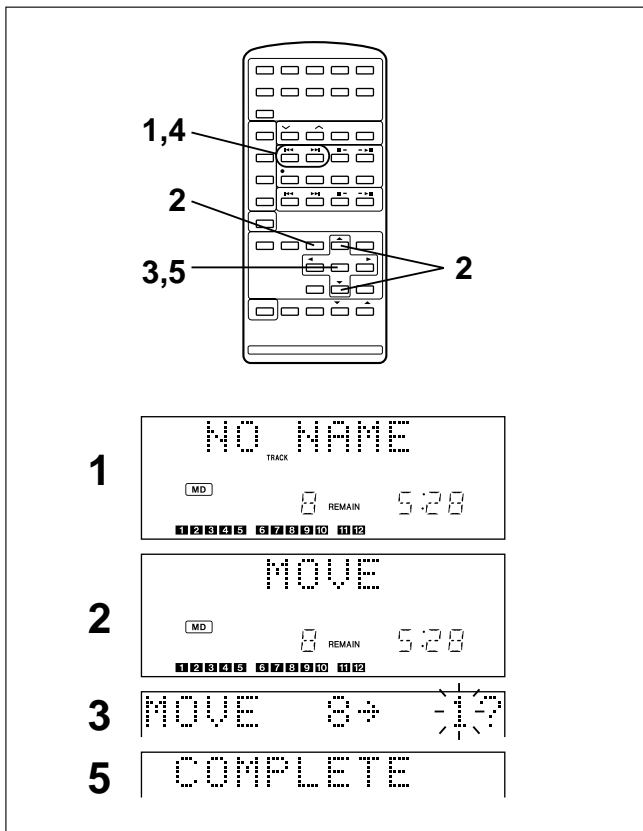

■ Move

- 1 While in the stop mode, select the track you wish to move using the ◀◀ or ▶▶ button.
- Start playing the track to be moved, and then press the MD ▶|| button.
- 2 Press the NAME/TOC EDIT button, and then select "MOVE" using the ▲ or ▼ button.
- 3 Within 10 seconds, press the ENTER button.
- 4 Select the direction to move the track using the ◀◀ or ▶▶ button.
 - To increase the track number ... ▶▶
 - To decrease the track number ... ◀◀
 - To cancel the operation, press the MD ■ button.
- 5 Press the ENTER button again.
 - The track is moved, and the unit is stopped at the beginning of the track.

Note:

- When a track has been moved, the other tracks which are affected will be assigned new track numbers automatically.

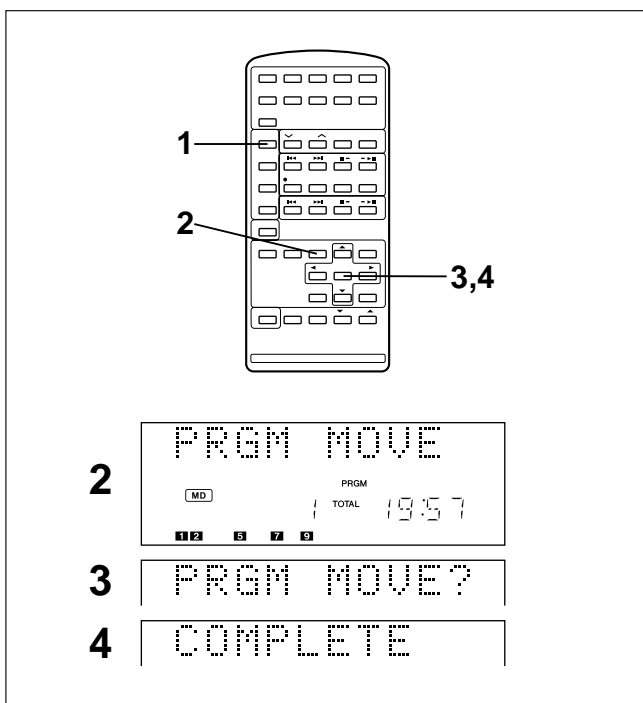

Programmed move:

- 1 Select the tracks you want to move and enter them into a program. (Page 14)
- 2 Make sure that the "PRGM" indicator is lit, and then press the NAME/TOC EDIT button.
- 3 Within 10 seconds, press the ENTER button.
 - To cancel the operation, press the MD ■ button.
- 4 Press the ENTER button again.
 - The tracks will be moved, and the programmed move mode will end.

Notes:

- The track numbers that are not included in the programmed selections will be put at the end of the new sequence.
- When the same track has been entered into the program twice or more, the last programmed position will have priority.



(Continued)

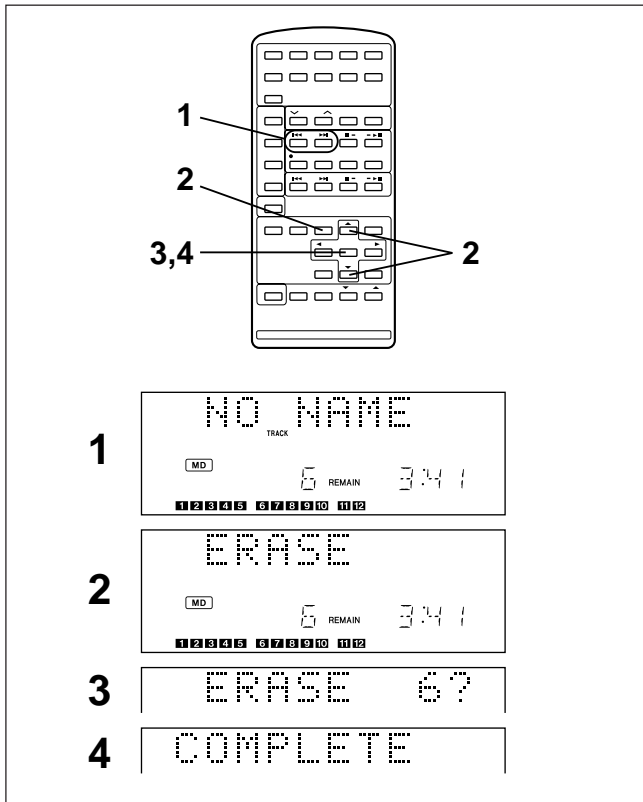

■ Erase

To erase tracks one at a time:

- 1 While in the stop mode, select the track to be erased using the ◀◀ or ▶▶ button.
 - Start playing the track you wish to erase, and press the MD ▶|| button.
- 2 Press the NAME/TOC EDIT button, and then select "ERASE" using the ▲ or ▼ button.
- 3 Within 10 seconds, press the ENTER button.
 - To cancel the operation, press the MD ■ button.
- 4 Press the ENTER button again.
 - The track is erased, and the unit is stopped at the beginning of the previous track.
 - When a track is erased, the numbers assigned to the tracks following the erased track will be automatically decreased by one.

Notes:

- Once a track has been erased, it cannot be recovered. Double-check the track number before erasing it.
- When a track is erased, the track name will be erased at the same time.

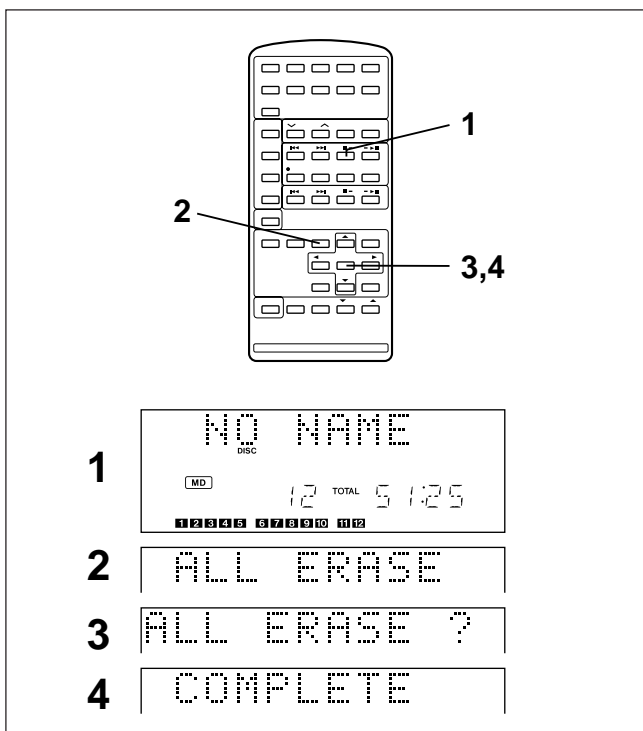

To erase all of the tracks at once:

- 1 Press the MD ■ button.
 - The total number of tracks and the total playing time for the MD will be displayed.
- 2 Press the NAME/TOC EDIT button, and then select "ALL ERASE" using the ▲ or ▼ button.
- 3 Within 10 seconds, press the ENTER button.
 - To cancel the operation, press the MD ■ button.
- 4 Press the ENTER button again.
 - All of the track numbers and track names will be erased.

(Continued)

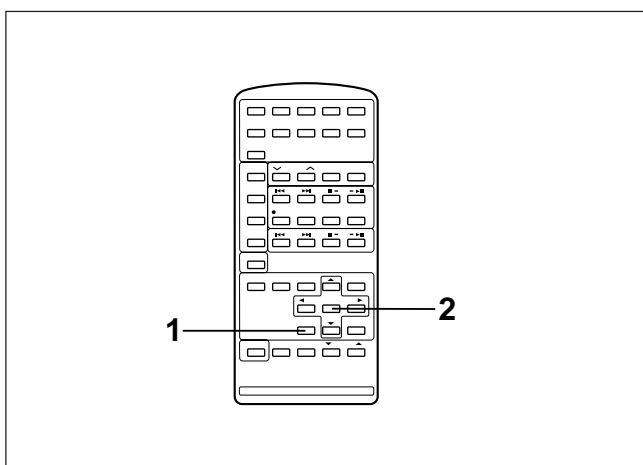
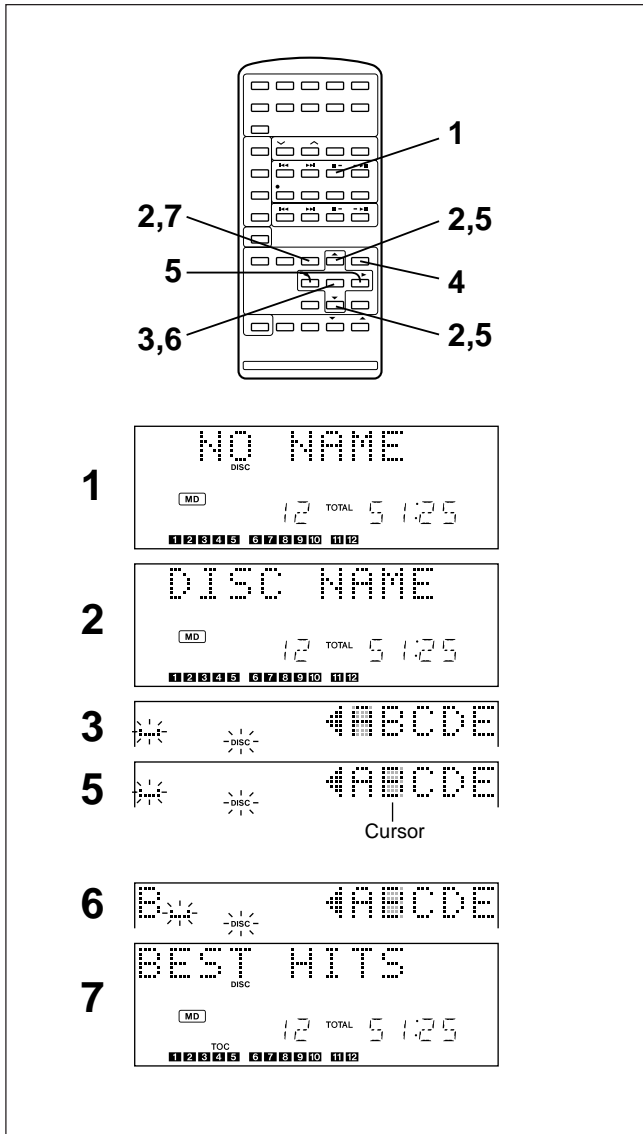

- Up to 255 tracks can be named on each disc, and each disc can be given a disc name.

Notes:

Number of characters you can enter

■ **Disc names and track names**

Up to 100 characters (including spaces) can be entered for each name. If more than 100 characters are entered, "NAME FULL" will appear.

■ **Total number of characters per MiniDisc**

A total of approximately 1700 characters can be used for all of the disc and track names. If more than 1700 characters are entered, "TOC FULL" will appear.

■ **To create a disc name**

- 1 Press the MD button.
 - The total number of tracks and the total playing time for the MD will appear.
- 2 Press the NAME/TOC EDIT button, and then select "DISC NAME" using the ▲ or ▼ button.
- 3 Within 10 seconds, press the ENTER button.
 - The unit will enter the character input mode.
- 4 Press the DISPLAY button to select the type of characters you want to use.

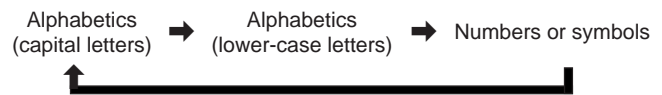

Type of characters	Characters
Capital letters	A B C D E F G H I J K L M N O P Q R S T U V W X Y Z . /
Lower-case letters	a b c d e f g h i j k l m n o p q r s t u v w x y z . /
Symbols	1 2 3 4 5 6 7 8 9 0 ! " # \$ % & ' () * + , - . / : ; < = > ? @ _ \

- 5 Select the character you wish using the ◀/▶/▲/▼ buttons.
 - When the ▲ or ▼ button is pressed, the following 5 letters will appear.
 - Each time the ◀ or ▶ button is pressed, the cursor will move to the next letter.
- 6 Press the ENTER button to enter the character.
 - Repeat steps 4 to 6 above to enter the characters of the name. When the next character's type is the same as the previous character, step 4 can be skipped.
- 7 After entering all of the characters in the name, press the NAME/TOC EDIT button.
 - The disc name will be recorded.

■ **To erase disc names**

After performing steps 1 to 3 mentioned above, do the following:

- 1 Press the TIMER/DELETE button for at least 2 seconds.
 - The "NAME CLEAR?" display will appear.
- 2 Press the ENTER button.
 - The disc name will be erased.



(Continued)

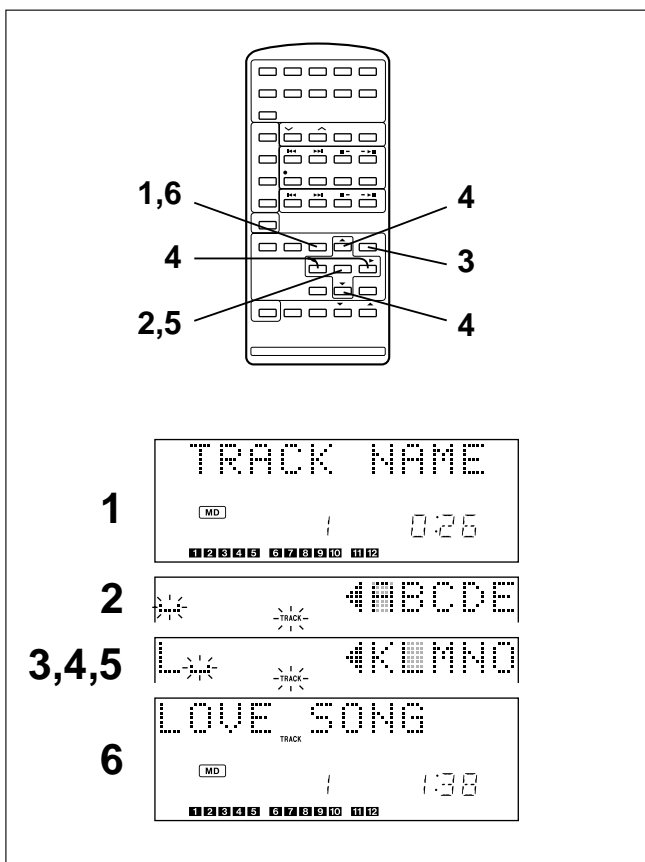

To create a track name

- 1 During playback, press the NAME/TOC EDIT button.
 - "TRACK NAME" will appear.
- 2 Within 10 seconds, press the ENTER button.
 - The unit will enter the character input mode.
 - The track you are listening to will be played repeatedly.
- 3 Press the DISPLAY button to select the type of characters. (Page 25)

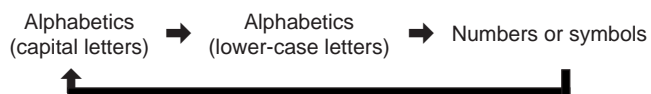

- 4 Select the character you want using the ◀/▶/▲/▼ buttons.
 - When the ▲ or ▼ button is pressed, the following 5 letters will appear.
 - Each time the ◀ or ▶ button is pressed, the cursor will move to the next letter.
- 5 Press the ENTER button to enter the character.
 - Repeat steps 3 to 5 above to enter characters in the name. When the next character's type is the same as the previous character, step 3 can be skipped.
- 6 After entering all of the characters in the name, press the NAME/TOC EDIT button.
 - The track name will be recorded.
 - The unit will return to normal playback.

Notes:

- The track name function can be used while in the stop mode (when selecting a track), in the pause mode, or in the recording mode. (Select "TRACK NAME" from the edit menu.)
- If you create a track name while recording the track, make sure you finish entering the name before you finish recording the track. If the end of the recording is reached before you have entered the complete name, only the characters entered before the recording ended will be recorded.

To erase track names

After performing steps 1 to 2 mentioned above, do the following:

- 1 Press the TIMER/DELETE button for at least 2 seconds.
 - The "NAME CLEAR?" display will appear.
- 2 Press the ENTER button.
 - The track name will be erased.

To erase a character

- 1 To correct a disc name, perform steps 1 - 3 on page 25. To correct track names, perform steps 1 - 2 on page 26.
- 2 Press the CURSOR << or >> button to make the character you wish to erase begin flashing.
- 3 Press the TIMER/DELETE button.
 - The specified character will be erased.
- 4 Press the NAME/TOC EDIT button.

To add a character

- 1 To correct a disc name, perform steps 1 - 3 on page 25. To correct track names, perform steps 1 - 2 on page 26.
- 2 Press the CURSOR << or >> button to make the character at the position where you wish to add a character begin flashing.
- 3 Select the character you want to add, using the ◀/▶/▲/▼ buttons.
- 4 Press the ENTER button.
 - A letter will be added, and the original letters will move to the right by one.
- 5 Press the NAME/TOC EDIT button.



ENTERING CHARACTERS

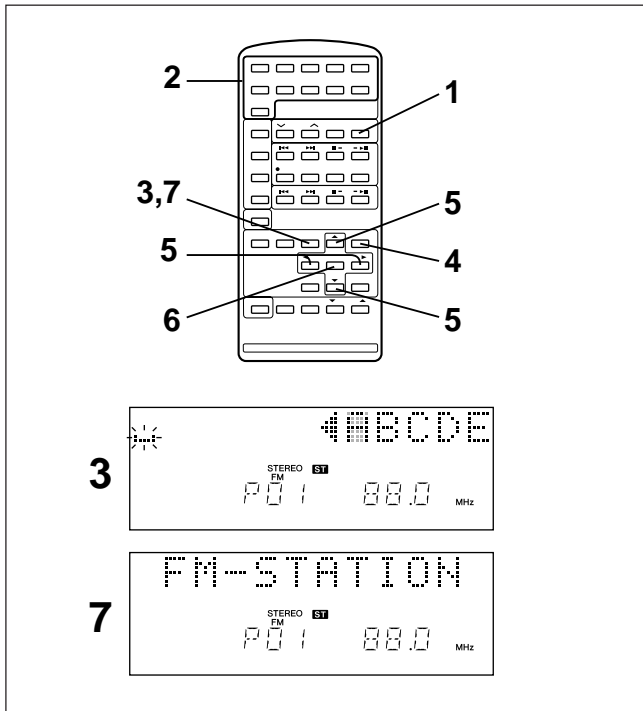

Note:

- You can enter up to 12 characters.
You cannot save a name with more than 12 characters.

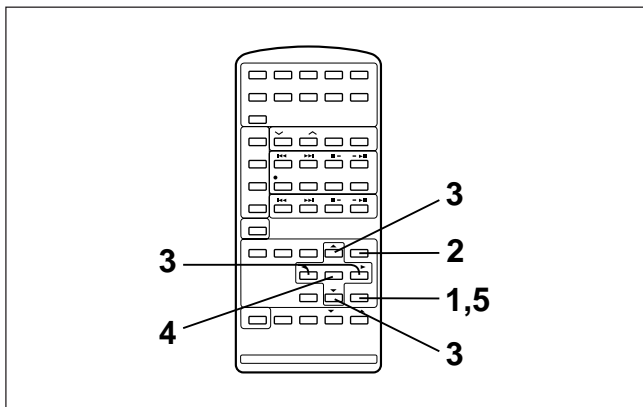

Note:

- When the power is on and you do not make any changes or press any buttons for at least 5 minutes (while in the CD or MD playback mode), the message will be displayed.

To create names for radio stations that have been stored in memory

- Press the TUNER (BAND) button.
- Select the location number you want to name.
- Press the NAME/TOC EDIT button.
- Press the DISPLAY button to select the type of characters you want to use. (Page 25)
Alphabetic (capital letters) → Alphabetic (lower-case letters) → Numbers or symbols
- Select the character you wish using the ◀/▶/▲/▼ buttons.
- Press the ENTER button to enter the character.
 - Repeat steps 4 to 6 above to enter the characters of the name. When the next character's type is the same as the previous character, step 4 can be skipped.
- After entering all of the characters in the name, press the NAME/TOC EDIT button.
 - The name will be recorded.

To erase a name:

After performing steps 1 to 3 mentioned above, do the following:

- Press the TIMER/DELETE button for at least 2 seconds.
 - The "NAME CLEAR?" display will appear.
- Press the ENTER button.
 - The name will be erased.

To change the message displayed when the power is turned off

It is possible to change the message displayed on the LCD when the power is off, to suit your preference. The default message is "ENJOY MUSIC!". This can be changed to any other message you choose, up to 20 characters in length.

- Press the MESSAGE button.
 - The unit will enter the character input mode.
- Press the DISPLAY button to select the type of characters you want to use. (Page 25)
Alphabetic (capital letters) → Alphabetic (lower-case letters) → Numbers or symbols
- Select the character you wish using the ◀/▶/▲/▼ buttons.
- Press the ENTER button to enter the character.
 - Repeat steps 2 to 4 above to enter the characters of the name. When the next character's type is the same as the previous character, step 2 can be skipped.
- After entering all of the characters in the name, press the MESSAGE button.
 - The message will be recorded.
- Turn the power off, and check the contents of the programmed message.

To erase a programmed message:

- Press the MESSAGE button.
- Press the TIMER/DELETE button for at least 2 seconds.
 - The "NAME CLEAR?" display will appear.
- Press the ENTER button.
 - The programmed message will be erased, and the display will return to "ENJOY MUSIC!".





(Continued)

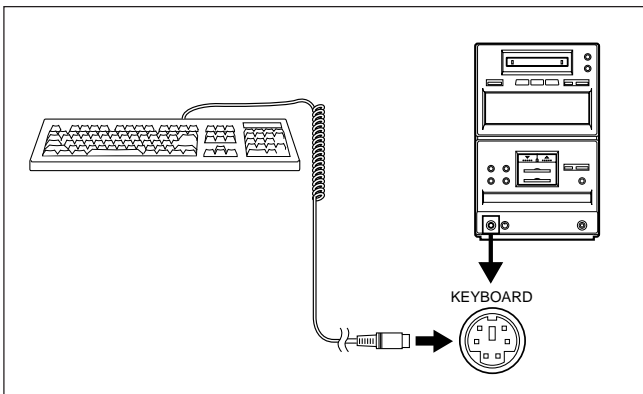
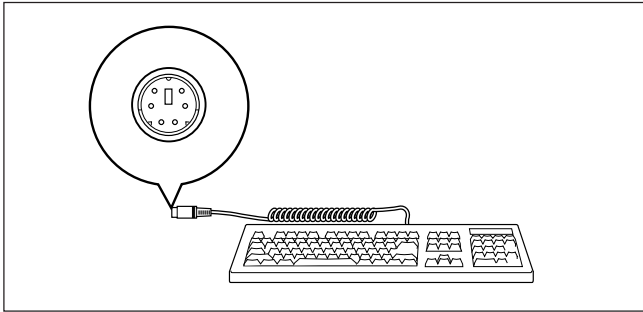

■ To enter characters from a computer keyboard

You can enter characters by connecting a keyboard.

Compatible keyboards :

You can use any keyboard that can be connected to an IBM compatible PC which has the plug shape shown to the left. (Macintosh keyboards cannot be used.)

- 1 Connect a keyboard to the KEYBOARD terminal when the power to the main unit is off.
- 2 Press the POWER button to turn the power on.
- 3 Proceed to any of the unit's functions in which you can enter characters.
 - To create a disc name on an MD : Perform steps 1-3 on page 25.
 - To create a track name on an MD : Perform steps 1-2 on page 26.
 - To create names for radio stations that have been stored in memory : Perform steps 1-3 on page 27.
 - To change the message displayed when the power is turned off : Perform step 1 on page 27.
- 4 Then, enter the characters you want from the keyboard.

Note:

- Do not plug in or unplug the keyboard plug while the power is on, as this may lead to damage.

Keys you can use :

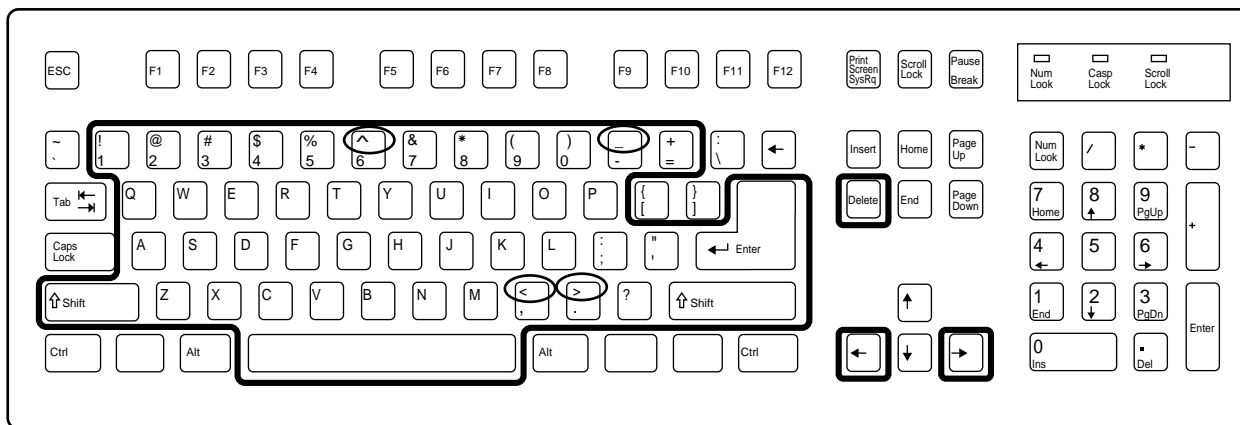

Characters shown with the ○ mark cannot be entered.

Entering characters:

Normally, lower-case letters are entered.

Shift key : When the shift key is held down and any letter key is pressed, an upper-case letter will be entered.

Space key : Enters a space and moves the cursor one character to the right.

Delete key : This key has the same function as the TIMER/DELETE button.

The letter under the cursor will be erased, and the letters to the right will move one character to the left.

Enter key : This key has the same function as the NAME/TOC EDIT button.

However, although the letters you enter can be checked after they are entered, the unit cannot be put in the editing mode for changing characters already entered.

← key : This key has the same function as the << button. The cursor will move one character to the left.

→ key : This key has the same function as the >> button. The cursor will move one character to the right.

The other keys on the keyboard are disabled.





HOW TO USE THE BUILT-IN TIMER

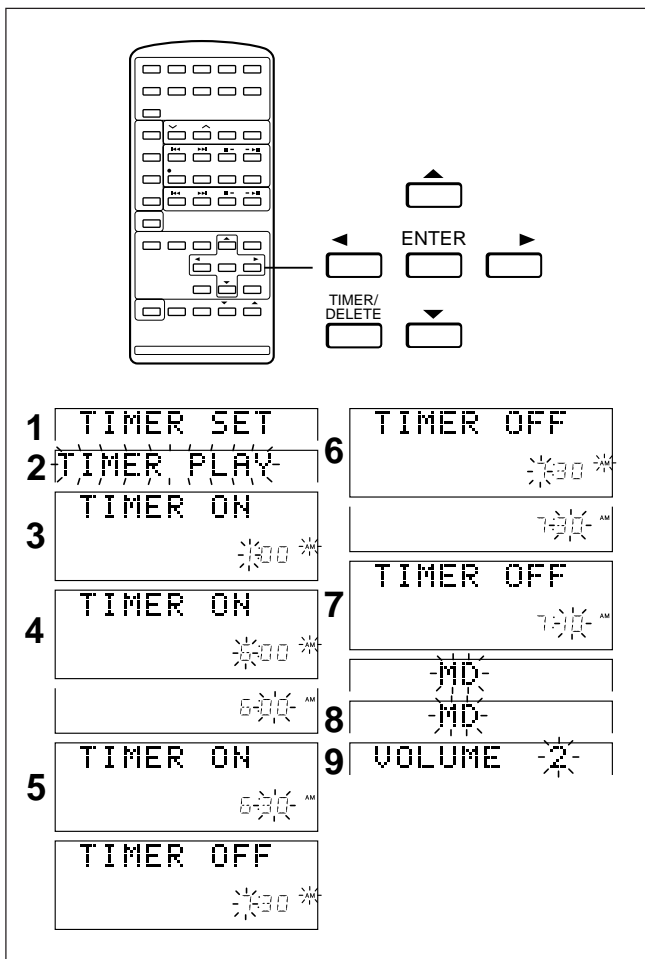

■ Timer playback

Before timer playback, the following preparations are required.

- Make sure that the clock setting is correct. (Page 8)
- Load a CD or a MD.
- Preset the radio station. (Page 12)

Programming for timer playback:

- 1 While in the stop mode, press the TIMER/DELETE button and then the ▲ or ▼ button so that the TIMER SET display appears.
- 2 Within 10 seconds, press the ENTER button, and then select the timer mode using the ▲ or ▼ button.
- 3 Press the ENTER button.
 - The start time setting display will appear.
- 4 Enter the hour for the start time using the ◀ or ▶ button. Then, press the ENTER button.
- 5 Enter the minute using the ◀ or ▶ button. Then, press the ENTER button.
 - The stop time setting display will appear.
 - The display time will increase by one hour automatically.
- 6 Enter the hour for the stop time using the ◀ or ▶ button. Then, press the ENTER button.
- 7 Enter the minute using the ◀ or ▶ button. Then, press the ENTER button.
 - The start and stop times are now set.
- 8 Select the source program using the ◀ or ▶ button.
 - The source is selected in the following sequence:
MD → CD → TUNER → AUX → DIGITAL1 → DIGITAL2 → PHONO
- 9 Press the ENTER button.
 - If TUNER is selected, press the ENTER button, and then select the preset number using the ◀ or ▶ button.
- 10 Adjust the volume level using the ◀ or ▶ button.
- 11 Press the ENTER button.
 - Timer playback setting is complete.

Note:

- If you do not perform the next operation within 10 seconds, the operation will be canceled. If this happens, try the operation again from the beginning.

Setting timer playback:

- 1 Press the TIMER/DELETE button.
 - Press the ▲ or ▼ button so that the T-STANDBY display appears.
- 2 Press the ENTER button.
 - The settings will appear in order, and the unit will enter the timer playback standby mode. (If the power is on, the unit will be turned off.)
- 3 When the timer playback start time is reached, the power will be turned on and the volume will gradually increase to the preset position.

When the timer playback stop time is reached, the power will be turned off automatically.

Notes:

- When the CD or MD is played to the end, playback will stop before the stop time.
If you wish to play to the stop time, set repeat play for the CD or MD.
- The timer playback with this unit cannot be used to control equipment connected to this unit. You must use the timer of the other equipment, if it has one.
- The timer playback and timer recording functions cannot be used at the same time.

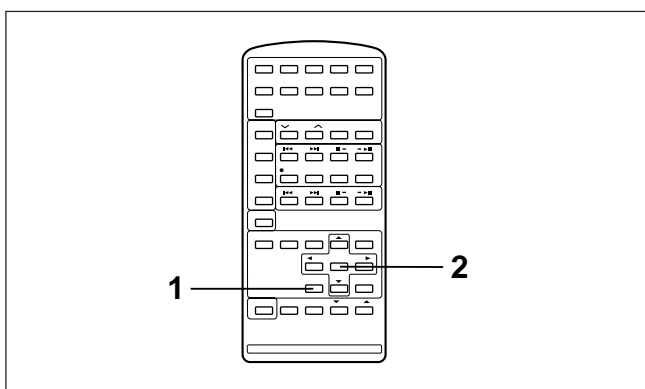

(Continued)

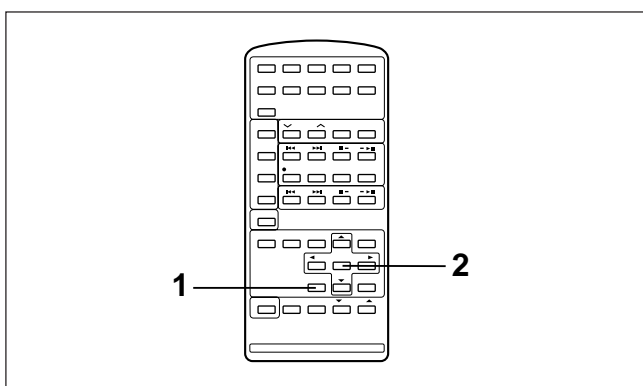
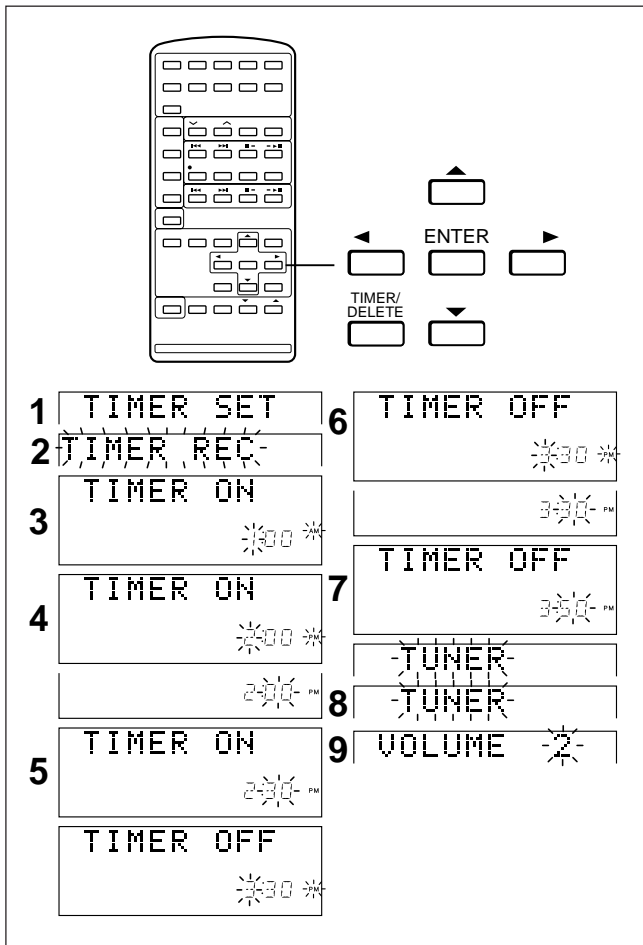

Notes:

- You cannot make a timer recording using CDs.
- The timer recording with this unit cannot be used to control equipment connected to this unit. You must use the timer of the other equipment, if it has one.
- The timer playback and timer recording functions cannot be used at the same time.

In the following cases, the timer recording function will not work.

- When a MiniDisc has not been inserted.
- When a playback-only MiniDisc is inserted.
- When the MiniDisc you inserted is protected against accidental erasure.
- When there is no recording space left on the MiniDisc you have inserted (when the "TOC FULL" or "DISC FULL" messages appear)

■ Timer recording

Before timer recording, the following preparations are required.

- Make sure that the clock setting is correct. (Page 8)
- Load a recordable MD.
- Preset the radio station. (Page 12)

Programming for timer recording:

- 1 While in the stop mode, press the TIMER/DELETE button, and then the ▲ or ▼ button so that the TIMER SET display appears.
- 2 Within 10 seconds, press the ENTER button, and then select the timer mode using the ▲ or ▼ button.
- 3 Press the ENTER button.
 - The start time setting display will appear.
- 4 Enter the hour for the start time using the ◀ or ▶ button. Then, press the ENTER button.
- 5 Enter the minute using the ◀ or ▶ button. Then, press the ENTER button.
 - The stop time setting display will appear.
 - The display time will increase by one hour automatically.
- 6 Enter the hour for the stop time using the ◀ or ▶ button. Then, press the ENTER button.
- 7 Enter the minute using the ◀ or ▶ button. Then, press the ENTER button.
 - The start and stop times are now set.
- 8 Select the source program using the ◀ or ▶ button.
 - The source is selected in the following sequence:
TUNER → AUX → DIGITAL1 → DIGITAL2 → PHONO
- If TUNER is selected, press the ENTER button, and then select the preset number using the ◀ or ▶ button.
- 9 Press the ENTER button.
- 10 Adjust the volume level using the ◀ or ▶ button.
- 11 Press the ENTER button.
 - Timer recording setting is complete.

Note:

- If you do not perform the next operation within 10 seconds, the operation will be canceled. If this happens, try the operation again from the beginning.

Setting timer recording:

- 1 Press the TIMER/DELETE button.
 - Press the ▲ or ▼ button so that the T-STANDBY display appears.
- 2 Press the ENTER button.
 - The settings will appear in order, and the unit will enter the timer recording standby mode. (If the power is on, the unit will be turned off.)
- 3 When the timer recording start time is reached, the power will be turned on to start recording.

When the timer recording stop time is reached, the power will be turned off automatically.



(Continued)

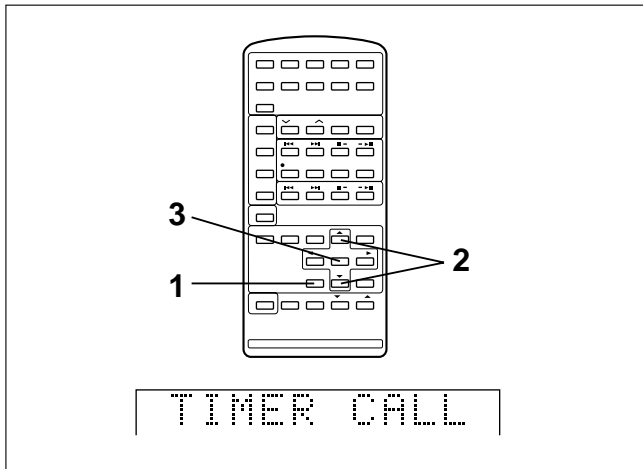

■ **To check the timer setting**

- 1 While in the timer standby mode, press the TIMER/DELETE button.
 - 2 Press the ▲ or ▼ button so that the TIMER CALL display appears.
 - 3 Within 10 seconds, press the ENTER button.
- The timer settings will appear in order, and then the original display will reappear.

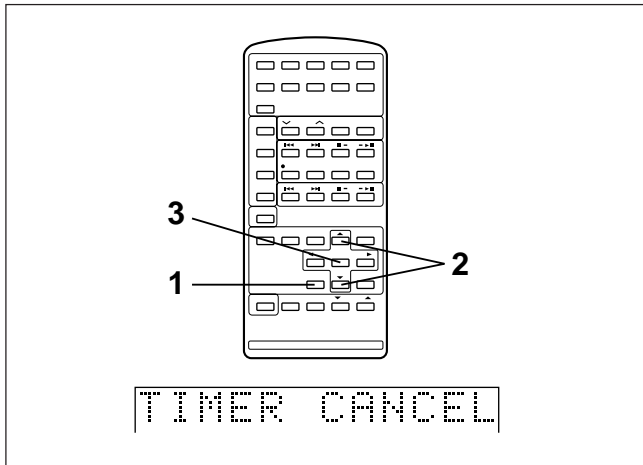

■ **To cancel the timer operation**

If the power is turned on, the timer will be canceled. The timer operation can also be canceled as follows.

- 1 While in the timer standby mode, press the TIMER/DELETE button.
 - 2 Press the ▲ or ▼ button so that the TIMER CANCEL display appears.
 - 3 Within 10 seconds, press the ENTER button.
- The timer operation will be canceled. ("TIMER" or "TIMER REC" will go off.) The start and stop times will be stored.





(Continued)

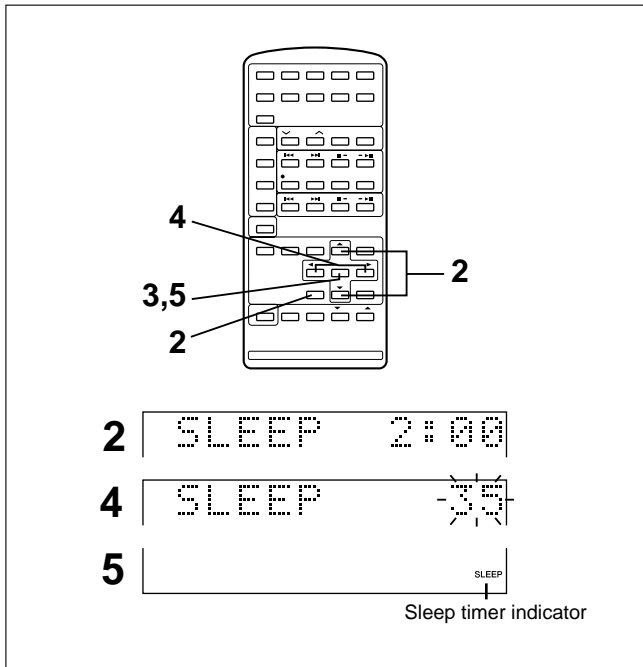

■ Sleep operation

The radio, compact disc and MiniDisc can all be turned off automatically.

- 1 Play the desired sound source.
 - 2 Press the TIMER/DELETE button, and then press the ▲ or ▼ button so that the SLEEP display and setting time appear.
 - 3 Within 10 seconds, press the ENTER button.
- If you wish to use the displayed time, press the ENTER button.

To change the sleep timer:

- 4 Set the sleep time using the ◀ or ▶ button.
- The setting time is changed in 5-minute increments between 2 hours and 5 minutes, or 1 minute increments between 5 minutes and 1 minute.
- 5 Press the ENTER button.
- The sleep operation will start.
- When it is one minute before the programmed sleep time, the volume will be reduced gradually. During this period, you cannot change the volume.
- 6 The unit will be turned off automatically after the preset sleep time has elapsed.

Notes:

- Once the sleep time is set, it will remain the same until the setting is changed.
- This sleep functions of this unit cannot be used to control equipment connected to this unit. You must use the sleep functions of the other equipment, if it has them.

To confirm the sleep timer setting:

- 1 Press the TIMER/DELETE button.
- 2 Press the ▲ or ▼ button so that the SLEEP display and setting time appear.

To cancel the sleep operation:

If the power is turned off, the sleep operation will be canceled. The timer operation can also be canceled as follows if the power cannot be turned off during recording.

- 1 Press the TIMER/DELETE button.
- 2 Press the ▲ or ▼ button so that the SLEEP OFF display appears.
- 3 Within 10 seconds, press the ENTER button.
- The sleep operation will be canceled. ("SLEEP" will go off.)

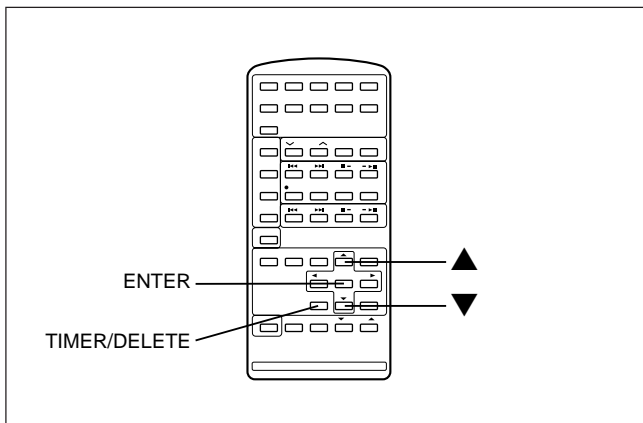

■ Simultaneous sleep and timer operation

- 1 Play the desired item (compact disc, MiniDisc, etc.).
- 2 Set the sleep timer.
- 3 Set timer playback.
- When the preset sleep time has elapsed, the power will be automatically turned off. When the timer start time is reached, the power will be turned on again.





USING EXTERNAL UNITS

■ Connecting external units

Before connecting external units, turn the power to this unit and external units off.

Connecting this unit to a DSS tuner or a DAT (equipment which can output digital signals)

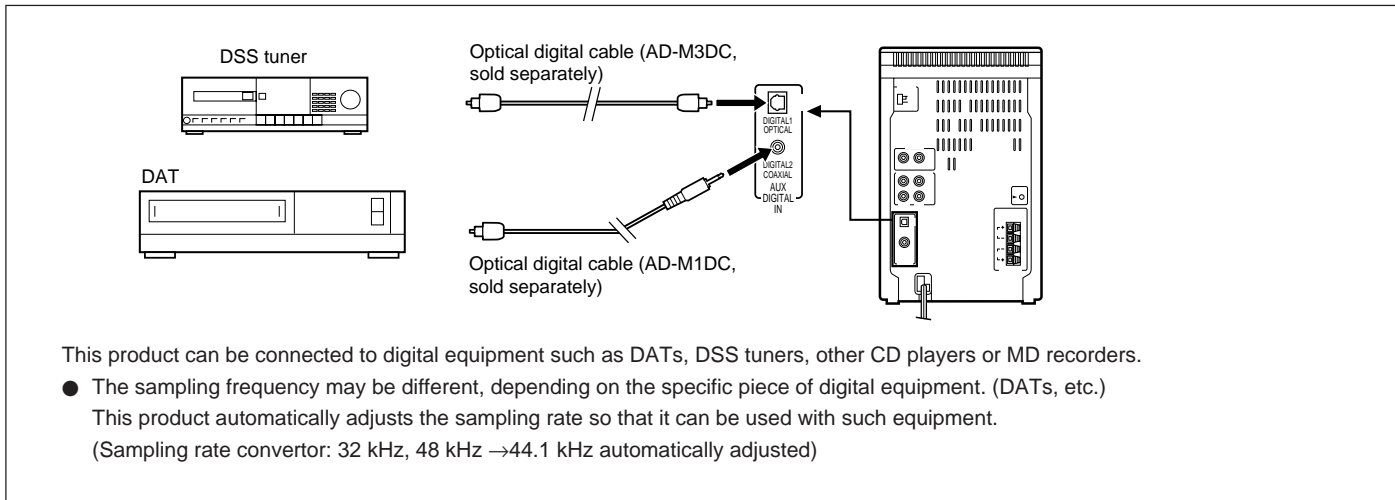

Connecting to stereos or MD/CD players (equipment which can output analog signals)

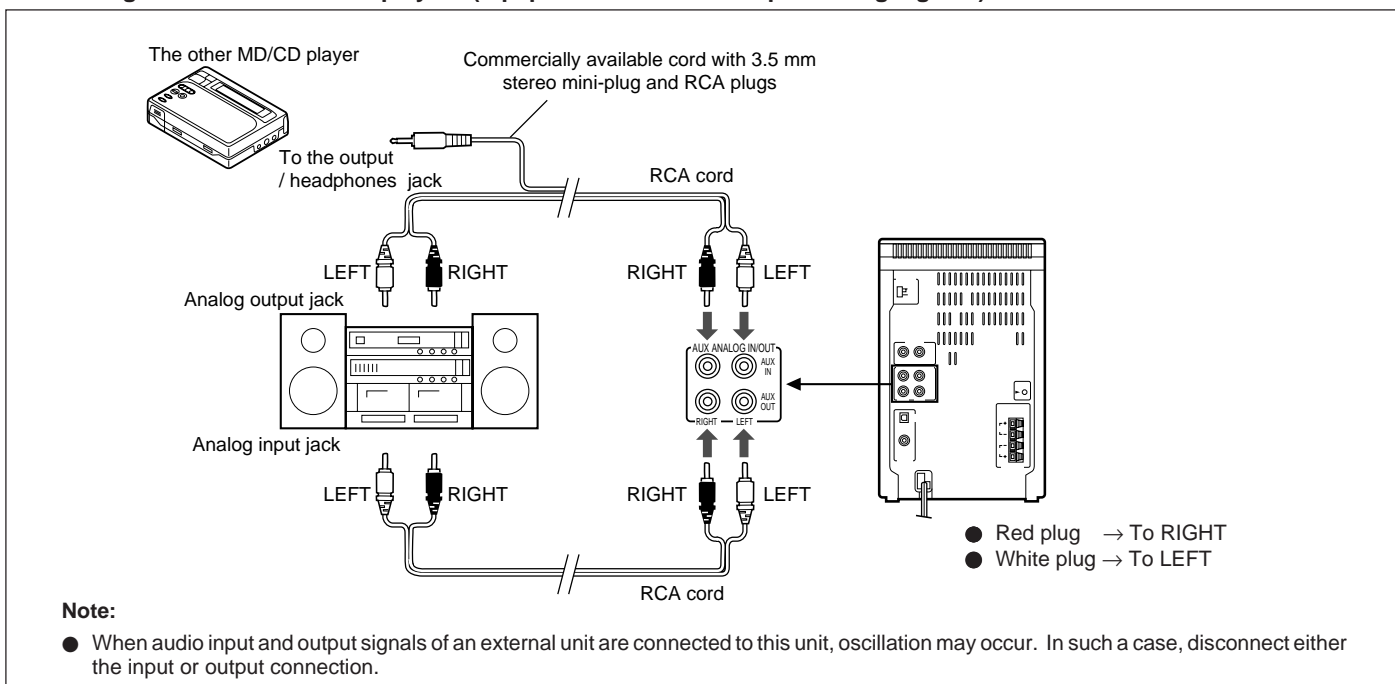

Connecting to a stereo turntable

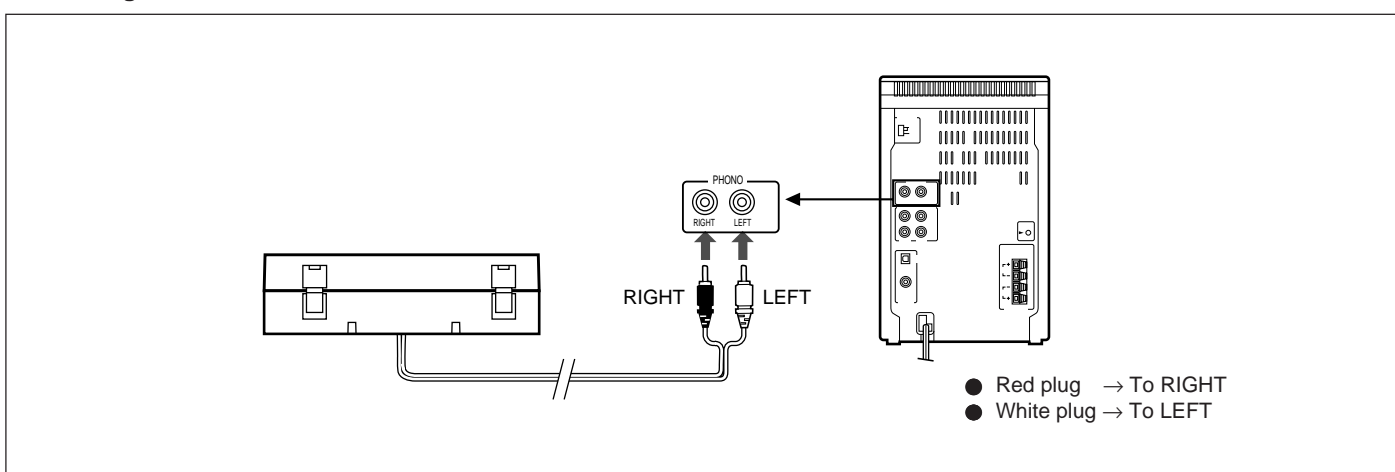



(Continued)

Headphones

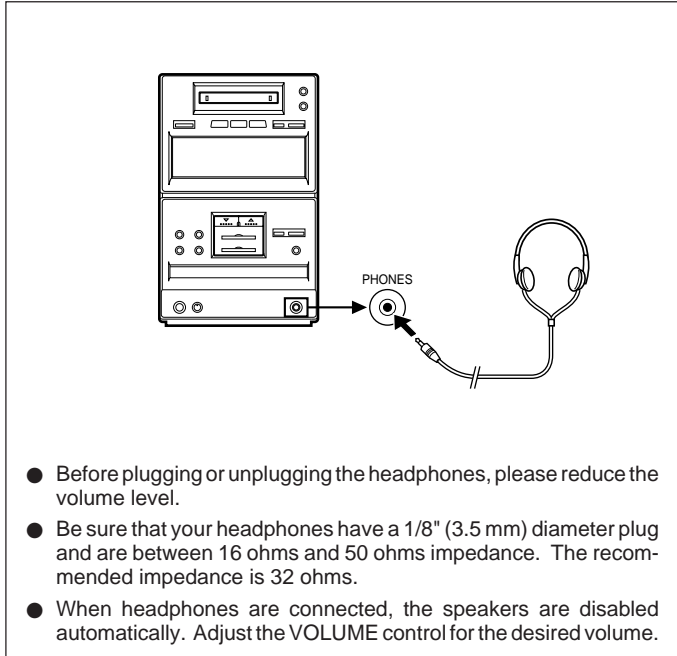



(Continued)

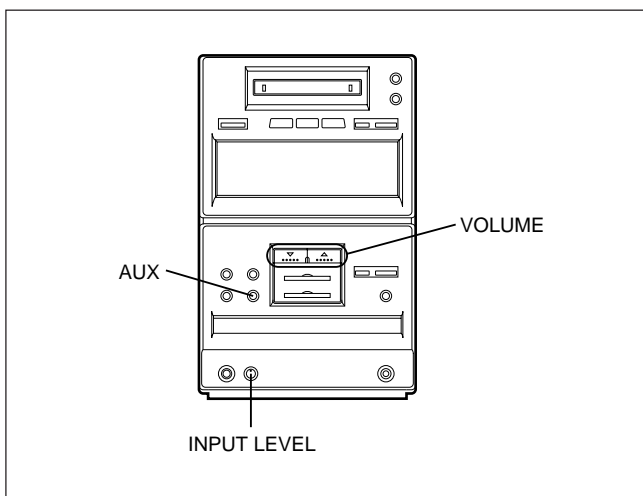

■ Listening to sound from an external unit

To listen to sound from an external unit connected to the digital input terminal:

- 1 Press the AUX button.
AUX → AUX1 DIGITAL → AUX2 DIGITAL → PHONO
- To select "AUX1 DIGITAL" or "AUX2 DIGITAL".
- 2 Start playback on the external unit.
- 3 Adjust the sound level using the VOLUME buttons of this unit.

To listen to sound from an external unit connected to the analog input terminals:

- 1 Press the AUX button.
AUX → AUX1 DIGITAL → AUX2 DIGITAL → PHONO
- To select "AUX" or "PHONO".
- 2 Start playback on the external unit, and adjust the input sound level using the INPUT LEVEL control.
- When the INPUT LEVEL control is set to Min, no sound is obtained.
- The maximum level should not exceed "0 dB".
- 3 Adjust the volume using the VOLUME buttons on this unit.

■ Recording sound from an external unit

To start recording the moment the external unit starts playback (synchro recording):

MD recording will start automatically, as soon as playback starts on the external unit. This applies to both digital inputs and analog inputs.

- The space-cut function will work automatically during synchro recording.
- 1 Load a recordable MiniDisc.
 - 2 Press the AUX button.
 - Select the input that corresponds to the terminals where the external unit you will record from is connected.
 - 3 Play the recording on the external unit, and adjust the recording level using the INPUT LEVEL control. (This is only necessary when recording from analog inputs.)
 - In the case of digital inputs, it is not necessary to adjust the recording level.
 - The maximum level should not exceed "0 dB".
 - Adjust the recording level, and then stop the external unit.
 - 4 Press the S. SYNC button.
 - 5 Start playing the music you want to record on the external unit.
 - Recording will start automatically.
 - 6 When playback has finished on the external unit, this unit will automatically enter the recording stand-by mode.
 - Cancel the mode by pressing the MD ■ button.
When the MD ■ button is pressed, the TOC will be recorded.
If you want to perform other operations at this point, wait until this display disappears.

What is the space-cut function?

If there is silence in the playback signal that lasts 4 seconds during a synchro recording, the recording will stop automatically and the unit will enter the recording stand-by mode. Then, when sound from the playback unit resumes, recording will automatically restart. (A space of 4 seconds is placed between tracks.)

- If there is noise between tracks of the sound source, the synchro recording or the space-cut function may not work properly. If this happens, make the recording manually.
- When you need to record tracks or audio that include very quiet passages lasting 4 seconds or more, manual recording is recommended.

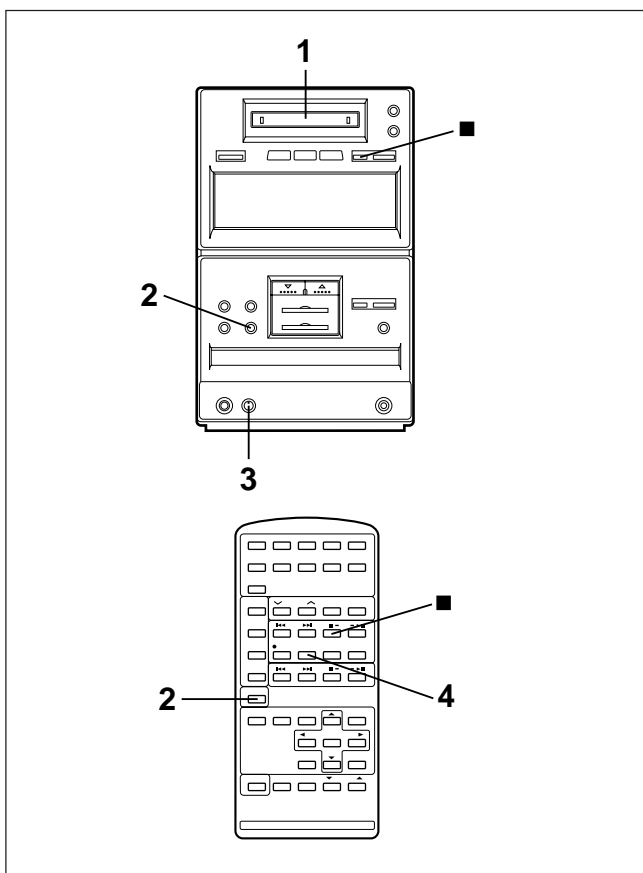

To stop recording:

Press the MD ■ button.

Note:

- On some CD players, the track numbers cannot be recorded automatically.



(Continued)

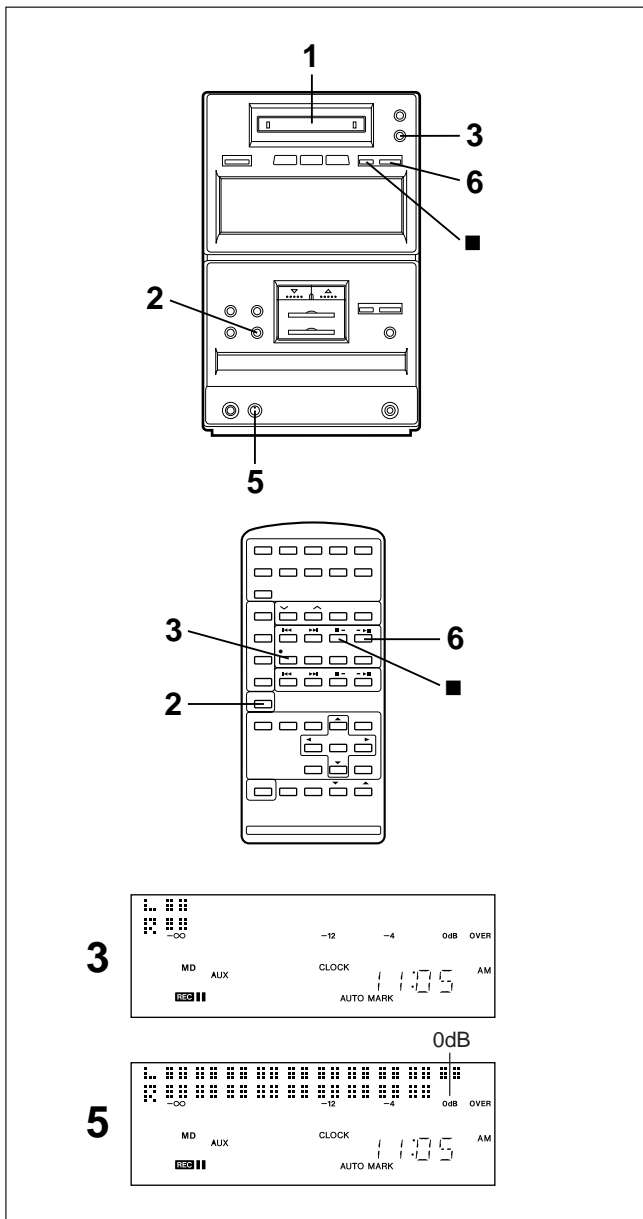

To start a recording by yourself (manual recording):

While you are listening to the playback sound from an external unit (tuners, CDs, etc.), you can start recording by yourself anytime.

- 1** Load a recordable MiniDisc.
- 2** Press the AUX button.
 - Select the input that corresponds to the terminals where the external unit you will record from is connected.
- 3** Press the ● REC button.
 - The unit will enter the recording stand-by mode.
 - When you do not want to use the auto mark function, press the A. MARK button on the remote control.
- 4** Start playing the music you want to record on the external unit.
- 5** Adjust the recording level using the INPUT LEVEL control. (This is only necessary when recording from analog inputs.)
 - The maximum level should not exceed "0 dB".
 - In the case of digital inputs, it is not necessary to adjust the recording level.
- 6** Press the MD ►|| button.

To stop recording:

Press the MD ■ button.





WHAT IS A MINIDISC?

The disc is stored in a cartridge. You can handle it easily without worrying about dust, fingerprints, etc. However, dust entering the opening of the cartridge, dirt on the cartridge, etc. may cause malfunctions. Please note the following.

■ Handling MiniDiscs

Do not touch the disc directly!
Do not open the shutter or touch the disc directly. If the shutter is opened forcibly, it may break.

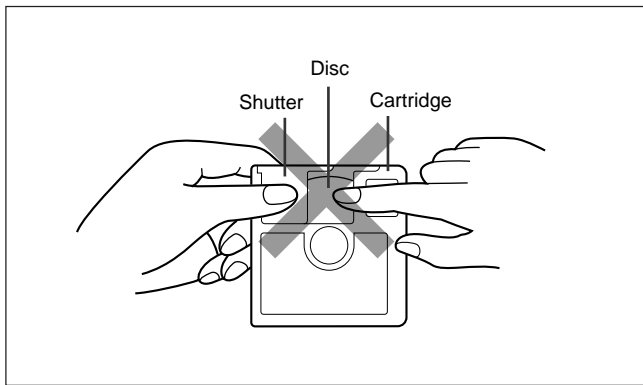

Where not to store discs:

Do not store discs in places with high temperatures or humidity. Specifically, do not leave discs in places exposed to direct sunlight or in cars with doors and windows closed. Do not leave discs in places where sand can get into the cartridge easily (e.g., a beach).

Regular cleaning:

If the surface of the cartridge becomes dusty or dirty, clean it with a soft, dry cloth.

■ To prevent recorded discs from being erased accidentally (accidental erasure prevention)

Slide the accidental erasure prevention tab, located on the side of the disc, in the direction indicated by the arrow.

- The disc will then be protected against accidental erasure.
- To add a recording to such a disc, slide the accidental erasure prevention tab back to its original position.

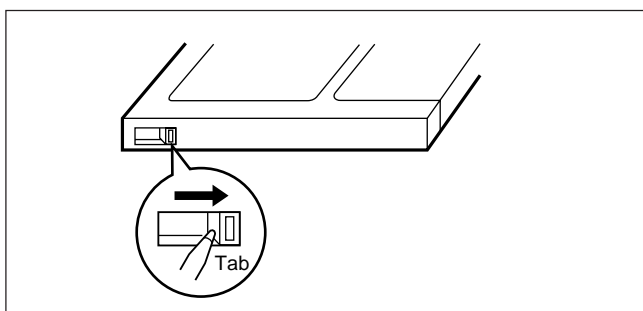

■ What is a MiniDisc?

- A MiniDisc is a 2-1/2" (64-mm) diameter disc which is stored in a cartridge. MiniDiscs are easy to handle, compared with compact discs, because they are protected against dust and scratches.
- Recording and playback use a digital system with a sound quality that is similar to that with compact discs.

MiniDiscs cannot twist or stretch like tapes. The quality of sound will not deteriorate. MiniDiscs are extremely durable.

- Never disassemble a MiniDisc.

■ Adaptive TRansform Acoustic Coding

[ATRAC]

ATRAC (Adaptive TRansform Acoustic Coding) is a new technology that is designed to eliminate the information in sounds which you can not hear and to compress the remaining sound data so that the recording uses about 1/5 of the original sound information.

Sound data is analyzed and filtered to take advantage of psycho acoustic masking. The acoustic quality of the sound is not impaired.

■ Types of discs

There are two types of MiniDiscs: playback-only and recordable type.

● Playback-only MiniDisc:

This type of MiniDisc is used for commercially available pre-recorded music. This is the same kind of optical disc as a CD. Playback is performed using an optical pickup. (Recording and editing are not possible.)

A shutter is used on only one side (back).

● Recordable MiniDisc:

This is a "blank disc" which recording can be performed. A magneto optical disc is used.

Recordings are made using a laser and a magnet. Repeated recording is possible.

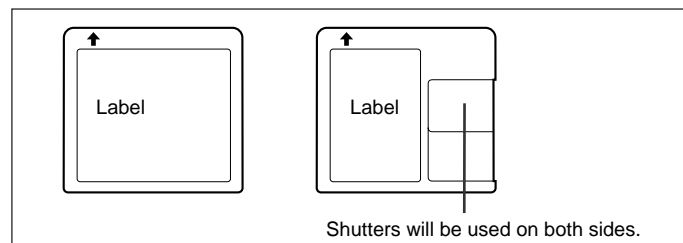

Shutters will be used on both sides.

■ Helpful tip when attaching labels

To attach labels on MD cartridges, be sure to observe the following:

If a label is not properly attached, the MD may jam inside the unit and it may not be possible to remove it.

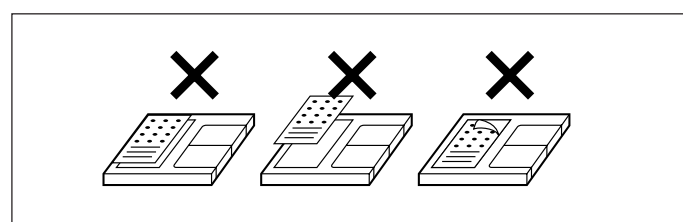

- Only attach labels in the specified location. (Do not put labels anywhere else.)
- Do not put a label on top of another one.
- If a label is peeled off or it lifts away, replace it with a new one.

■ Shock-Resistant Memory

During playback, approximately 10 seconds of information is stored in the semiconductor memory. Therefore, even when the pickup cannot read information for a second or two because of external shock, the sound continues without interruption because the information stored in memory is output.





MINIDISC SYSTEM LIMITATIONS

Even if the maximum recording time of a MiniDisc is not reached, "DISC FULL" or "TOC FULL" may be displayed.	When the number of tracks used reaches the limit, regardless of the remainder being recording time, further recording will be impossible. (Maximum number of tracks: 255)
Even if the number of tracks and the recording time have not reached the limit, "DISC FULL" may be displayed.	When emphasis information (equalizer treatment in the treble section) in a track switches on/off many times, each change is assumed to be the beginning of a new track, which will quickly use up all available track numbers, making further recording impossible, regardless of the remaining time, recording time or the number of tracks on the original.
Even if several short tracks are erased, the remaining recording time may not show an increase.	When the remaining recording time of a disc is displayed, short tracks less than 15 seconds long may not be included in the total.
Two tracks may not be combined in editing.	For MiniDiscs which repeated recording and editing operations were performed, the COMBINE function may not work.
The total of the recorded time and time remaining on a disc may not add up to the maximum possible recording time.	A cluster (about 2 seconds) is normally the minimum unit of recording. So, even if a track is less than 2 seconds long, it will use about 2 seconds of space on the disc. Therefore, the time actually available for recording may be less than the remaining time displayed. If there are scratches on a disc, those sections will be automatically avoided (no recording will be placed in those sections). Therefore, recording time will be reduced.

TROUBLESHOOTING

■ If a problem occurs

If this unit functions abnormally during operation, first check the following items. If the unit continues to function abnormally, or if an abnormality appears other than listed below, turn off the player's power and disconnect the AC power plug, then consult your SHARP dealer or service personnel.

General

SYMPTOM	POSSIBLE CAUSE	REMEDY
• The clock is wrong.	• Did a power failure occur?	• Try setting it again.
• When a button is pressed, the unit does not respond.	—	• Turn the power off and on again, and then retry the operation.
• No sound is heard.	• Are the speaker wires disconnected? • Is the volume level set to "0"? • Are the headphones connected?	• Connect the wires securely. • Increase the volume level. • Disconnect the headphones.
• Radios make unusual noise or the picture on the TV screen is distorted.	• When a radio or TV which uses an indoor antenna is placed near the unit, the picture on the TV screen may be distorted or the radio may not function properly.	• It is recommended that you use an outdoor antenna.

CD playback

SYMPTOM	POSSIBLE CAUSE	REMEDY
• Even though a disc has been loaded, "NO DISC" or "ERROR" is displayed.	• The disc is loaded upside down. • The disc is very dirty.	• Load the disc with the correct side up. • Clean the disc.
• Playback stops in the middle of a track, or playback is not performed properly.	• The disc which does not satisfy the standards. • Is the unit located near excessive vibrations?	• Load the correct disc. • Place the unit on a firm, level surface free from vibration.
• Playback sounds are skipped.	• Has condensation formed inside the unit?	• Remove the disc and leave the power turned on. The unit should function properly in about 1 hour.



(Continued)

MD recording and playback

SYMPTOM	POSSIBLE CAUSE	REMEDY
<ul style="list-style-type: none"> A recording cannot be made. 	<ul style="list-style-type: none"> Is the MiniDisc protected against accidental erasure? Did you try to record on a playback-only MiniDisc? Can you see the "TOC FULL" message in the display? 	<ul style="list-style-type: none"> Slide the accidental erase prevention tab back to its original position. Replace it with a recordable disc. Put in another recordable disc with recording space on it.
<ul style="list-style-type: none"> Even though a disc has been loaded, "NO DISC" or "ERROR" is displayed. Playback sounds are skipped. 	<ul style="list-style-type: none"> The disc is very dirty. Is the unit located near excessive vibrations? Has condensation formed inside the unit? 	<ul style="list-style-type: none"> Clean the disc. Place the unit on a firm, level surface free from vibration. Remove the disc and leave the power turned on. The unit should function properly in about 1 hour.

Radio reception

SYMPTOM	POSSIBLE CAUSE	REMEDY
<ul style="list-style-type: none"> Radios make unusual noise consecutively. 	<ul style="list-style-type: none"> The unit is placed near the TV or computer. The antenna direction is not placed properly. 	<ul style="list-style-type: none"> Place the unit apart from the noise. Correct the antenna direction.
<ul style="list-style-type: none"> The preset channel cannot be called. 	<ul style="list-style-type: none"> Did a power failure occur? 	<ul style="list-style-type: none"> Preset the channel again.

Remote control

SYMPTOM	POSSIBLE CAUSE	REMEDY
<ul style="list-style-type: none"> The remote control does not function or does not operate properly. 	<ul style="list-style-type: none"> The batteries (polarity) are not inserted properly. The batteries inside the remote control are dead. The remote control is operated from an incorrect distance or angle. 	<ul style="list-style-type: none"> Insert properly. Replace the batteries. Operate it within a range of 8" (0.2 m) to 20' (6 m) and within an angle of 15° to either side of center.
<ul style="list-style-type: none"> The power cannot be turned on from the remote control. 	<ul style="list-style-type: none"> Is the AC power cord plugged in? 	<ul style="list-style-type: none"> Connect the AC power cord.

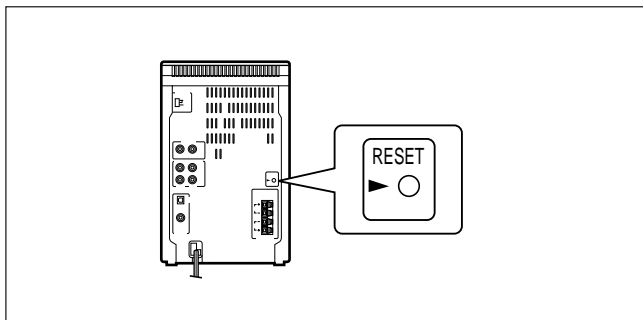

■ If a problem occurs

If this product is subjected to strong external interference (mechanical shock, excessive static electricity, abnormal supply voltage due to lightning, etc.) or if it is operated incorrectly, it may malfunction or the display may not function correctly. If such a problem occurs, do the following:

- 1 Unplug the AC power cord from the AC outlet.
 - 2 Press the RESET button on the back of the unit for at least 3 seconds.
 - 3 Plug the AC power cord back into the AC outlet.
- When the RESET button is pressed, all of the settings in memory will be erased.
 - If strange sounds, smells or smoke come out of the unit, or if a foreign object falls into the unit, turn off the power, unplug the AC power cord from the AC outlet immediately. Contact an authorized Sharp Servicer.



(Continued)

When an error message is displayed, proceed as follows:

Error messages	Meaning	Remedy
BLANK MD	<ul style="list-style-type: none"> Nothing is recorded. (Neither music nor a disc name have been recorded on this MD.) 	<ul style="list-style-type: none"> Replace the disc with a recorded disc.
Can't COPY	<ul style="list-style-type: none"> You tried to record from a disc which you are not allowed to copy. 	<ul style="list-style-type: none"> Replace it with another disc which you can copy from (regular CD).
Can't EDIT	<ul style="list-style-type: none"> A track cannot be edited. 	<ul style="list-style-type: none"> Change the stop position of the track and then try editing it.
Can't REC	<ul style="list-style-type: none"> Recording cannot be performed correctly due to vibration or shock in the unit. 	<ul style="list-style-type: none"> Rerecord or replace it.
DEFECT	<ul style="list-style-type: none"> Since this disc has scratches on it, the recording operation was skipped. 	<ul style="list-style-type: none"> Replace the disc with another recordable disc.
Din UNLOCK	<ul style="list-style-type: none"> Incorrect digital signals are input. 	<ul style="list-style-type: none"> Connect correct digital signals. Use analog inputs.
DISC ERR*	<ul style="list-style-type: none"> The disc is damaged or there is no TOC on the disc. 	<ul style="list-style-type: none"> Reload the disc or replace it.
DISC FULL	<ul style="list-style-type: none"> The disc is out of recording space. 	<ul style="list-style-type: none"> Replace the disc with another recordable disc.
EDIT OVER	<ul style="list-style-type: none"> There is no space left for recording CD. 	<ul style="list-style-type: none"> Replace it with another recordable disc.
FOCUS ERROR	<ul style="list-style-type: none"> The proper focus cannot be obtained. 	<ul style="list-style-type: none"> Reload the disc.
MD ERROR	<ul style="list-style-type: none"> The unit has determined that it is out of order by performing a self-diagnosis. 	<ul style="list-style-type: none"> Ask the store where you purchased this unit, about repairs.
MECHA ERR*	<ul style="list-style-type: none"> There is a mechanical problem and the disc is not working properly. 	<ul style="list-style-type: none"> Turn off the power, and press the EJECT button.
NAME FULL	<ul style="list-style-type: none"> The number of characters for the disc name or track name exceeds 100. 	<ul style="list-style-type: none"> Shorten the disc or track name.
NO DISC	<ul style="list-style-type: none"> A disc has not been loaded. The disc data cannot be read. 	<ul style="list-style-type: none"> Load a disc. Reload the disc.
NOT AUDIO	<ul style="list-style-type: none"> The data recorded on this disc is not audio data. 	<ul style="list-style-type: none"> Select another track. Replace the disc.
PLAYBACK MD	<ul style="list-style-type: none"> You tried to record on a playback-only disc. 	<ul style="list-style-type: none"> Replace it with a recordable disc.
PROTECT	<ul style="list-style-type: none"> The unit has determined that it is out of order by performing a self-diagnosis. 	<ul style="list-style-type: none"> Turn the power off and back on. If the problem is not resolved, ask the store where you purchased this unit, about repairs.
PROTECTED	<ul style="list-style-type: none"> The disc is write protected. 	<ul style="list-style-type: none"> Move the write protection tab back to its original position.
TEMP OVER	<ul style="list-style-type: none"> The temperature is too high. 	<ul style="list-style-type: none"> Turn off the power, and wait for a while.
TOC ERR*	<ul style="list-style-type: none"> The disc has a large amount of damage. TOC information cannot be read. The MD does not meet the specifications for MDs. 	<ul style="list-style-type: none"> Replace the disc with another disc.
TOC FULL*	<ul style="list-style-type: none"> There is no space left for recording character information (track names, disc names, etc.). 	<ul style="list-style-type: none"> Replace it with another recordable disc.
TOC W ERROR	<ul style="list-style-type: none"> The unit has determined that it is abnormal by performing a self-diagnosis. 	<ul style="list-style-type: none"> Ask the store where you purchased this unit, about repairs.
U TOC ERR*	<ul style="list-style-type: none"> The TOC information on this disc does not meet the MD specifications or it cannot be read. 	<ul style="list-style-type: none"> Replace it with another disc. Erase all the data, and try recording.
U TOC W ERROR	<ul style="list-style-type: none"> The TOC information could not be created properly due to a mechanical shock or to scratches on the disc. 	<ul style="list-style-type: none"> Turn off the power, and try to write the TOC again. (Remove any source of shock or vibration while writing.)
? DISC	<ul style="list-style-type: none"> The data contains an error. 	<ul style="list-style-type: none"> Replace the disc with another disc.
0 00:00	<ul style="list-style-type: none"> Music is not recorded. 	<ul style="list-style-type: none"> Replace the disc with a recorded disc.

*: Number or symbol



MAINTENANCE

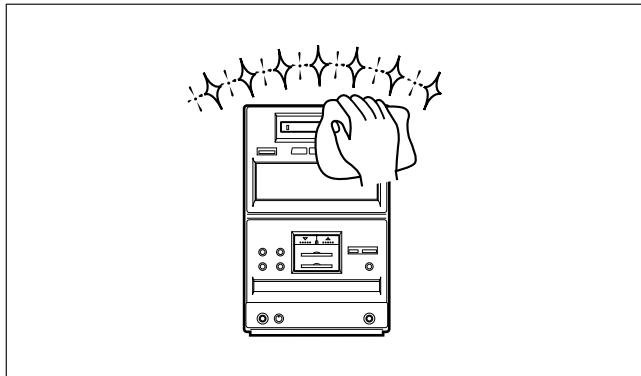

Internal care

- In order to ensure proper operation of the CD player, preventative maintenance (cleaning of the Laser Pick-up lens) should be performed periodically in order to keep the lens dust-free. Lens cleaners are commercially available. Contact your local CD software dealer for options.

External care

- Periodically wipe the cabinet with a soft cloth and dilute soap solution, then wipe with a dry cloth.
- Do not use chemically treated cleaning cloths or other chemicals.

SPECIFICATIONS

As a part of our policy of continuous improvement, SHARP reserves the right to make design and specification changes for product improvement without prior notice. The performance specification figures indicated are nominal values of production units. There may be some deviations from these values in individual units.

Main unit section

(MiniDisc recorder section)

Type:	MiniDisc recorder
Signal readout:	Non-contact, 3-beam semi-conductor laser pick-up
Audio channel:	Stereo; 2 channel Monaural; 1 channel (long-time recording mode)
Frequency response:	20 - 20,000 Hz
Rotational speed:	400 - 900 rpm CLV, Approx.
Quantization:	16-bit linear
Filter:	8-times oversampling digital filter
Error correction:	ACIRC (Advanced Cross Interleave Reed-Solomon Code)
Coding:	ATRAC (Adaptive TRansformd Acoustic Coding)
Recording method:	Magnetic modulation overwrite method
D/A converter:	1-bit
Sampling frequency:	44.1 kHz
Wow and flutter:	Unmeasurable (less than 0.001% W. peak)
Signal/noise ratio:	95 dB (1 kHz)
Dynamic range:	90 dB (1 kHz)
T.H.D at 1kHz:	0.1%

(Compact disc player)

Type:	Compact disc player
Signal readout:	Non-contact, 3-beam semi-conductor laser pickup
Rotational speed:	200 - 500 rpm CLV, Approx.
Error correction:	CIRC (Cross Interleave Reed-Solomon Code)
Quantization:	16-bit linear
D/A converter:	1-bit
Filter:	4-times oversampling digital filter
Frequency response:	20 - 20,000 Hz
Signal/noise ratio:	95 dB (1 kHz)
Dynamic range:	90 dB (1 kHz)
Wow and flutter:	Unmeasurable (less than 0.001% W. peak)

(Tuner section)

Frequency range:	FM; 87.5 - 108 MHz AM; 530 - 1,720 kHz
Sensitivity:	FM; 8.0 μ V (75 ohms, unbalanced) AM; 650 μ V/m

(General)

Power source:	AC 120 V, 60 Hz
Power consumption:	80 W
Output power:	10 watts minimum RMS per channel into 6 ohms from 60 Hz to 20 kHz, 10 % total harmonic distortion
Input terminals:	Auxiliary (Analog); 2.0 V (30 kohms) Auxiliary (Digital-1) Auxiliary (Digital-2) Phono; 2.5 mV (47 kohm)
Output terminals:	Headphones; 16- 50 ohms (recommended; 32 ohms) Speakers; 6 ohms Line out (Analog); 2.0 V (47 kohm)
Dimensions:	Width; 5-15/16" (150 mm) Height; 9-1/2" (241 mm) Depth; 12-1/8" (307 mm)
Weight:	9.5 lbs. (4.3 kg)

Speaker section

Type:	2-way 4-3/4" (120 mm) woofer and 2" (50 mm) tweeter type
Maximum input power:	25 W
Rated input power:	12.5 W
Impedance:	6 ohms
Dimensions:	Width; 5-3/4" (146 mm) Height; 9-1/2" (241 mm) Depth; 9-1/8" (229 mm)
Weight:	4.9 lbs. (2.2 kg)/each



MEMO





CALLING FOR SERVICE

For location of the nearest Sharp Authorized Service, or to obtain product literature, accessories, supplies or customer assistance, please call **1-800-BE SHARP**.

LIMITED WARRANTY

SHARP ELECTRONICS CORPORATION warrants to the first consumer purchaser that this Sharp brand product (the "Product"), when shipped in its original container, will be free from defective workmanship and materials, and agrees that it will at its option, either repair the defect or replace the defective Product or part thereof with a new or remanufactured equivalent at no charge to the purchaser for parts or labor for the period(s) set forth below.

This warranty does not apply to any appearance items of the Product nor to the additional excluded item(s) set forth below nor to any Product the exterior of which has been damaged or defaced, which has been subjected to misuse, abnormal service or handling, or which has been altered or modified in design or construction.

In order to enforce the rights under this limited warranty, the purchaser should follow the steps set forth below and provide proof of purchase to the servicer.

The limited warranty described above is in addition to whatever implied warranties may be granted to purchasers by law. ALL IMPLIED WARRANTIES INCLUDING THE WARRANTIES OF MERCHANTABILITY AND FITNESS FOR USE ARE LIMITED TO THE PERIOD(S) FROM THE DATE OF PURCHASE SET FORTH BELOW. Some states do not allow limitations on how long an implied warranty lasts, so the above limitation may not apply to you.

Neither the sales personnel of the seller nor any other person is authorized to make any warranties other than those described above, or extend the duration of any warranties beyond the time period described below on behalf of Sharp.

The warranties described above shall be the sole and exclusive warranties granted by Sharp and shall be the sole and exclusive remedy available to the purchaser. Correction of defects, in the manner and for the period of time described herein, shall constitute complete fulfillment of all liabilities and responsibilities of Sharp to the purchaser with respect to the Product, and shall constitute full satisfaction of all claims, whether based on contract, negligence, strict liability or otherwise. In no event shall Sharp be liable, or in any way responsible, for any damages or defects in the Product which were caused by repairs or attempted repairs performed by anyone other than an authorized servicer. Nor shall Sharp be liable or in any way responsible for any incidental or consequential economic or property damage. Some states do not allow the exclusion of incidental or consequential damages, so the above exclusion may not apply to you. THIS WARRANTY GIVES YOU SPECIFIC LEGAL RIGHTS. YOU MAY ALSO HAVE OTHER RIGHTS WHICH VARY FROM STATE TO STATE.

Product Model Number: See your product for specific model number and have it available when requesting service for your Product.

Warranty Period for this Product: 1 year parts and labor from the date of purchase.

Excluded from Warranty Coverage: non-functional accessories, supplies and consumable items.

How to Obtain Service: Contact a Servicer. To find the location of the nearest authorized Servicer, call Sharp toll free at 1-800-BE SHARP. Then, ship prepaid or carry in your Product with proof of purchase to the Servicer. If you ship the Product, be sure it is insured and packaged securely.

SHARP ELECTRONICS CORPORATION
Sharp Plaza, Mahwah, New Jersey 07430-2135

SHARP

SHARP ELECTRONICS CORPORATION
Sharp Plaza, Mahwah, New Jersey 07430-2135

SHARP CORPORATION

TINSE0185AWZZ

Printed in Malaysia
B9709.SM