

SHARP

MD/CD COMPONENT SYSTEM

MODEL

MD-X3H

OPERATION MANUAL

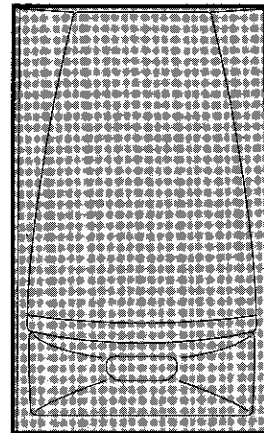
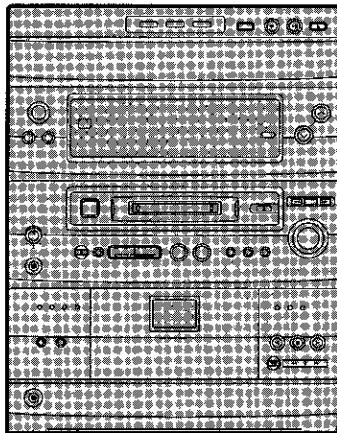
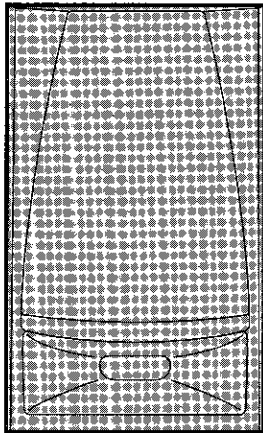

MD-X3H MD/CD component system consisting of
MD-X3H MD/CD component system
CP-X3H speaker system.



COMPACT
disc
DIGITAL AUDIO

SPECIAL NOTES

NOTE FOR USERS IN THE U.K.

The mains lead of this product is fitted with a non-rewireable (moulded) plug incorporating a 3A fuse. Should the fuse need to be replaced, a BSI or ASTA approved BS 1362 fuse marked  or  and of the same rating as above, which is also indicated on the pin face of the plug must be used.

Always refit the fuse cover after replacing the fuse. Never use the plug without the fuse cover fitted.

In the unlikely event of the socket outlet in your home not being compatible with the plug supplied, cut-off the mains plug and fit an appropriate type.

DANGER:

The fuse from the cut-off plug should be removed and the cut-off plug destroyed immediately and disposed of in a safe manner.

Under no circumstances should the cut-off plug be inserted elsewhere into a 13A socket outlet as a serious electric shock may occur.

To fit an appropriate plug to the mains lead, follow the instructions below:

IMPORTANT:

The wires in the mains lead are coloured in accordance with the following code:

Blue : Neutral
Brown : Live

As the colours of the wires in the mains lead of this product may not correspond with the coloured markings identifying the terminals in your plug, proceed as follows:

- The wire which is coloured blue must be connected to the plug terminal which is marked N or coloured black.
- The wire which is coloured brown must be connected to the plug terminal which is marked L or coloured red.

Ensure that neither the brown nor the blue wire is connected to the earth terminal in your three pin plug.

Before replacing the plug cover, make sure that:

- If the new fitted plug contains a fuse, its value is the same as that removed from the cut-off plug.
- The cord grip is clamped over the sheath of the mains lead and not simply over the lead wires.

IF YOU HAVE ANY DOUBT, CONSULT A QUALIFIED ELECTRICIAN.

SERVICE INFORMATION

In the unlikely event of your equipment requiring repair, please contact the dealer or supplier from whom it was purchased. Where this is not possible, please contact the telephone number listed below. You will then be given details of how to obtain service.

0345-125387

Please note; all calls will be charged at local rate.

Certain replacement parts and accessories may be obtained from our main parts distributor, who can be contacted on the following numbers;
WILLOW VALE ELECTRONICS LTD.

MANCHESTER 0161-682-1415
READING 01734-876444

In the unlikely event of this equipment requiring repair during the guarantee period, you will need to provide proof of the date of purchase to the repairing company. Please keep your invoice or receipt, which is supplied at the time of purchase.

- Recording and playback of any material may require consent, which SHARP is unable to give. Please refer particularly to the provisions of the Copyright Act 1956, the Dramatic and Musical Performers Protection Act 1958, the Performers Protection Acts 1963 and 1972 and to any subsequent statutory enactments and orders.
- This equipment complies with the requirements of Directives 89/336/EEC and 73/23/EEC as amended by 93/68/EEC.
- SRS technology Licensed from SRS Labs. SRS technology holds the following patents: U.S. Patent No. 4,748,669 and U.S. Patent No. 4,841,572.
- **SRS**, the SRS Logo  and the **SOUND RETRIEVAL SYSTEM** are registered trademarks of SRS Labs, Inc. in the United States.



- Dolby noise reduction manufactured under license from Dolby Laboratories Licensing Corporation.
- "DOLBY" and the double-D symbol  are trademarks of Dolby Laboratories Licensing Corporation.

Us and foreign patents licensed from Dolby Laboratories Licensing Corporation.

- When the POWER switch is set at STAND-BY position mains voltage is still present inside the unit.

When the POWER switch is set at STAND-BY position and the clock is displayed, the unit may be brought into operation by use of (timer mode or) remote control.

Warning:

This unit contains no user serviceable parts. Never remove covers unless qualified to do so. This unit contains dangerous voltages, always remove mains plug from the socket before any service operation and when not in use for a long period.

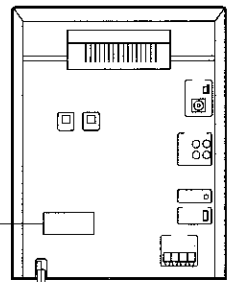
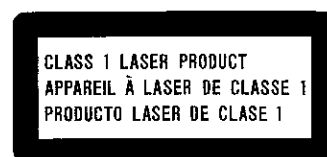

Caution:

Use the MD/CD component system only in accordance with the instructions given in this manual and do not attempt to interfere with the interlock switch or make any other adjustment as this may result in exposure to hazardous radiation.





INTRODUCTION

Thank you for purchasing this SHARP product.
For the best performance, read this manual carefully. It will guide you in operating your SHARP product.

CONTENTS

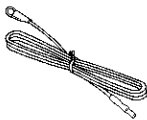
	Page		Page
ACCESSORIES	2	VARIOUS OPERATIONS	17 - 19
PRECAUTIONS	2	BASIC INFORMATION ON MINIDISCS	20 - 21
NAMES OF CONTROLS AND INDICATORS	3 - 4	RECORDING	22 - 25
REMOTE CONTROL	5	EDITING	26 - 33
PREPARATION FOR USE	6 - 7	HOW TO USE THE BUILT-IN TIMER	34 - 37
SETTING THE CLOCK	8	USING EXTERNAL UNITS	38 - 39
SOUND CONTROL	9 - 10	WHAT IS A MINIDISC?	40 - 41
COMPACT DISC OPERATION	11 - 12	MINIDISC SYSTEM LIMITATIONS	41
MINIDISC OPERATION	13	TROUBLE SHOOTING	42 - 44
CASSETTE OPERATION	14 - 15	MAINTENANCE	45
RADIO OPERATION	16	SPECIFICATIONS	45

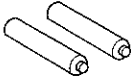
ACCESSORIES

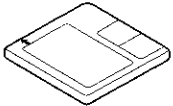
					
FM aerial × 1	AM loop aerial × 1	Remote control × 1	“AA” size battery (UM/SUM-3, R6, HP-7 or similar) × 2	Speaker Wire × 2	Blank (Recordable) MiniDisc (60 minutes recording length) × 1

Note:

Parts and equipment mentioned in this operation manual other than those shown above are not included.

PRECAUTIONS

General

- Please ensure that the equipment is positioned in a well ventilated area and ensure that there is at least 5 cm of free space along the sides, top and back of the equipment.
- Do not use oil, solvents, petrol, paint thinner or insecticides on the unit.
- Do not expose the unit to moisture, to temperatures higher than 60°C (140°F) or to extreme low temperatures.
- Keep the unit away from direct sunlight, strong magnetic fields, excessive dust, humidity and electronic/electrical equipment (home computers, facsimiles, etc.) which generates electrical noise.
- Hold the AC power plug by the head when removing it from the AC socket, since pulling the lead can damage internal wires.
- Remove the AC power plug from the wall socket before cleaning the heads, pinch rollers, etc.
This unit contains dangerous voltages.
Do not remove the outer cover, as this may result in electric shock.
Refer internal service to your local SHARP service facility.
- Use the unit on a firm, level surface free from vibration, and do not place anything on the top of the unit.
- If the unit does not work properly whilst in use, set the POWER switch to STAND-BY, then disconnect the AC power lead from the AC socket. Plug the AC power lead back in, and then press the POWER switch to ON.
- If a lightning storm is taking place near you, it is suggested that you disconnect the AC power lead from the AC socket for safety.

Warning:

The voltage used must be the same as that specified on this unit. Using this product with a higher voltage than that which is specified is dangerous and may result in a fire or other type of accident causing damage. SHARP will not be held responsible for any damage resulting from use of this unit with a voltage other than that which is specified.

Volume control

The sound level at a given volume setting depends on a combination of speaker efficiency, location and many other factors. It is advisable to avoid exposure to high volume levels, which occur whilst turning the unit on with the volume control setting up high, or whilst continually listening at high volumes.

Condensation

Sudden temperature changes and storage or operation in an extremely humid environment may cause condensation inside the cabinet. Condensation can cause the unit to malfunction. Follow the procedure below to eliminate condensation.

CD pickup

Leave the power on with no disc in the unit until normal playback is possible (about 1 hour).

Tape head

Leave the power on with no cassette in the unit until normal playback is possible (about 1 hour).

Note:

If condensation forms on the tape head, foreign matter may accumulate on it during use.

Remote control

Wipe off any condensation on the transmitter window with a soft cloth before operating the unit.

NAMES OF CONTROLS AND INDICATORS

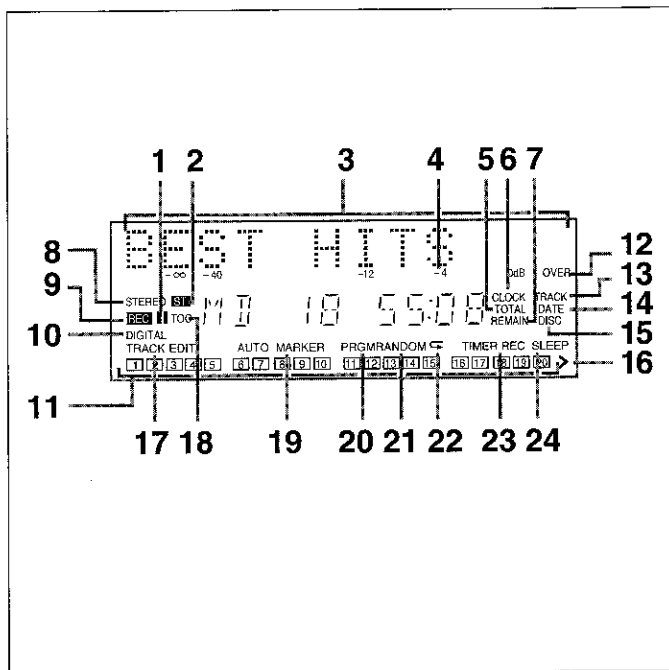

- Display window
- 1. MD Pause Indicator: **||**
- 2. FM Stereo Indicator: **ST**
- 3. Level Meter/Character Information Display
- 4. Recording Level Indicator
- 5. Total Time Indicator
- 6. Clock Indicator
- 7. Remaining Time Indicator
- 8. FM Stereo Mode Indicator
- 9. MD Record Indicator: **REC**
- 10. Digital/Digital Edit Indicator
- 11. Music Schedule/Preset Number Indicators
- 12. Recording Level Too High Indicator
- 13. Track Name Indicator
- 14. Date Indicator
- 15. Disc Name Indicator
- 16. More Tracks Indicator
- 17. Track Editing Indicator
- 18. MD TOC Indicator
- 19. Auto Mark Indicator
- 20. Programme Indicator
- 21. Random Play Indicator
- 22. Repeat Indicator: **⏮**
- 23. Timer/Timer Record Indicator
- 24. Sleep Indicator

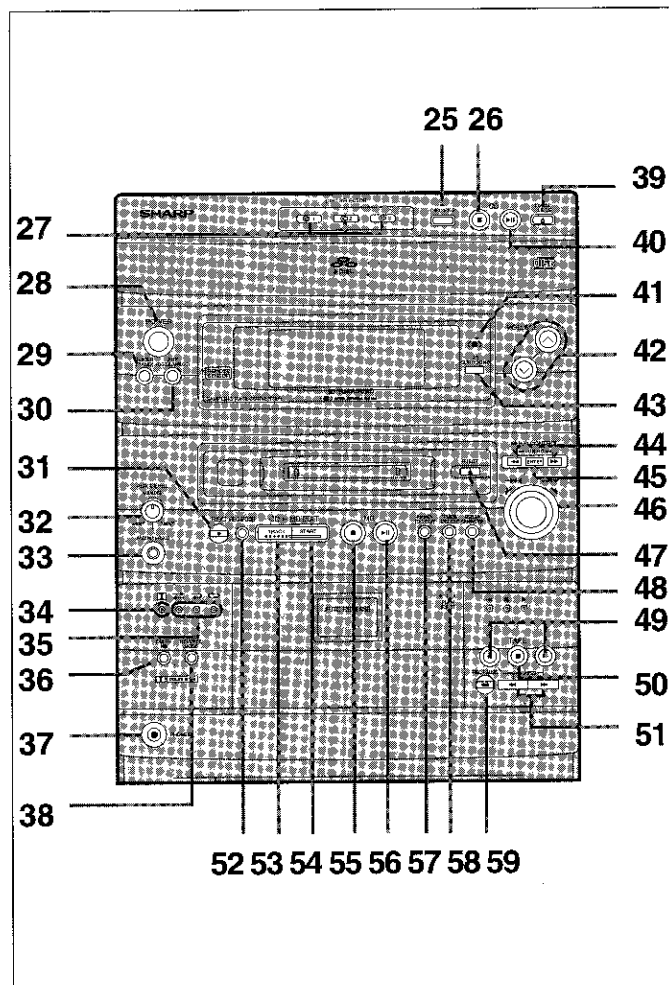

- Front panel
- 25. CD Disc Skip Button
- 26. CD Stop Button: **■**
- 27. CD Disc Select Buttons
- 28. Power Switch
- 29. Tuner Call (Band Select) Button
- 30. Auxiliary Input (Digital/Analogue) Select Button
- 31. MD Record Button: **●**
- 32. Auxiliary Level (Analogue) Control
- 33. Auxiliary (Stereo) Socket
- 34. Dolby NR Indicator
- 35. Tape Direction Indicators
- 36. Dolby NR Button
- 37. Headphones Socket
- 38. Reverse Mode Button
- 39. CD Open/Close Button: **▲**
- 40. CD Play/Pause Button: **▶||**
- 41. 3D Surround Indicator
- 42. Volume Up/Down Buttons: **∨/∧**
- 43. 3D Surround Button
- 44. Tuning Up/Down, CD Cue/Review Buttons: **◀/▶**
- 45. Enter Button
- 46. Jog Dial
- 47. MD Eject Button: **▲**
- 48. Display/Character Button
- 49. Tape Reverse Play Button: **◀**
- 49. Tape Forward Play Button: **▶**
- 50. Tape Stop Button: **■**
- 51. Tape Fast Wind Buttons: **◀◀/▶▶**
- 52. MD Record Mode Select Button
- 53. CD Track Select Button
- 54. CD Edit Button
- 55. MD Stop Button: **■**
- 56. MD Play/Pause Button: **▶||**
- 57. Name TOC-Edit Button
- 58. Timer/Delete Button
- 59. Tape Record/Pause Button: **●||**

(Continued)

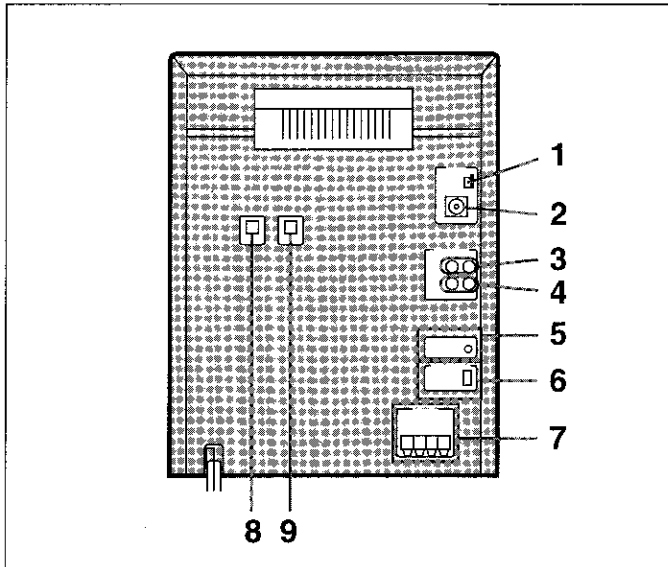

● Rear panel

1. AM Loop Aerial Input Socket
2. FM 75 ohms Aerial Socket
3. Analogue Output Sockets
4. Analogue Input Sockets
5. Reset Button
6. Beat Cancel Switch
7. Speaker Terminals
8. Digital Output Socket
9. Digital Input Socket

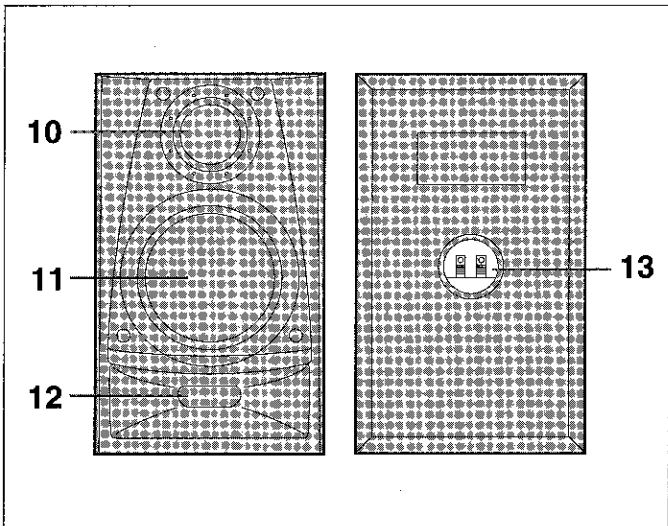

● Speaker section

10. Tweeter
11. Woofer
12. Bass Reflex Duct
13. Speaker Terminals

REMOTE CONTROL

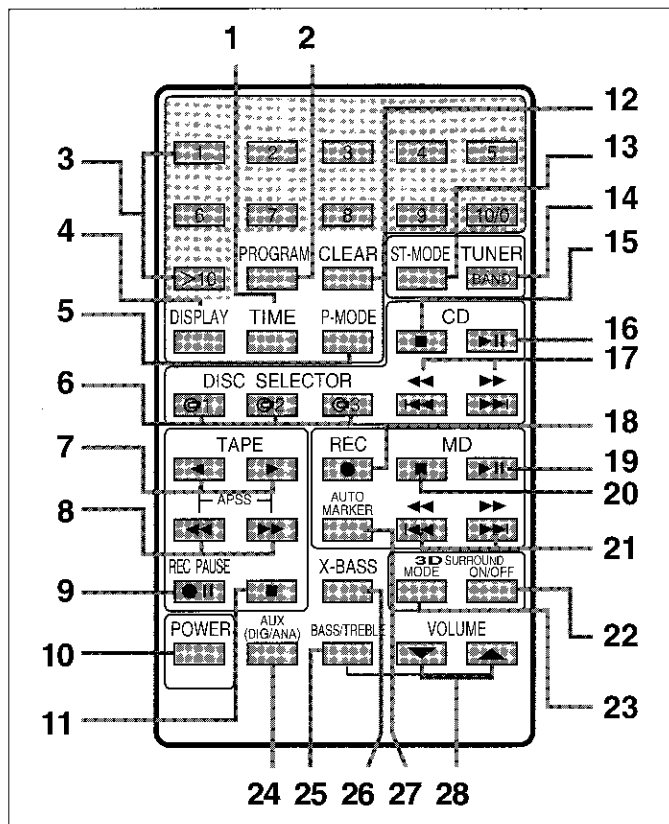

Names of controls

1. Time Display Select Button
2. Programme Button
3. Tuner Preset/CD/MD Track Number Input Buttons
4. Display Button
5. Play Mode Button
6. CD Disc Select Buttons
7. Tape Reverse Play Button: ◀
Tape Forward Play Button: ▶
8. Fast Wind/APSS Buttons: ◀◀ / ▶▶
9. Tape Record/Pause Button: ●||
10. Power Button
11. Tape Stop Button: ■
12. Clear Button
13. FM Stereo Mode Button
14. Tuner Call (Band Select) Button
15. CD Stop Button: ■
16. CD Play/Pause Button: ▶||
17. CD Track Up/Down, Cue/Review Buttons: ◀◀ / ▶▶, ◀ / ▶
18. MD Record Button: ●
19. MD Play/Pause Button: ▶||
20. MD Stop Button: ■
21. MD Track Up/Down, Cue/Review Buttons: ◀◀ / ▶▶, ◀ / ▶
22. 3D Surround On/Off Button
23. 3D Surround Mode Select Button
24. Auxiliary (Digital/Analogue) Select Button
25. Bass/Treble Select Button
26. X-BASS Button
27. Auto Mark Button
28. Volume Buttons: ▼ / ▲

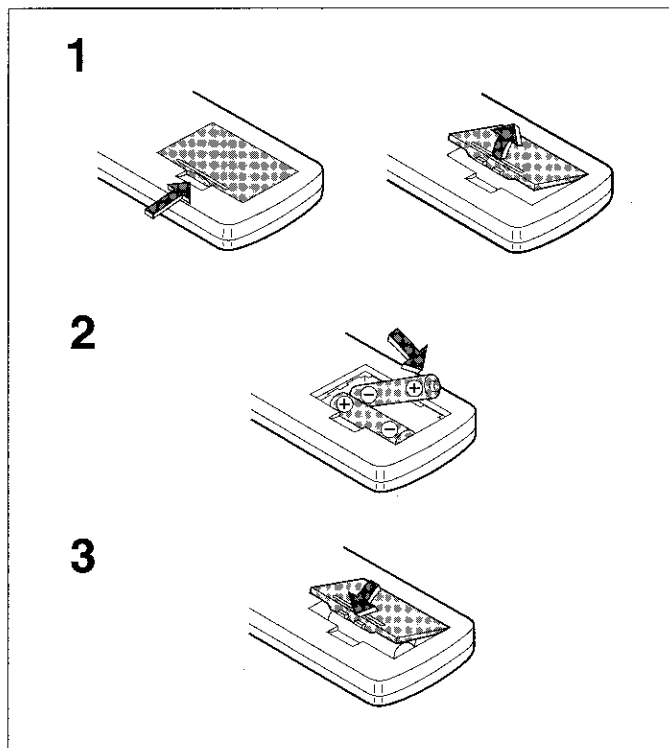

Loading the batteries for the remote control

- 1 Remove the battery compartment cover.
- 2 Insert 2 "AA" size batteries (UM/SUM-3, R6, HP-7 or similar) into the battery compartment.
 - When inserting the batteries, push them toward the ⊖ battery terminals.
 - Placing the batteries the wrong way round can cause the unit to malfunction.
- 3 Replace the battery compartment cover.

Battery removal:

- Push the batteries toward the ⊖ battery terminals and remove them.

Precautions for battery use:

- Insert the batteries according to the direction indicated in the battery compartment.
- Replace all old batteries with new ones at the same time.
- Remove the batteries if they are weak or if the unit is not in use for long periods to prevent potential damage due to battery leakage.
- Do not mix old and new batteries.

Caution:

Do not use rechargeable batteries (nickel cadmium battery, etc.).

Proper use of the remote control

Aim the remote control at the remote control sensor within 30°, with no obstacles, and operate as shown.

Notes concerning use:

- Replace the battery if control distance decreases or operation becomes erratic.
- Periodically clean the transmitter window on the remote control and the sensor on the main unit with a soft cloth.
- Exposing the sensor on the main unit to strong light may interfere with operation. Change the lighting or the direction of the unit.
- Keep the remote control away from moisture, excessive heat, shock, and vibrations.
- The remote control's usable range is between 0.2 m (8") and 6 m (20') away from the sensor.

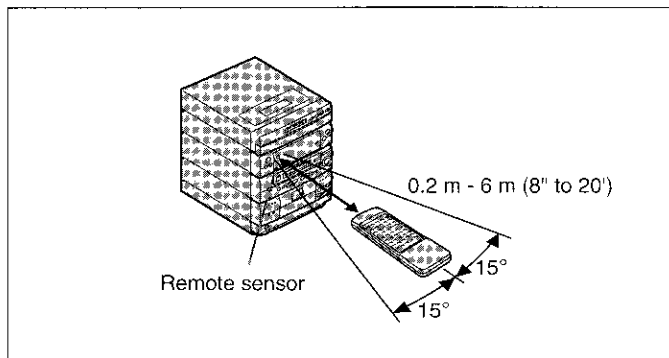

PREPARATION FOR USE

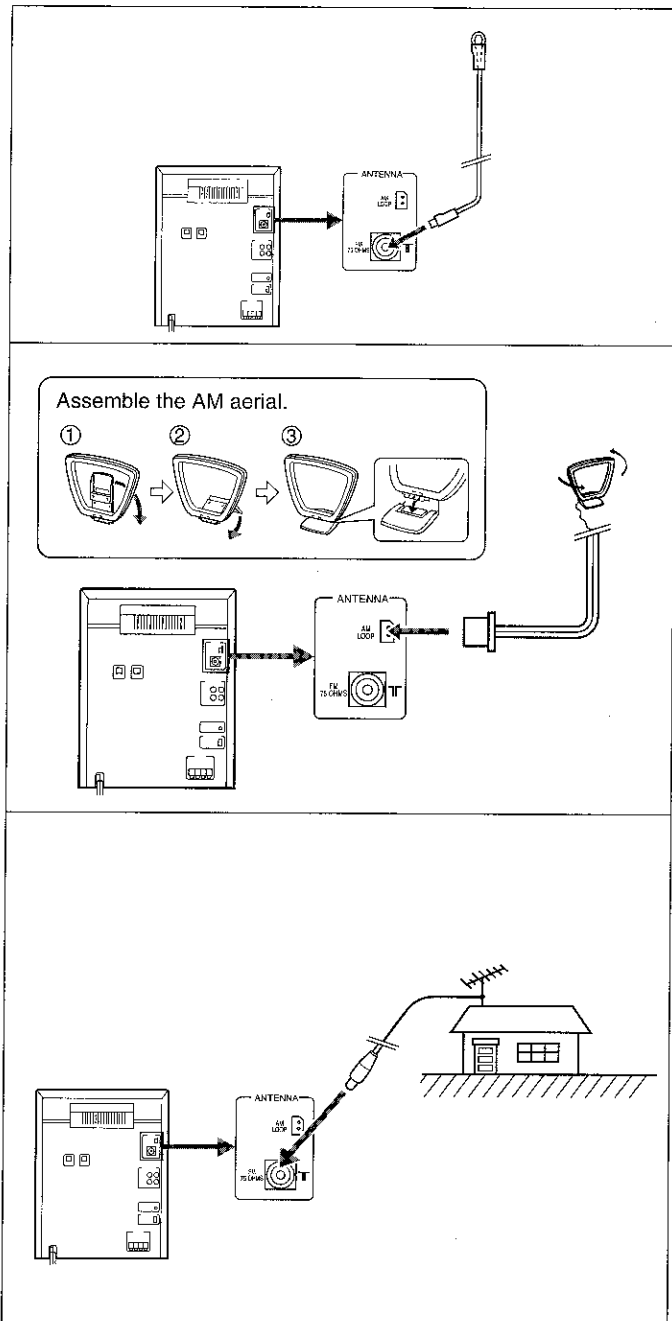

- Turn off the power before connecting or disconnecting any wire.

■ Aerial connection

(1) Supplied FM aerial

Connect the FM aerial wire to the FM 75 OHMS socket and position it in the direction where the strongest signal can be received.

(2) Supplied AM loop aerial

Connect the AM loop aerial wire to the AM LOOP socket. Position the AM loop aerial for optimum reception.

Place the AM loop aerial on a shelf, etc., or attach it to a stand or wall with screws (not supplied).

Notes:

- Do not place the AM loop aerial and the FM aerial wire on the unit. It may result in noise generation, since the unit is equipped with digital electronics. Place the AM loop aerial and the FM aerial wire away from the unit for better reception.
- If the AM loop aerial and the FM aerial wire are placed near the AC power lead, it may cause interference.

(3) External FM aerial

Use an external FM aerial if you need better reception. Consult your dealer.

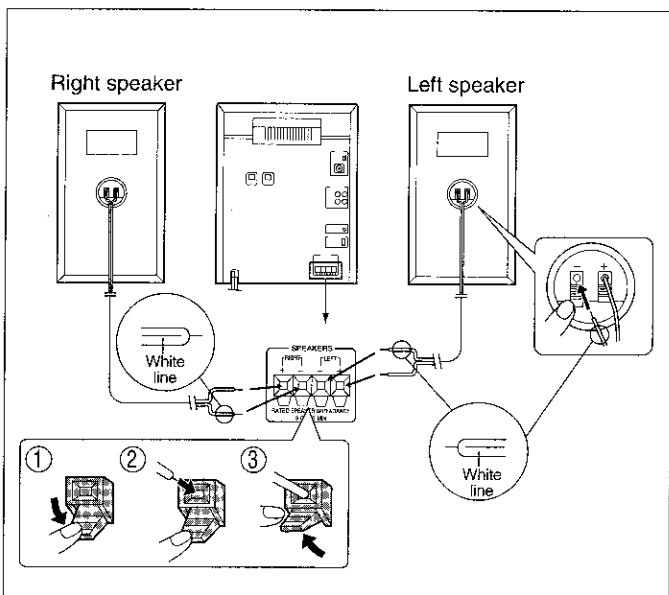

■ Speaker connection

- Before connecting the speaker wires, be sure to turn off the power.

Connect each speaker wire to the SPEAKER terminals as shown.

- Connect the wire with the line to the minus (-) terminal and the plain wire to the plus (+) terminal.

Cautions:

- Do not let the bare speaker wires touch each other as this may damage the amplifier and/or speakers.
- When connecting the speakers to the unit, connect the wires to the speakers first, and then to the terminals on the unit.
- When connecting the speakers to the unit, be sure to connect the speaker wires properly. Do not mistake the right channel for the left channel and the plus (+) terminal for the minus (-) terminal.
- Use these SPEAKER terminals for CP-X3H only, do not connect it to speakers other than CP-X3H.
- Do not allow any objects to fall into or to be placed in the bass reflex ducts.

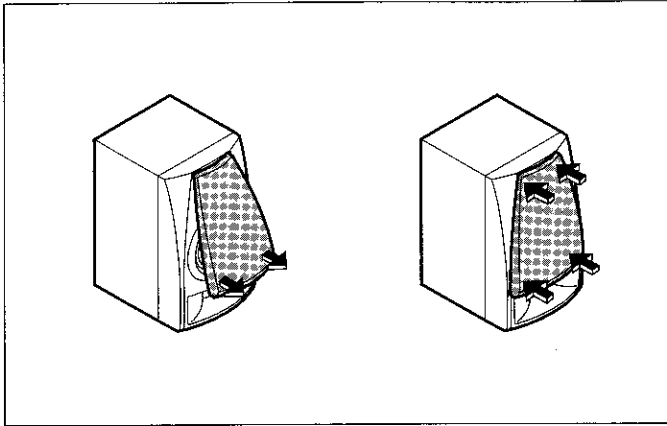

■ Removing the speaker grilles

- 1 Remove the lower part of the speaker grille first.
- 2 Remove the upper part of the speaker grille.

Caution:

When the speaker grilles are removed, the speaker diaphragms are exposed. Make sure nothing comes into contact with the speaker diaphragms.

■ Mounting the speaker grilles

Fit the four posts on the speaker grille into the mounting holes and push them lightly with the palm of your hand to secure.

■ Placing the system

- Be sure to keep the space between the units for ventilation.
- Keep the back and sides of this unit at least 5 cm away from the wall.
- If any kind of magnet or an electromagnet is placed too close to the TV set and the system, irregular colour may be seen.

TV set location

- Depending on the particular location of a TV set, colour variations may be seen on the TV screen. If this happens, move the system a little away from the TV and turn off the TV set. After 15 - 30 minutes, turn on the TV again.

The TV's own demagnetising function should eliminate the variations. However, if the colour still don't look right, move the system further away from the TV set.

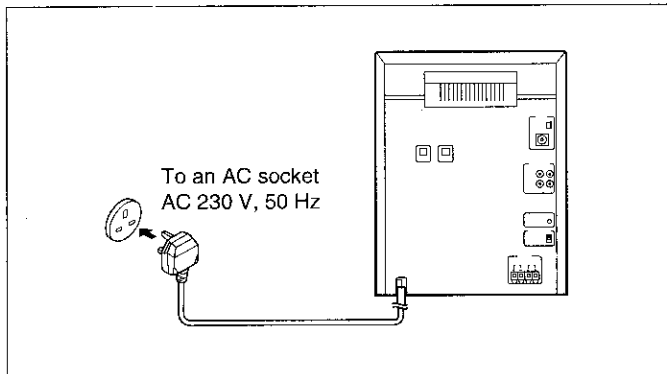
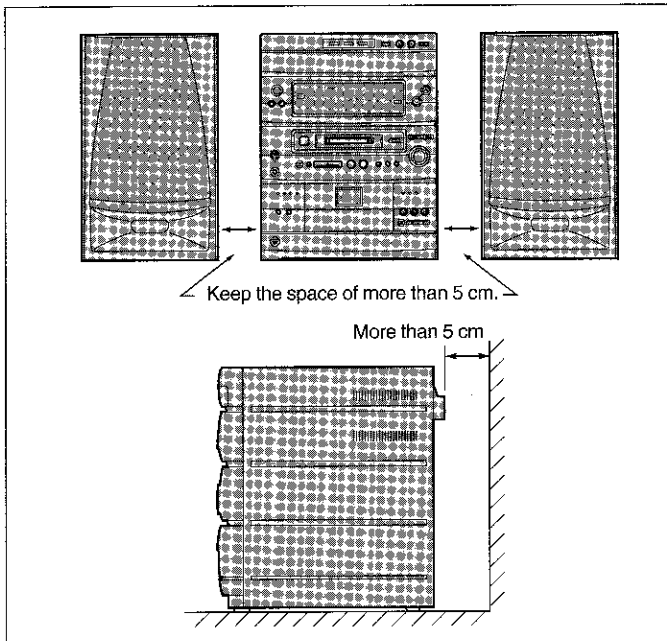

■ Connecting the AC power lead

- After connecting the speakers, plug the AC power lead into a convenient AC socket.
- Unplug the AC power lead from the AC socket if the unit is not to be used for a prolonged period of time.

Note:

- If the lead wires of a speaker wire are short-circuited when connecting a speaker with the power on, the protection circuit is activated and no sound is heard. Disconnect the AC power lead from the AC socket, and connect it again.

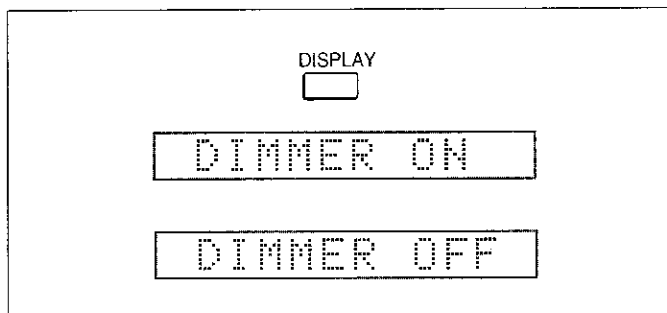

■ To change the brightness of the display

Turn the power on, and keep pressing the DISPLAY button for more than two seconds. The "DIMMER ON" display will appear, and the display will be dimmer.

To retrieve the original brightness, keep pressing the DISPLAY button for more than two seconds. The "DIMMER OFF" display will appear, and the original brightness is retrieved.

SETTING THE CLOCK

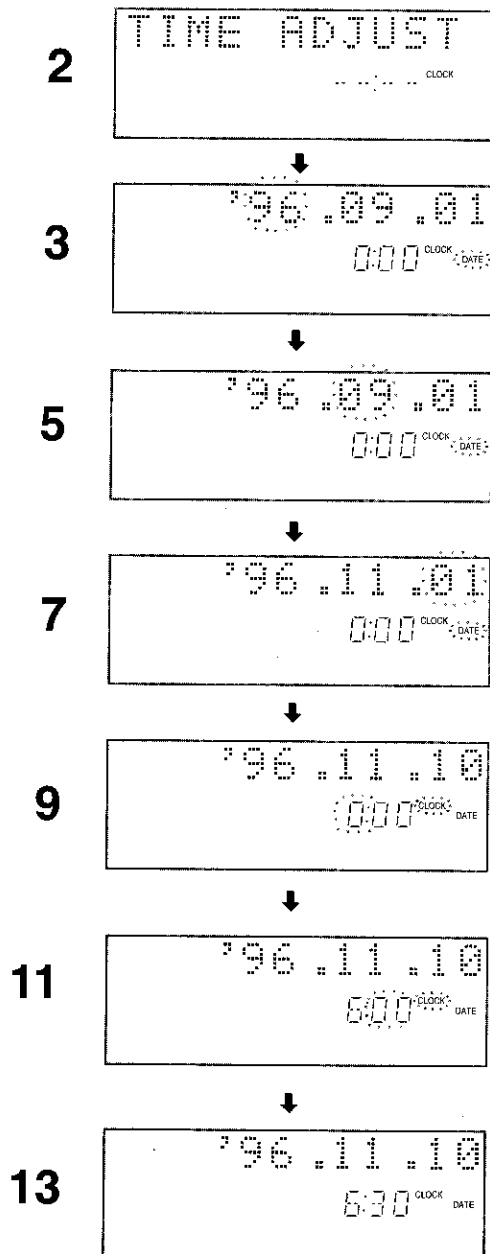
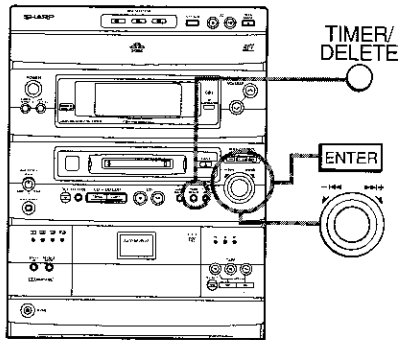

Main unit operation

- When the AC power lead is first connected, the clock indicator will display "TIME-ADJUST".
- 1 Turn the power on, and press the TIMER/DELETE button.
 - 2 Within 10 seconds, turn the jog dial until the TIME ADJUST display appears.
 - 3 Within 10 seconds, press the ENTER button.
 - The unit enters date setting mode.
 - 4 Adjust the year by turning the jog dial.
 - Turn the dial one click to advance the time by one year. Keep turning the dial to advance continuously.
 - For a year after 2000, set "00" for 2000, "01" for 2001 and so on.
 - 5 Press the ENTER button to set the year.
 - 6 Adjust the month by turning the jog dial.
 - 7 Press the ENTER button to set the month.
 - 8 Adjust the day by turning the jog dial.
 - 9 Press the ENTER button to set the date.
 - The unit enters time setting mode.
 - 10 Adjust the hour by turning the jog dial.
 - Turn the dial one click to advance the time by one hour. Keep turning the dial to advance continuously.
 - 11 Press the ENTER button to set the hour.
 - 12 Adjust the minute by turning the jog dial.
 - 13 Press the ENTER button to set the minute.
 - The clock starts operating.

Notes:

- In the event of a power failure or when the AC power lead is disconnected, the clock setting will be lost. Reset the time.
- Whilst recording an MD, you cannot set the date and clock. Be sure to set the date and clock before recording.

To change the setting

- Once you have set the date and time, "TIME ADJUST" will not be displayed in step 2. Turn the jog dial to make the date and time appear.
- If you don't need to change the settings, just press the ENTER button without turning the jog dial again.

To check the date and time

Press the TIMER/DELETE button, and turn the jog dial until the date and time appear.

SOUND CONTROL

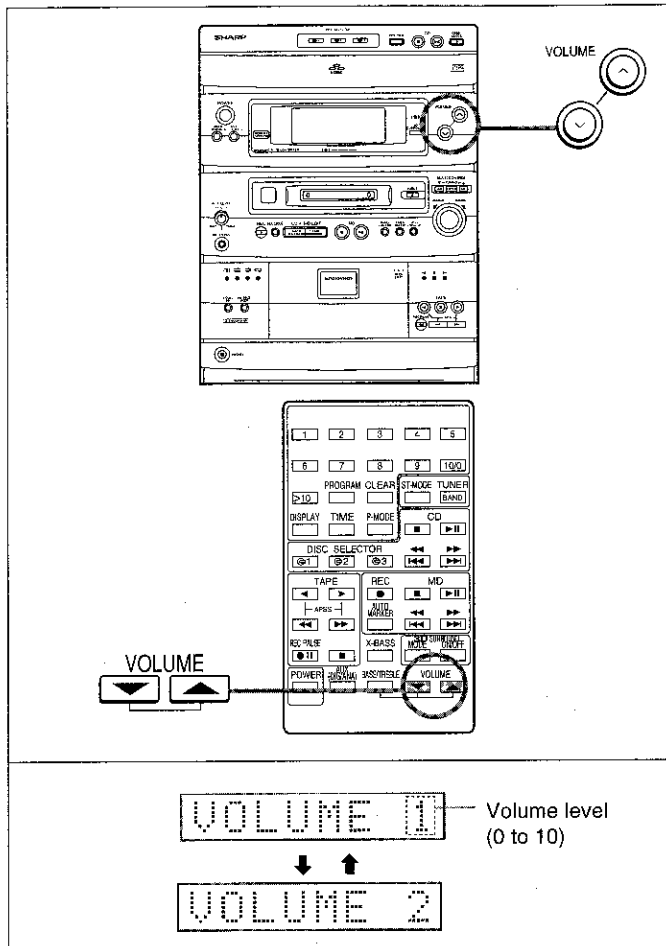

Volume

Main unit/remote control operation

Press the VOLUME \wedge button to increase the volume and the VOLUME \vee button to decrease the volume.

- The volume display can be changed within the range of "0" to "10".

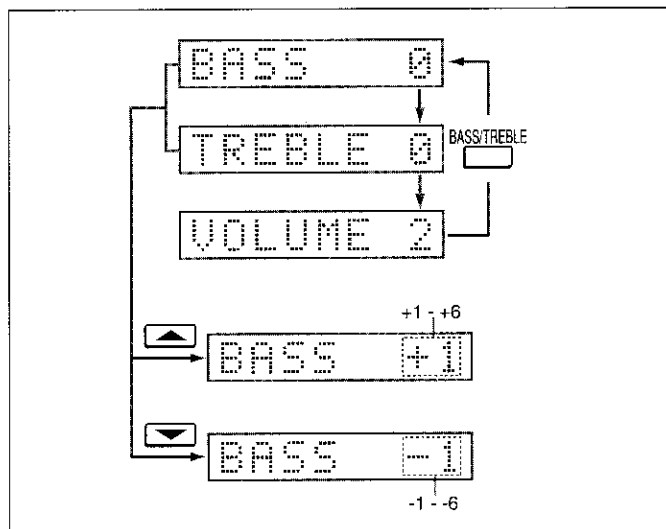

Treble

Remote control operation

Press the BASS/TREBLE button until the TREBLE display appears. Press the VOLUME \wedge button to increase the high-frequency level, and press the VOLUME \vee button to decrease the level.

Bass

Remote control operation

Press the BASS/TREBLE button until the BASS display appears. Press the VOLUME \wedge button to increase the low-frequency level, and press the VOLUME \vee button to decrease the level.

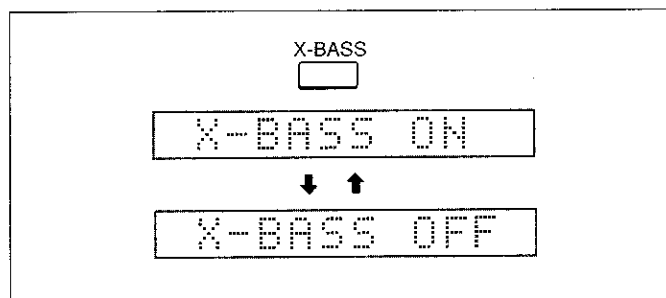

Extra bass (X-BASS)

Remote control operation

When this button is pressed once, the X-BASS display will appear, and the extremely low-frequency level is increased.

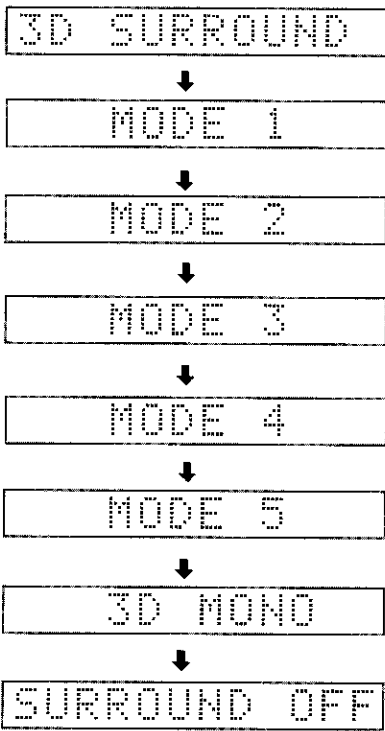
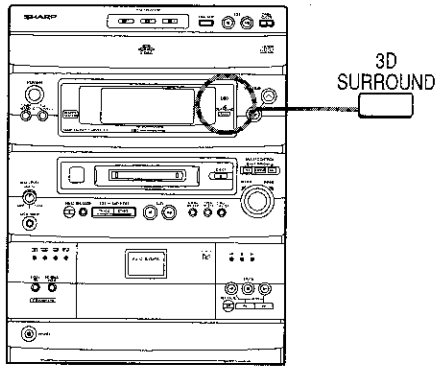

Ordinary stereo sound

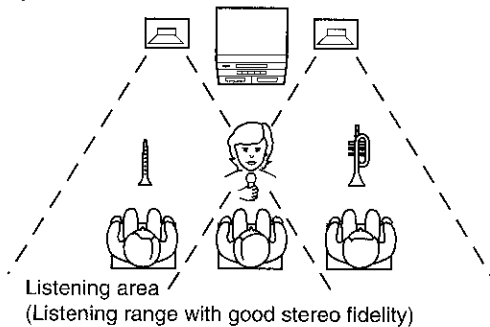

SRS (●) 3D surround

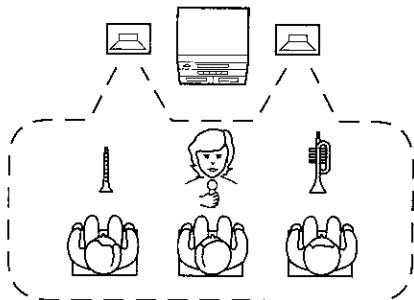

Wide listening area (Stereo music can be heard anywhere in the room.)

SRS (●) 3D SURROUND

About SRS (●) 3D surround:

SRS is a breakthrough technology that creates 3-dimensional sound by processing sound signals based on the human auditory system. It produces real depth and localization of the sound image which cannot be accomplished by ordinary stereo. SRS only requires two speakers.

SRS (●) 3D surround effects:

- Live performance atmosphere
(Simulates a live concert atmosphere)
- The localization of various musical source is quite clear.
(The positions of the musical instruments and singers are very clear.)
- Reproduction of depth
(Sounds from the front and back of an orchestra can be identified easily.)
- Expansion of the sound field
(The sound image is spread out over a wide area.)

When listening to a stereo sound source:

When the sound source is in stereo, you can select from any of 5 different 3D surround effect.

- 1 Select any desired audio source and begin playback.
 - 2 To hear the 3D surround effect, press the 3D SURROUND button.
- (●) will appear.

When the 3D SURROUND button on the main unit or the 3D SURROUND ON/OFF button on the remote control is pressed, the current mode setting will be displayed. To change to a different mode, press the 3D SURROUND MODE button on the remote control repeatedly.

MODE-1→MODE-2→MODE-3→MODE-4→MODE-5→3D MONO

SURROUND MODE	Effect from each mode
MODE-1	You will enjoy a sound image that produces an intimate soundfield (as in a medium-size hall).
MODE-2	This setting gives you a maximum soundfield, as music comes out beyond the speakers (as in a large, domed arena).
MODE-3	This setting is great for live recording and vocal music.
MODE-4	You will hear more vocals in an intimate soundfield (as at a live music performance).
MODE-5	This setting greatly increases the amount of vocals or centre sounds in a recording (as in a small club).
3D MONO	This setting produces 3D surround sound from a monaural sound source, for example a video game with monaural input.

To cancel the 3D surround effect

Press the 3D SURROUND button on the main unit or the 3D SURROUND ON/OFF button on the remote control until the "SURROUND OFF" display appears.

COMPACT DISC OPERATION

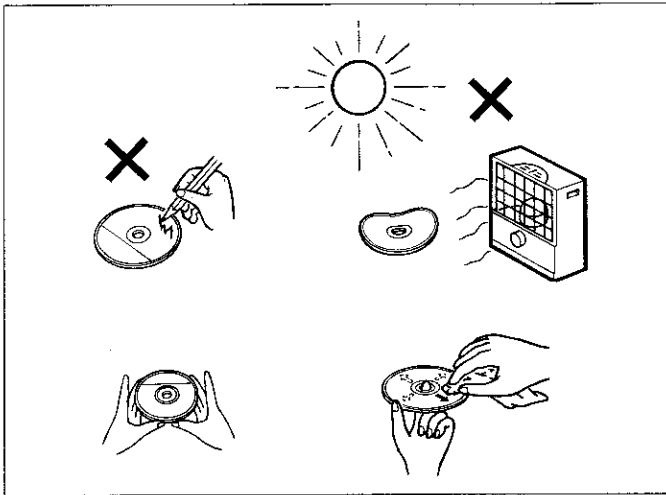

Care of compact discs

Compact discs are fairly resistant to damage, however mistracking can occur due to an accumulation of dirt on the disc surface. Follow the guidelines below for maximum enjoyment from your CD collection and player.

- Do not write on either side of the disc, particularly the non-label side. Signals are read from the non-label side. Do not mark on this surface.
- Keep your discs away from direct sunlight, heat, and excessive moisture.
- Always hold CDs by the edges. Fingerprints, dirt, or water on the CDs can cause noise or mistracking. If a CD is dirty or does not play properly, clean it with a soft, dry cloth, wiping straight out from the centre, along the radius.

Loading and playing CDs

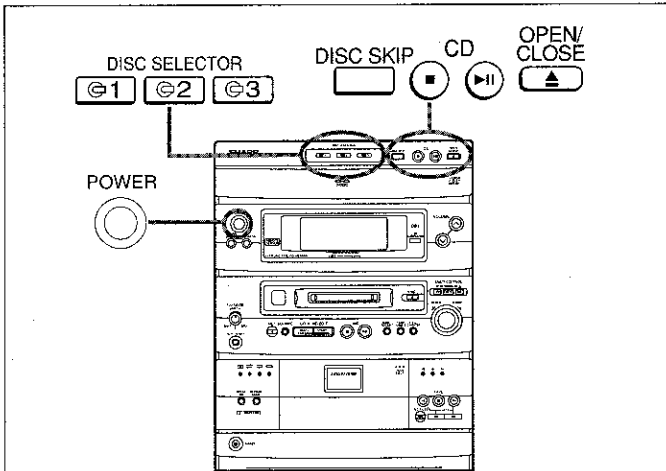

- 1 Set the POWER switch to ON.
- 2 Press the CD button.
- 3 Press the OPEN/CLOSE button to open the disc tray.
- 4 Place the CD(s) on the disc tray, label side up.
 - A CD can be placed on any open position on the disc tray.
 - Be sure to place 8 cm (3") CDs in the middle of the disc holders.

Caution:

Do not stack CDs in the tray. This can damage the player and the CDs.

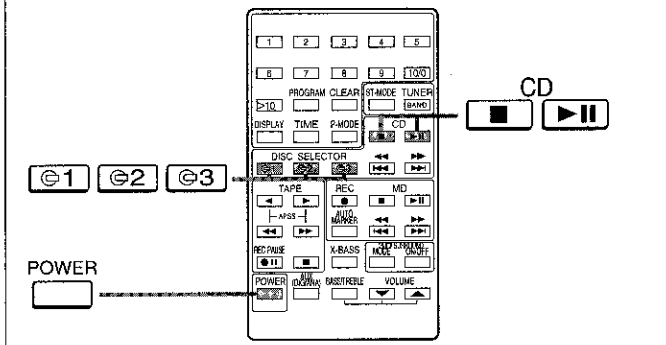

- 5 When loading a third disc, press the DISC SKIP button to turn the disc tray, then place the CD in the open position.
- 6 Press the OPEN/CLOSE button to close the disc tray.
 - The total number of tracks and the total disc playing time will be displayed. At this time, the DISC SELECTOR button on the main unit flashes.
 - The music schedule will be displayed only for the number of tracks on the disc.
 - If the CD contains more than 21 tracks, ">" will appear.
- 7 Press the desired DISC SELECTOR button (1-3).
- 8 Press the CD button.
 - Playback will begin from track 1 on the disc you have specified.
 - After the disc finishes playing, the next disc will be automatically played.
 - When there is no CD in one of the disc 1-3 positions, that position will be skipped, and the next CD will be played.
 - When the last track on the third disc has finished playing, the unit will stop automatically.

Note:

- If the OPEN/CLOSE button is pressed whilst a CD is being played, the current CD will continue its playback. The disc tray will open and you can replace any CD other than the one which is being played.

To interrupt playback:

Press the CD button.
Press the CD button to resume playback from the same point.

To stop playback:

Press the CD button.

To remove the CDs:

Whilst in the stop mode, press the OPEN/CLOSE button.

- The disc tray will open. Remove the two discs. Then, press the DISC SKIP button to rotate the disc tray and remove the remaining disc.

To switch the unit off after use:

Set the POWER switch to STAND-BY.

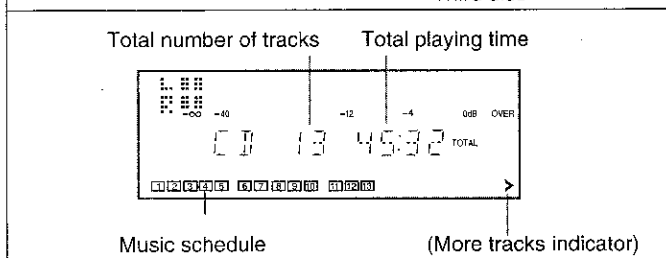
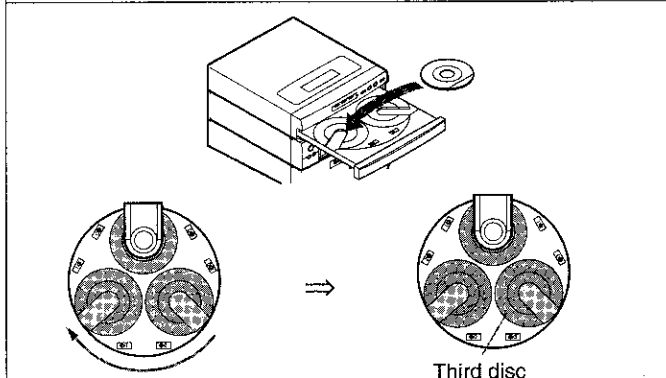

Cautions:

- **Do not carry the unit with a disc left in a disc tray. The disc may come loose inside the unit and be damaged or cause damage to the unit. This may also cause malfunctions.**
- Do not place two CDs in one disc position.
- Do not push the disc tray whilst it is moving.
- Do not attempt to turn the disc tray by hand. This may cause malfunctions.
- If the power fails whilst the tray is open, wait until the power is restored before trying to close it.
- If the disc tray is stopped forcibly, "ERROR" will appear on the display and the unit will not function.
If this occurs, turn the power off, and turn it on again.
- If TV or radio interference occurs during CD operation, move the unit away from the TV or radio.
- If the disc is damaged, dirty, or loaded upside-down, the disc will be skipped and the next disc will be automatically played.

■ To select the next disc number

- 1** When stopped, press the DISC SKIP button.
- 2** Press the CD ►|| button.
 - Playback of the next disc will begin, after which each following disc will be played sequentially.

Notes:

- When the DISC SKIP button is pressed during playback, playback will stop and resume from the next disc. (It is not necessary to press the CD ►|| button again.)
- When one of the DISC SELECTOR buttons (Ⓢ1-Ⓢ3) is pressed during playback, playback of the selected disc will begin automatically. (It is not necessary to press the CD ►|| button again.)

Direct playback

If a CD is loaded in the unit, pressing the CD ►|| button turns the power on and begins playback.

MINIDISC OPERATION

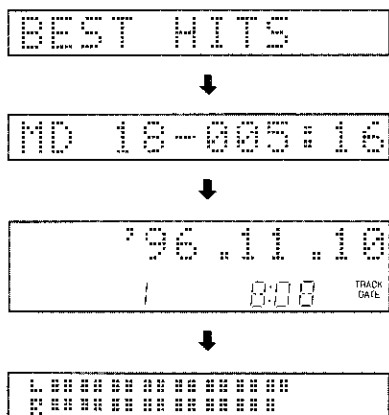
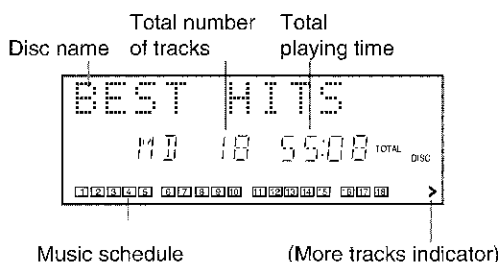
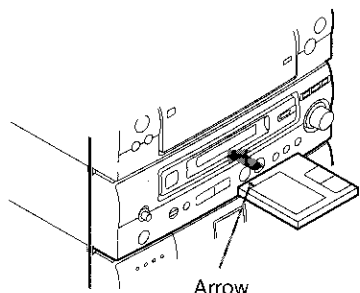
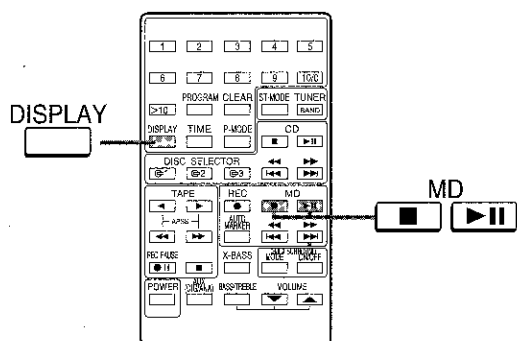
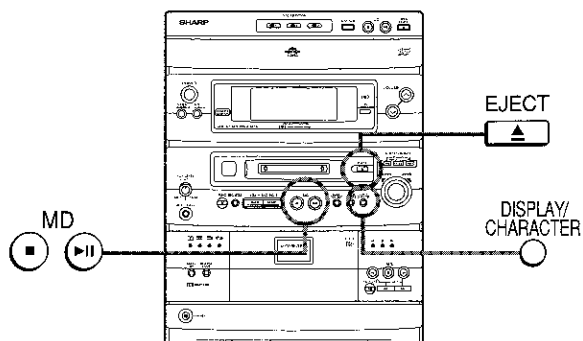

■ Loading and playing MiniDiscs

- 1 Press the MD ■ button.
- 2 Load a MiniDisc in the direction indicated by the arrow on the MiniDisc, with the labeled side facing up.
(Insert the MiniDisc firmly, until a click is heard.)
 - The total number of tracks and the total disc playing time will be displayed. At this time, the MD display will appear.
 - The music schedule will be displayed only for the number of tracks on the disc.
 - If the MD contains more than 21 tracks, ">" will appear.
- 3 Press the MD ► button.
 - When the last track has been played back, this unit will stop automatically.

To interrupt playback:

Press the MD ► button.

- Press the MD ► button to resume playback from the same point.

To stop playback

Press the MD ■ button.

To remove a MiniDisc:

Press the EJECT ▲ button.

- The MiniDisc will be ejected.

Note:

- Although vibration will not normally cause a MiniDisc to skip, you may hear a skip in the sound if there is continuous vibration. When you listen to MiniDiscs near a radio or a TV set, the radio or the TV set may pick up noise.

Keep the unit as far away as possible from tuners.

Direct playback

If a MiniDisc is loaded in the unit, pressing the MD ► button turns the power on, and begins playback.

Note

- The power cannot be turned off during reading of the information on a MiniDisc.

To check a track name or the date of a recording during playback:

Press the DISPLAY/CHARACTER button on the main unit or the DISPLAY button on the remote control during playback.

- Each time this button is pressed, the display will switch.
- In the following cases, disc names, track names and recording dates will not be displayed:
 - A MiniDisc that has not been given a disc name or track name
 - A MiniDisc that does not have a recording date on it

CASSETTE OPERATION

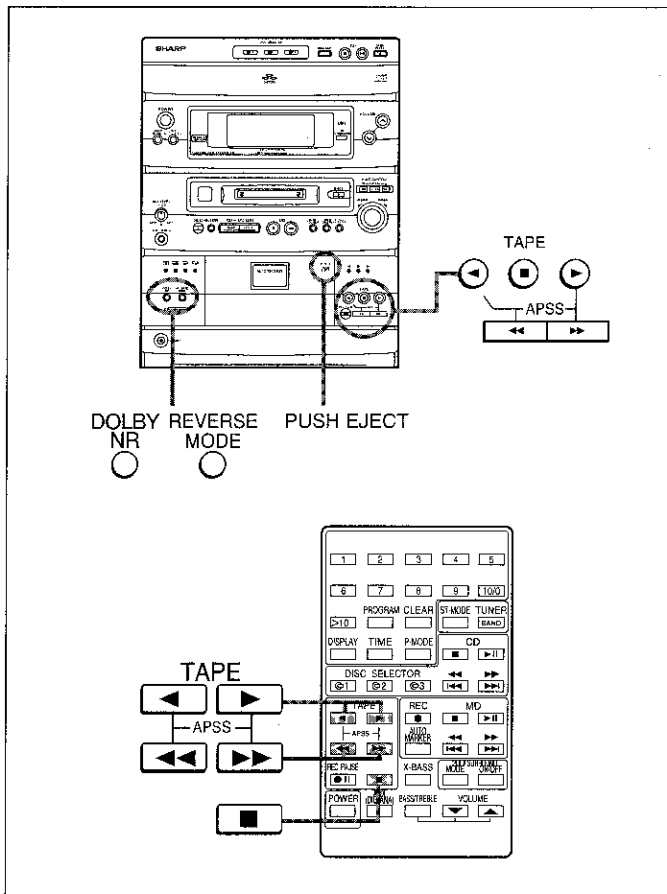
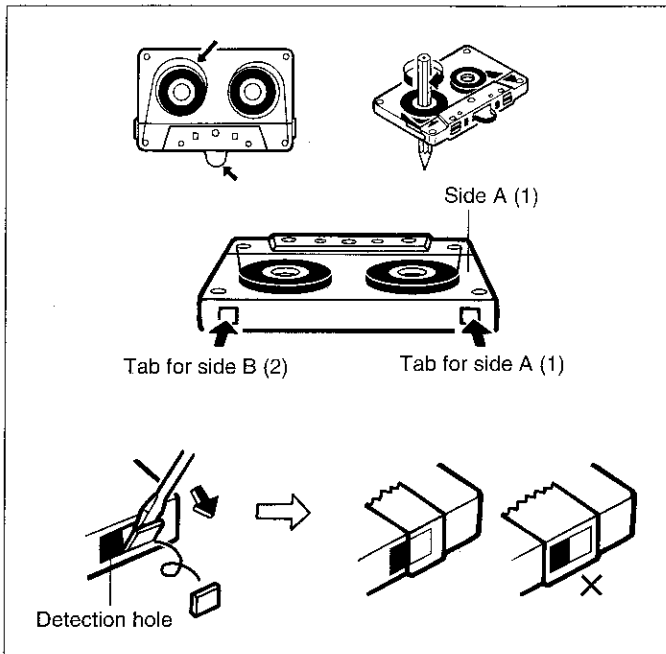

General information

- Use normal, CrO₂ or metal tape for best sound. FeCr tape is not recommended.
- Do not use C-120 tapes, tapes with large-diameter reels, or poor-quality tapes, as they may cause malfunctions.
- Before loading a tape into the cassette compartment, tighten the slack reel with a pen or pencil.
- Cassettes have removable tabs which prevent accidental recording or erasing from taking place. Removing the tab will protect the corresponding side from being erased (see diagram). Cover the tab holes with adhesive tape to erase or record again.
- This deck features an auto tape selector. Just load the tape, and the tape formula being used will be sensed automatically.
- When covering erasure-prevention tab holes, do not cover the CrO₂ and metal-detection holes located between them. Otherwise, the deck will sense the tape as normal tape.

Normal playback

- 1 Press the TAPE ■ button.
- 2 Open the cassette door by pressing the area marked "PUSH EJECT".
- 3 Load the cassette into the cassette compartment.
- 4 Press the DOLBY NR button.
 - When a tape recorded with the Dolby NR system is used, turn on the □□ indicator.
 - When a tape not recorded with the Dolby NR system is used, turn off the □□ indicator.
- 5 Press the REVERSE MODE button.
 - ⇐: To listen to one side of the tape.
 - ⇌: To listen to both sides of the tape.
 - ⏮: For endless repeat play of both sides of the tape.
- 6 Press the ▶ button to listen to side A (1), or the ◀ button for side B (2).
 - To play both sides of the tape (⇌), start from side A (1). When the tape starts playback from side B (2), side A (1) will not be played after side B (2) finishes.

To stop playback:

Press the TAPE ■ button.

Direct playback

If a tape is loaded in the unit, pressing the ◀ or ▶ button turns the power on and begins playback.

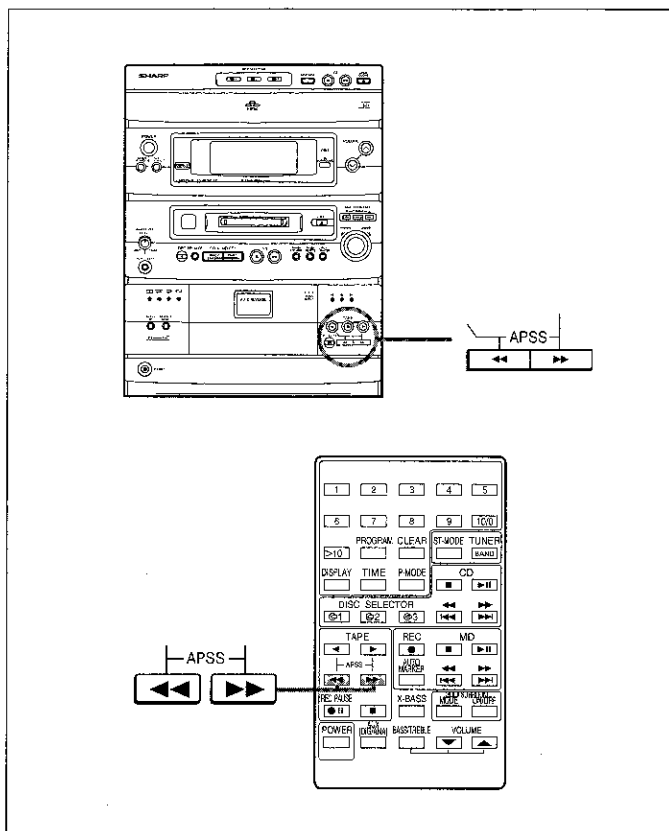

■ To fast-wind the tape

To fast-wind the tape onto the left reel

Press the TAPE ◀◀ button when the tape is stopped.

To fast-wind the tape onto the right reel

Press the TAPE ▶▶ button when the tape has stopped. The tape runs to the end and stops.

- Whilst the tape is being wound, the ◀ or ▶ indicator will flash.
- When the tape has wound to the desired point, press the TAPE ■ button.

■ Auto Programme Search System (APSS)

Perform the following operation during playback to find desired points on the tape.

To listen to the same section

Press the TAPE ◀◀ or ▶▶ button in the opposite direction as that of current playback.

To listen to the next section

Press the TAPE ◀◀ or ▶▶ button in the same direction as that of current playback.

Notes:

APSS may not work for tapes with:

- Material with long pauses or quiet passages.
- Low recording levels or excessive noise.
- Pauses of less than 4 seconds between selections.

Note:

When the APSS operation is used very close to the beginning or end section of a track, the tape may not stop at the first unrecorded section.

RADIO OPERATION

Tuning

- 1 Press the TUNER (BAND) button.
 - The power is turned on, and the tuner is selected.
- 2 Press the TUNER (BAND) button to select the desired frequency band (FM or AM).
- 3 Tune in to the desired station using the TUNING ▼ or ▲ button.

Auto tuning:

When the TUNING ▼ or ▲ button is pressed for more than 0.5 seconds and then released, the tuning stops at the first receivable broadcast station.

Notes:

- When radio interference occurs during auto tuning, auto tuning may stop automatically at that point.
- If a weak station signal is found during auto tuning, the station will be skipped.
- To stop auto tuning, press the TUNING ▼ or ▲ button again.

Manual tuning:

Press the TUNING ▼ or ▲ button as many times as necessary to adjust the frequency display to the frequency of the desired station.

- 4 To receive FM stereo, press the ST MODE button on the remote control so that the "STEREO" indicator appears.

- "ST" will appear when an FM broadcast is in stereo.
- 5 If the FM stereo reception is weak, press the ST MODE button so that the "STEREO" indicator goes out.
- Although the reception changes to monaural, the sound becomes clearer.

Preset tuning

You can preset up to 20 stations (10 FM stations and 10 AM stations) and recall them together with their FM reception mode (stereo or mono), at the press of a button.

- 1 Select the desired frequency band (FM or AM).
- 2 Tune in to the desired station using the TUNING ▼ or ▲ button.
- 3 To receive FM stereo, press the ST MODE button so that the "STEREO" indicator on the display lights up for FM stereo reception, then press the ENTER button.
- 4 Within 5 seconds, select the desired preset number with the jog dial.
- 5 Within 5 seconds, press the ENTER button.
- 6 Repeat steps 1 to 5 to preset the other stations, or to change a preset station.

To recall a preset station

- 1 Select the desired frequency band (FM or AM).
- 2 Press the tuner preset number button on the remote control or turn the jog dial on the main unit to recall the preset channel number.
 - The frequency will appear on the display.

To switch the unit off after use:

Set the POWER switch to STAND-BY.

Notes:

- The memory recalls the last station received even after changing the TUNER (BAND) button or function selector buttons, or setting the POWER switch to STAND-BY.
- After a prolonged power failure, the contents of the memory will be lost. When power is restored, enter your selections in memory again. (For power failures of just a few days or less, the contents of memory will not be lost.)

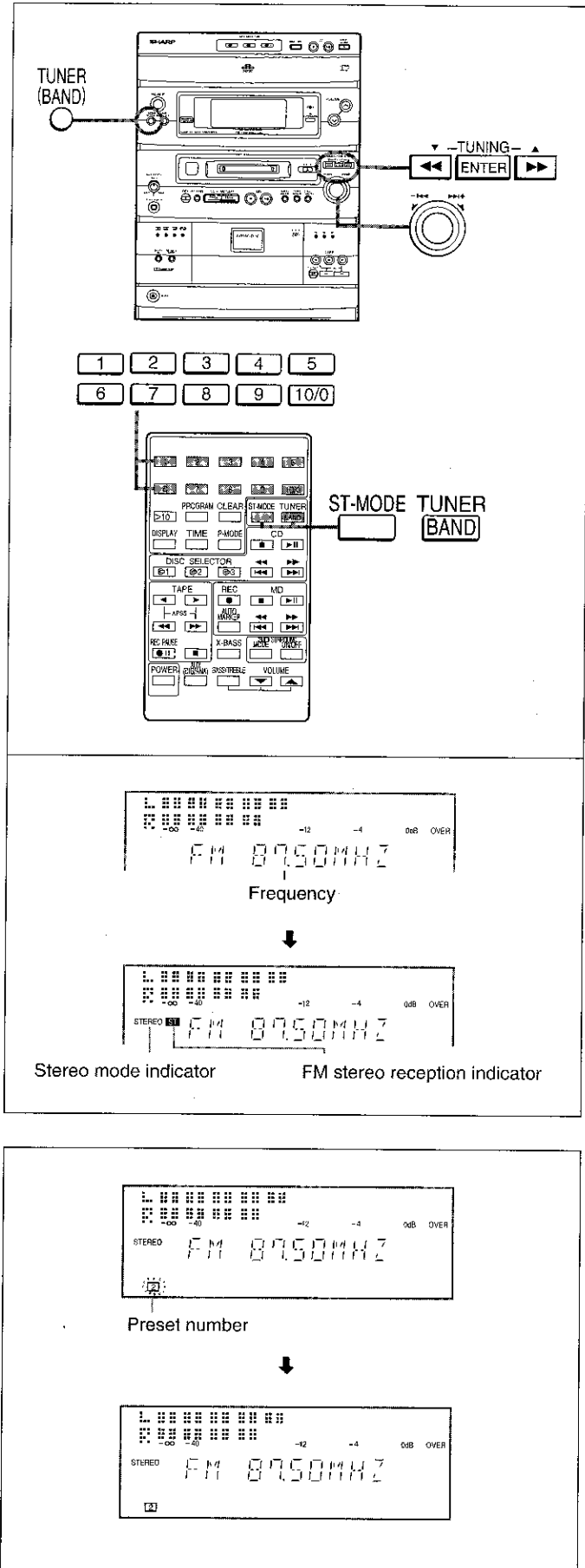

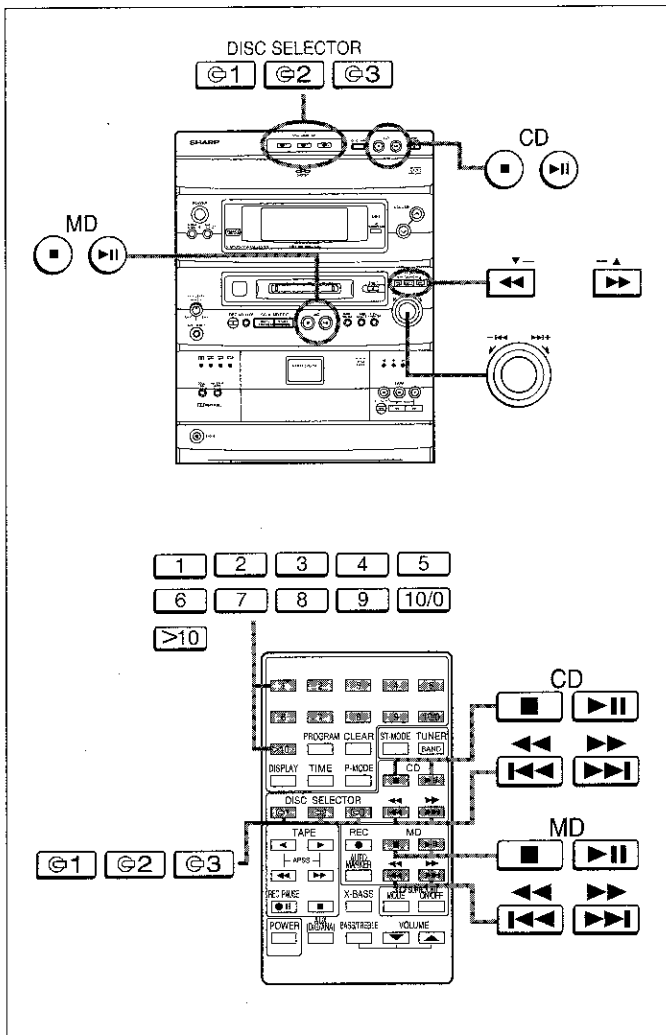

Direct-selection play

By using the track number input buttons on the remote control, any track you wish can be played directly.

- 1 Select the desired programme source, CD or MD, by pressing the CD ■ or MD ■ button.
- 2 When CD is selected, select the disc to be played by pressing one of the DISC SELECTOR (Ⓢ1 - Ⓢ3) buttons.
- 3 Use the track number input buttons to select the desired track number.

A. To select track number 11 to 99

Press the >10 button first, then press the track number. For example to select 28:

- 1 Press the >10 button.
- 2 Within 5 seconds, press the "2" button.
- 3 Within 5 seconds, press the "8" button.

B. To select track number 100 or higher (only for MD)

Press the >10 button twice, then press the track number. For example to select 105:

- 1 Press the >10 button.
- 2 Within 5 seconds, press the >10 button.
- 3 Within 5 seconds, press the "1" button.
- 4 Within 5 seconds, press the "10/0" button.
- 5 Within 5 seconds, press the "5" button.

The beginning of the selected track will be found, and play will begin automatically.

Notes:

- A track number higher than the number of tracks on the disc cannot be selected.
- During APMS play or random play, track number selection play is not possible.

APSS (Auto Programme Search System)

APSS automatically locates the beginning of each track.

To move to the beginning of the next track:

During playback ... Turn the jog dial clockwise. Or press the ►► button on the remote control.

To restart the track being played:

During playback ... Turn the jog dial anti-clockwise. Or press the ◀◀ button on the remote control.

When using the jog dial whilst in stop mode:

Every time the jog dial is turned (or each time the ◀◀ or ►► button on the remote control is pressed), the track number will go up or down by one. If you press the ►► button, playback will begin from the track being displayed.

Cue and review

- 1 Load a disc and begin playback.
- 2 Hold the ►►/►► button down for audible fast forward, and hold the ◀◀/◀◀ button down for audible fast reverse.
- 3 Normal playback will resume when the ►►/►► or ◀◀/◀◀ button is released.

Note:

- If the end of the disc is reached whilst cueing, the "DISC END" indicator will light up, and operation will pause. Press the CD ■ or MD ■ button to stop operation. When you want to listen to the disc again, press the ◀◀/◀◀ button to locate the desired track. Normal playback will start from that point.

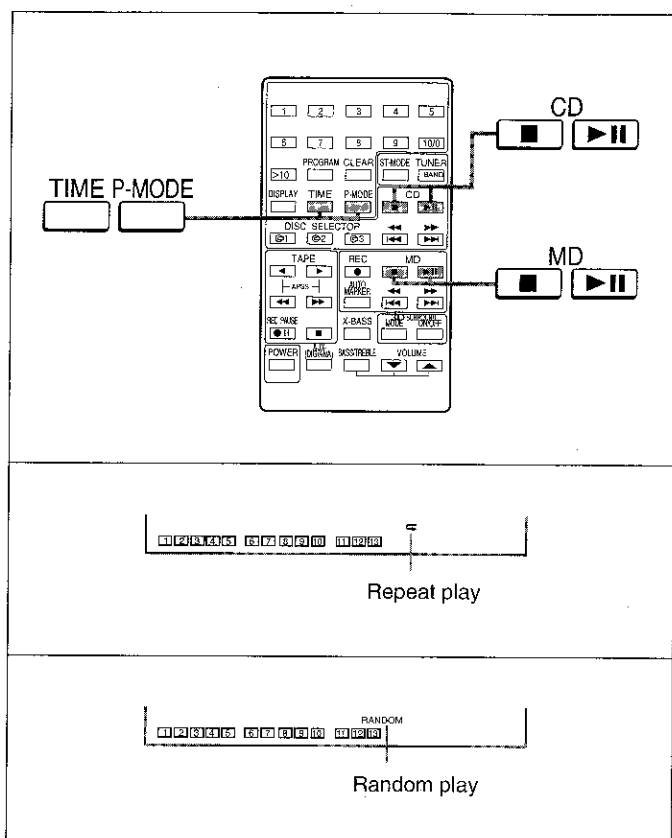

To search very quickly

When fast forward or fast reverse is used whilst in pause mode, the playback point will move more quickly than when using audible fast forward or audible fast reverse playback.

- In this mode, no sound is heard. Therefore, you must refer to the time display.
- When you lift your finger, the unit will re-enter the pause mode.

Repeat and random play

An entire disc, a single track, or a programmed sequence can be continuously repeated.

- 1 Select the desired programme source, CD or MD, by pressing the CD ■ or MD ■ button.
- 2 Press the P-MODE button.
 - Each time this button is pressed, the mode will change in the following order:
Repeat play → Random play → Normal play → Repeat play
- 3 Press the ►|| button to start playback.
 - When all of the tracks have played in random order, the unit will stop automatically.

To stop playback:

Press the CD ■ or MD ■ button.

To cancel repeat playback or random play:

Press the P-MODE button until the ◁ or "RANDOM" display disappears.

- When you open the disc tray or a MiniDisc is removed, repeat play or random play mode will be cancelled.

To repeat playback of selected tracks:

Enter the programme for the tracks you want and start repeat play. You can programme a single track and play it repeatedly.

Note:

- During APMS play, random play is not possible.

Switching the time display

Each time the TIME button is pressed during playback or pause, the display will change as described below.

See the diagram to the left

- 1 The elapsed play time for each track will be displayed.
- 2 The remaining play time for the current track will be displayed.
- 3 The total remaining play time for the disc from the point being played at that time will be displayed.

Notes:

- During random play, only the elapsed play time for each track will be displayed. The display cannot be switched.
- Depending on a CD or MD to be played, the play time display may not match the play time which is indicated on the CD or MD socket, because the time between the tracks is not included.

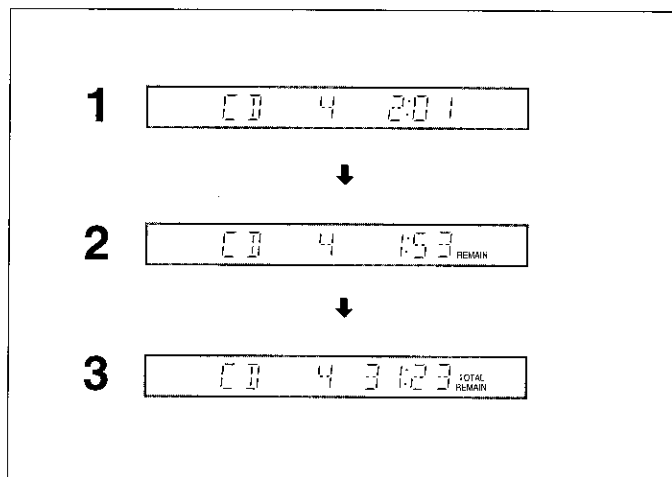

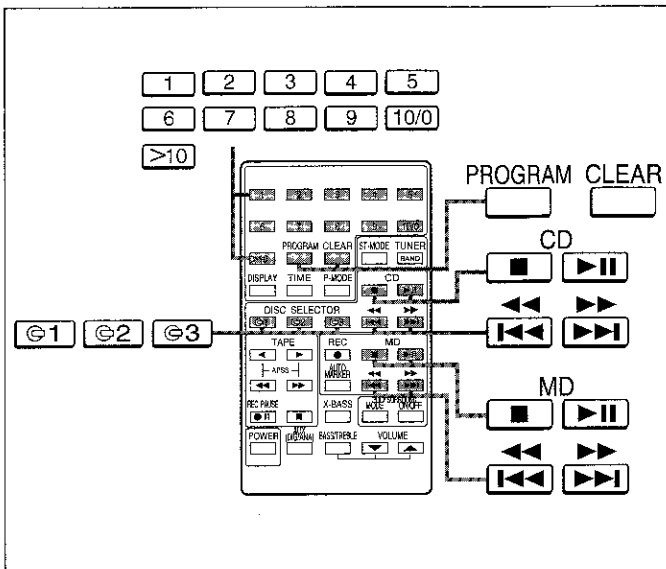

2

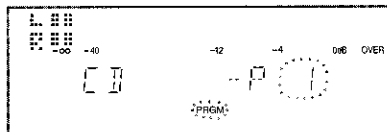

4

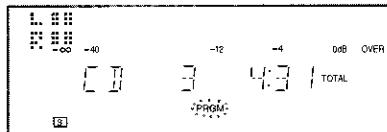

6

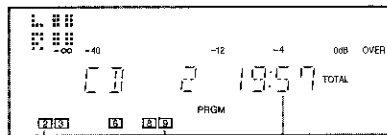

Selected track number Total playing time



7



■ APMS

(Automatic Programmable Music Selector)

Remote control operation

- 1 Select the desired programme source, CD or MD, by pressing the CD ■ or MD ■ button.
- 2 Press the PROGRAM button so that the "PRGM" indicator appears.
- 3 If you have selected CD, press one of the DISC SELECTOR (E1 - E3) buttons to select the disc to be played.
- 4 Use the track number input buttons to designate the desired track number.
- 5 Repeat step 3 and 4 for any other tracks. Up to 20 tracks for MD or 32 tracks for CD can be programmed.
 - To select the track on an MD or on the same CD, skip step 3.
 - The programmed playback order and the total play time of the programmed tracks will be automatically displayed, and only those track numbers will appear in the music schedule.
 - If the total playing time of the programmed tracks on a CD exceeds 199 minutes 59 seconds or that on an MD exceeds 99 minutes 59 seconds, "----" will be displayed. In such a case, the programmed tracks are stored.
- 6 Press the CD ■ or MD ■ button.
- 7 Press the CD ►|| or MD ►|| button to start playback of the programmed selections.
 - After all of the programmed tracks have finished playback, the unit will automatically stop.

To clear the programmed selections:

Press the CLEAR button whilst the "PRGM" indicator is flashing.

- Each time the button is pressed, one track will be cleared, beginning with the last track programmed.

To cancel the APMS:

Whilst the unit is stopped in APMS mode, press the CLEAR button to turn off the "PRGM" display.

- The programme contents will be erased.
- When you open the disc tray or a MiniDisc is removed, APMS mode will be cancelled.

To check which tracks are programmed:

Whilst the unit is stopped in APMS mode, turn the jog dial. Or press the ◀◀ or ▶▶ button on the remote control

- When the jog dial is turned clockwise, the next track number will appear. When it is turned anti-clockwise, the previous track number will appear.

To add tracks to the APMS:

When a programme has been entered (the "PRGM" indicator is flashing), perform steps 3-7. Additional tracks can be selected, and they will be stored after the last track you entered.

Note:

- It is not possible to insert an additional track between programmed tracks that have already been entered.
- Programming and cancelling are not possible during playback or in the pause mode.

BASIC INFORMATION ON MINIDISCS

Differences from tape recordings

You cannot record music on the back side of a MiniDisc.

MiniDiscs cannot be inserted when they are turned over. (Page 41)

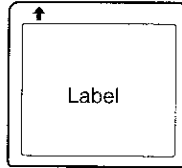

You don't need to search for the starting point at which to record.

The unit automatically finds the point at which recording can start. Recording will start from that point.

You can check the total or remaining recordable time (possible recording) before recording.

This lets you plan a recording session so that the last song will not come to an abrupt end before it has finished. (Page 22)

The date and time of a recording are automatically saved with the recording.

If you have set the date and time, they will be automatically recorded when a recording is made. (page 8)

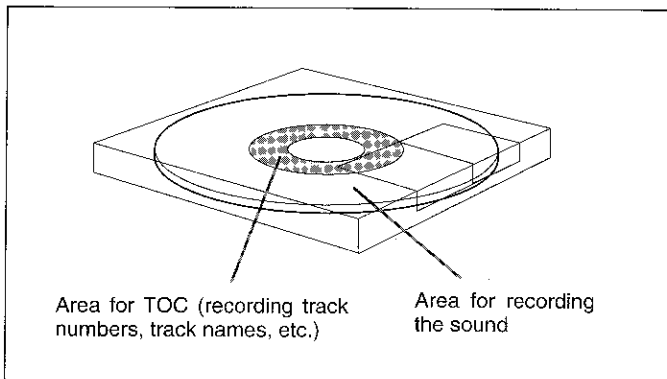

Information (TOC) to be recorded on an MD

The TOC (Table of Contents) is information on track numbers and recording areas to allow the unit to recognize musical selections or sounds.

The entire MD is controlled depending on this TOC, which enables the unit to find the beginning of a track quickly or to automatically record in a vacant area.

- The TOC is recorded in a specific area on a MiniDisc, which is not used for sound recording.

When you start recording or editing, "TOC" will appear in the display window.

This indicates that information in the TOC is now being changed according to recording or editing being performed. (The changed TOC is not yet recorded on the MiniDisc at this time.)

The TOC is recorded when

- you stop recording.
- you switch to another input source.
- you eject the MiniDisc.
- you turn the power off.

Do NOT unplug the power lead whilst the TOC is being recorded ("TOC" is flashing) and do NOT impart shock to the unit. Otherwise, TOC will not be correctly recorded, and consequently proper playback may not be possible.

Note about making digital copies

MiniDiscs are designed so that further copies cannot be made from digitally recorded MiniDisc tracks. This is a specification of the SCMS (Serial Copy Management System).

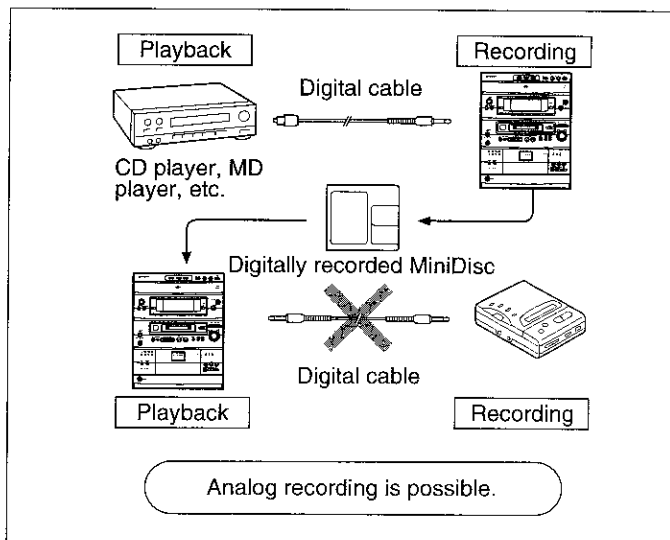

Synchro marker function

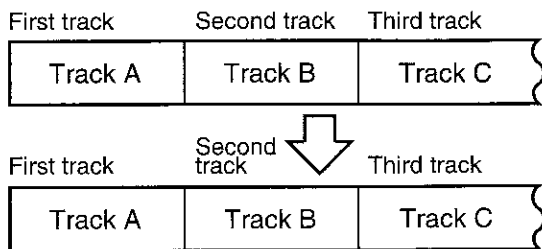

Radio recording

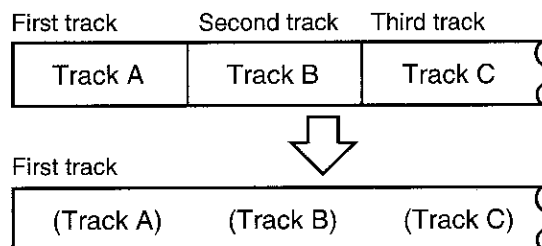

Auto marker function

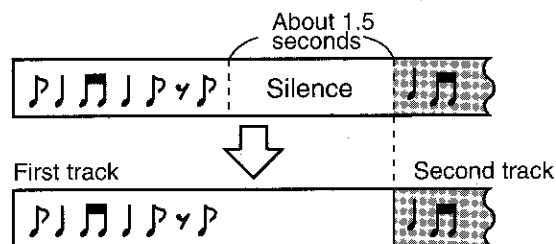

Stereo mode



Monaural long-play mode

About track numbers

When you make a recording on a MiniDisc, track numbers are created automatically. The track numbers will increment in sequence when you make any additional recording.

When recording from another MiniDisc or CD

New track numbers will be created automatically according to the original tracks (Synchro marker function).

- When you record from a CD to a MiniDisc, the track numbers recorded on the MiniDisc may not match the track numbers on the CD.
- When recording from digital equipment such as a DAT tape recorder, the Synchro marker function will not work.

When recording from a radio

One continuous recording is regarded as a single track.

When recording from a tape or external analogue equipment

If there is 1.5 seconds or more of silence, the blank space is assumed to be the space between tracks, and a new track number is created automatically (Auto marker function).

- If the signal to be recorded contains some noise, the track numbers may not be properly created.
- You can also record musical selections as a single track without using the Auto marker function.
- The Auto marker function can also be activated for external digital equipment, such as a DAT tape recorder.

About monaural long-play mode

When a recording is made in the monaural long-play mode, the length of the recording can be double that of a stereo recording for the same amount of space on the MD. The monaural long-play mode is very useful for recording songs that were originally recorded in monaural, or for recording talk programmes.

Press the REC MODE button on the main unit.

- Each time the button is pressed, the display will switch between the stereo mode and the monaural long-play mode.
- This mode cannot be changed whilst recording.
- The level meter shows stereo indication even when the mode is the monaural long-play mode.
- The recording mode will not change back until you change it manually. After you have made a recording in the monaural long-play mode, it is recommended that you return the unit to the stereo mode so that you won't forget to do so later.

RECORDING

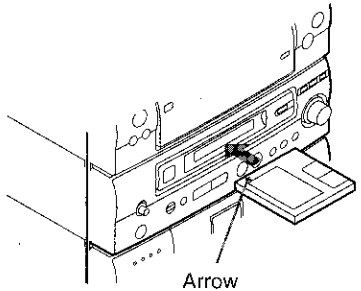
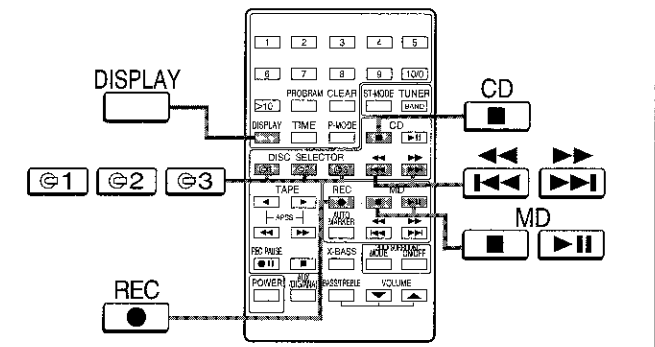
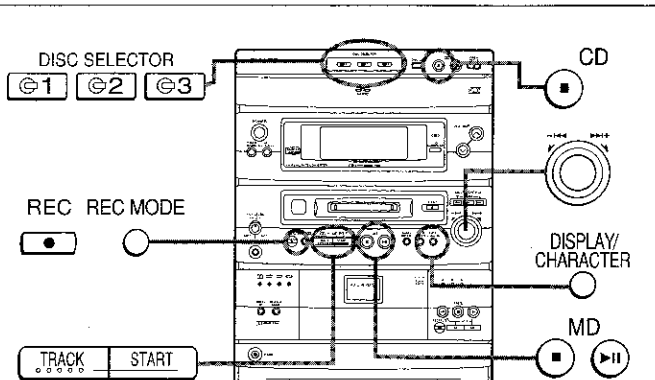

Record mode

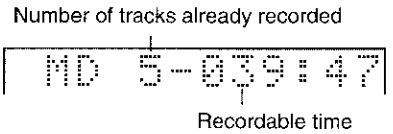

Recording from a CD onto a MiniDisc (One-Touch Editing)

- 1 Press the CD button, and load the compact discs.
 - 2 Select a disc by pressing one of the DISC SELECTOR (1 - 3) buttons.
 - 3 Load a recordable MiniDisc.
 - 4 Check the record mode by pressing the REC MODE button.
 - 5 Press the START button.
- Playback of the first track of the selected disc and recording begin.
 - When all discs are recorded, recording automatically stops.

To stop recording

Press the CD button.
After recording the track number, playback and recording stops. It is not possible to pause recording.

If recording does not begin

If the recordable time on the loaded MiniDisc is insufficient for recording all of the selected discs, the recordable DISC SELECTOR (1 - 3) button flashes, and the recordable number of tracks and the track numbers are displayed. Press the flashing DISC SELECTOR (1 - 3) button, and the number of tracks and track numbers which cannot be recorded are displayed.

To record only the recordable tracks

Press the START button.

To check the remaining recordable time

- 1 Load a MiniDisc.
 - 2 Press the MD button.
 - 3 Press the DISPLAY/CHARACTER button on the main unit or the DISPLAY button on the remote control.
- The number of tracks already recorded, and the recordable time are displayed.

To rerecord

If you wish to rerecord, you can erase a track that is already recorded, starting from any point in the old track, to begin a new recording. Be aware that when you do this, all of the tracks and track names that follow the newly recorded track will be erased.

- 1 During playback, press the MD button at the point where you wish to begin rerecording.
- The unit will pause.
- 2 Press the REC button.
- The unit will enter record stand-by mode.
- 3 Select the recording source and start recording.

(Continued)

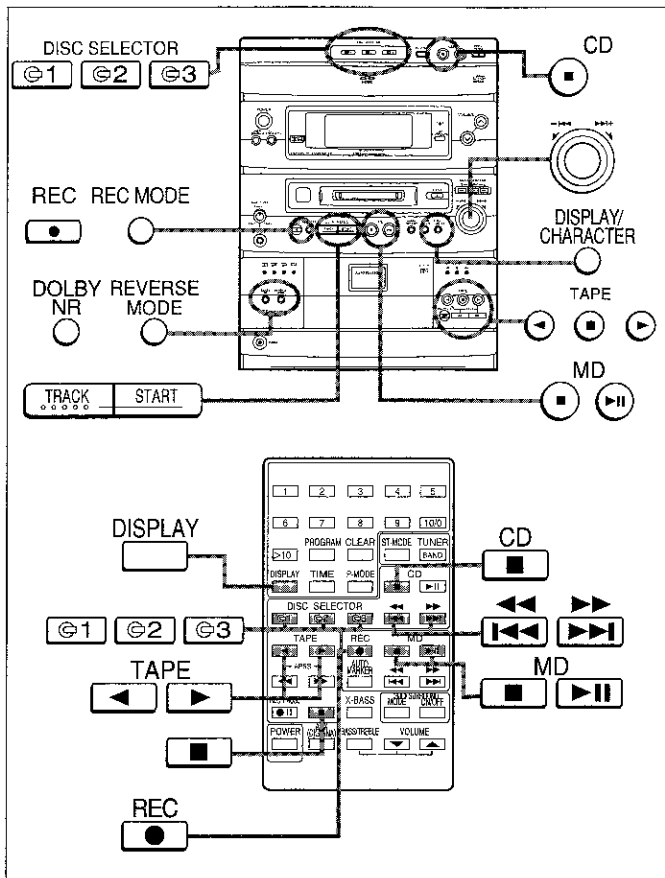

Recording desired tracks from a compact disc onto a MiniDisc (Track Editing)

- 1 Press the CD button, and load compact discs.
- 2 Select a disc by pressing one of the DISC SELECTOR (E1-E3) buttons.
- 3 Load a recordable MiniDisc.
- 4 Select the track to start recording by turning the jog dial on the main unit or the CD / or / button on the remote control.
 - The selected track number appears.
- 5 Press the TRACK button.
 - To record a single track, skip to step 7.
- 6 Select the track to start recording by pressing the TRACK button.
- 7 Press the START button.
 - When all tracks are recorded, recording automatically stops.

To cancel the track edit operation

Press the CD or MD button before pressing the START button.

Recording from the built-in radio onto a MiniDisc

- 1 Tune in the radio station to be recorded.
- 2 Load a recordable MiniDisc.
- 3 Press the REC button.
 - The unit will enter record stand-by mode.
- 4 Check the recordable time by pressing the DISPLAY/CHARACTER button on the main unit or the DISPLAY button on the remote control.
- 5 Press the MD button.
 - During recording, you cannot change the station.

To stop recording

Press the MD button.
After recording the track number, recording stops.

To interrupt recording

Press the MD button during recording.
Press the MD button again to resume recording. The track number increases.

To record the track number during recording

Press the REC button.

Recording from a cassette onto a MiniDisc

- 1 Load a cassette for playback.
- 2 Check the playback direction by pressing the REVERSE MODE button.
- 3 Select the Dolby NR mode.
 - When recording with the Dolby NR system, turn on the indicator.
- 4 Press the MD button.
- 5 Load a recordable MiniDisc.
- 6 Press the REC button.
 - The unit will enter record stand-by mode.
- 7 Check the recordable time by pressing the DISPLAY/CHARACTER button on the main unit or the DISPLAY button on the remote control.
- 8 Start playback of the cassette tape by pressing the button for side A (1) or the button for side B (2).
 - Recording begins.
 - To record both sides of a tape, be sure to start playback on side A (1).

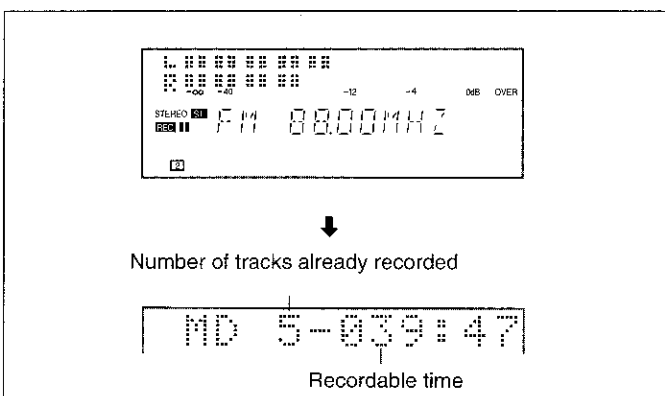
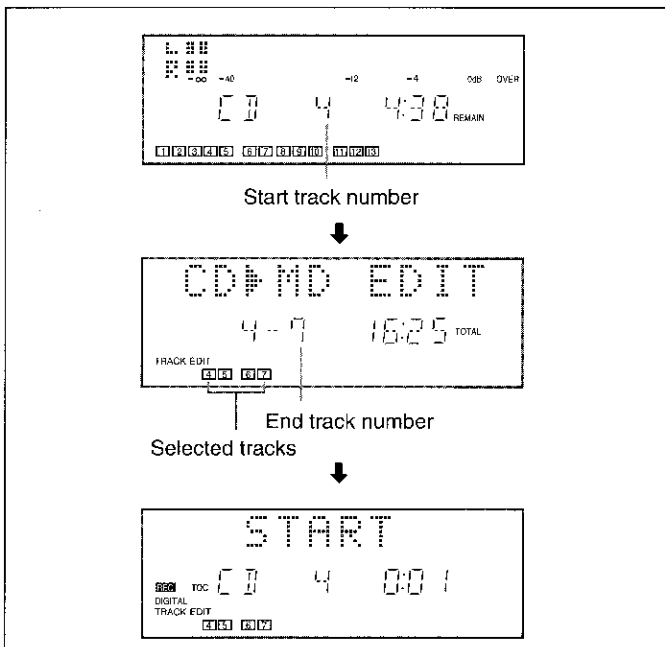

(Continued)

If the recordable time is insufficient

If the recordable time on a MiniDisc is shorter than the playback time of the tape, recording is interrupted. Press the TAPE ■ button to stop the tape.

To stop recording

Press the TAPE ■ button.
 After recording the track number, playback stops and the MD section enters record stand-by mode.
 Press the MD ■ button release stand-by mode.

To interrupt recording

Press the MD ►|| button.
 Press the MD ►|| button again to resume recording.
 The track number increases.

■ Recording from a CD player onto a cassette tape (CD Synchronized Recording System)

- 1 Load a cassette into the cassette compartment.
- 2 Select the tape running direction by pressing the REVERSE MODE button.
 ☐: To record on only one side.
 ☐☐: To record on both sides.
- 3 Select the DOLBY NR mode.
 ● When recording with the Dolby NR system, turn on the □□ indicator.
- 4 Press the REC PAUSE ●|| button to set the unit to record stand-by mode.
- 5 Press the CD ■ button, and load CDs.
- 6 Select a disc for recording by pressing one of the DISC SELECTOR (ⓐ1 - ⓐ3) buttons.
 ● When a specific track number is designated, recording will begin from that track.
- 7 Press the CD ►|| button.
 ● The specified track of the CD is played back and recording begins.
 When recording is finished, the CD automatically stops.
 ● When recording is finished, the tape section enters record stand-by mode. Press the TAPE ■ button to release record stand-by mode.

To interrupt recording

Press the CD ►|| button.
 Press the CD ►|| button to resume recording.

To stop recording:

Press the CD ■ button.
 The tape section will enter record stand-by mode.
 Press the TAPE ■ button to release stand-by mode.

To record continuously on both sides of the tape:

Even if the last track of side A has not finished recording, side B will automatically start recording from the beginning of that track. (Auto Restart Function)
 Recording will be made without cutting the beginning of the track on side B.

Notes:

The track editing function is used for recording on a tape. Set the tape section to record stand-by mode, perform steps 4 - 7 of the "Recording desired tracks from a compact disc onto a MiniDisc" section on page 23.

- When recording is finished, playback of a CD stops, and the tape section enters record stand-by mode.
- Even if the remaining recordable time on a tape is insufficient, the "EDIT OVER" display does not appear.

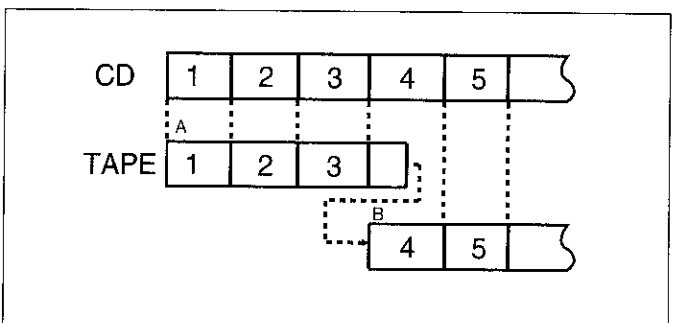
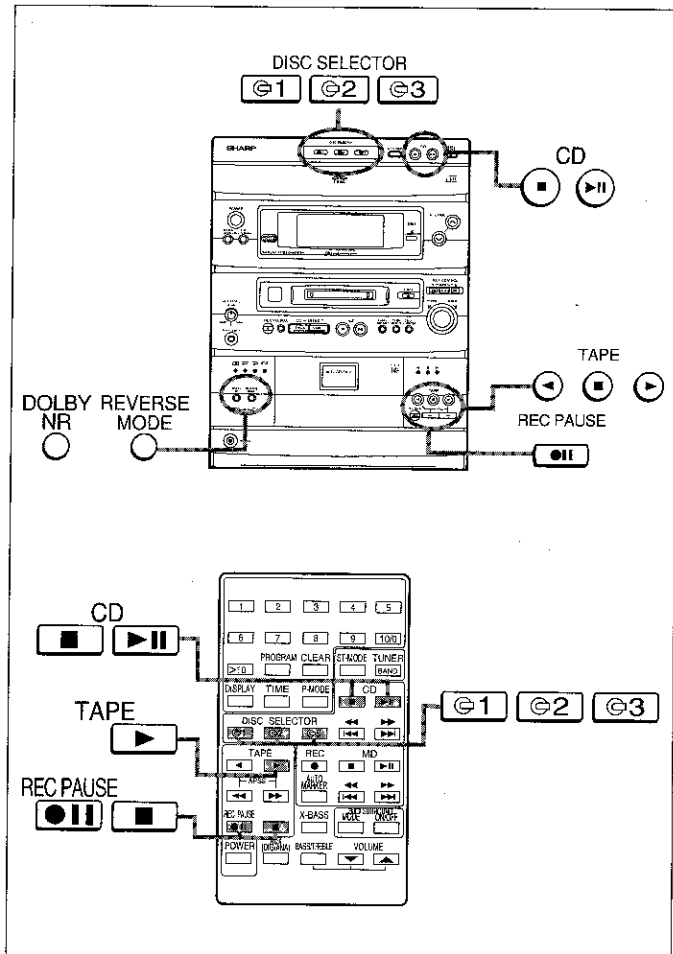

(Continued)

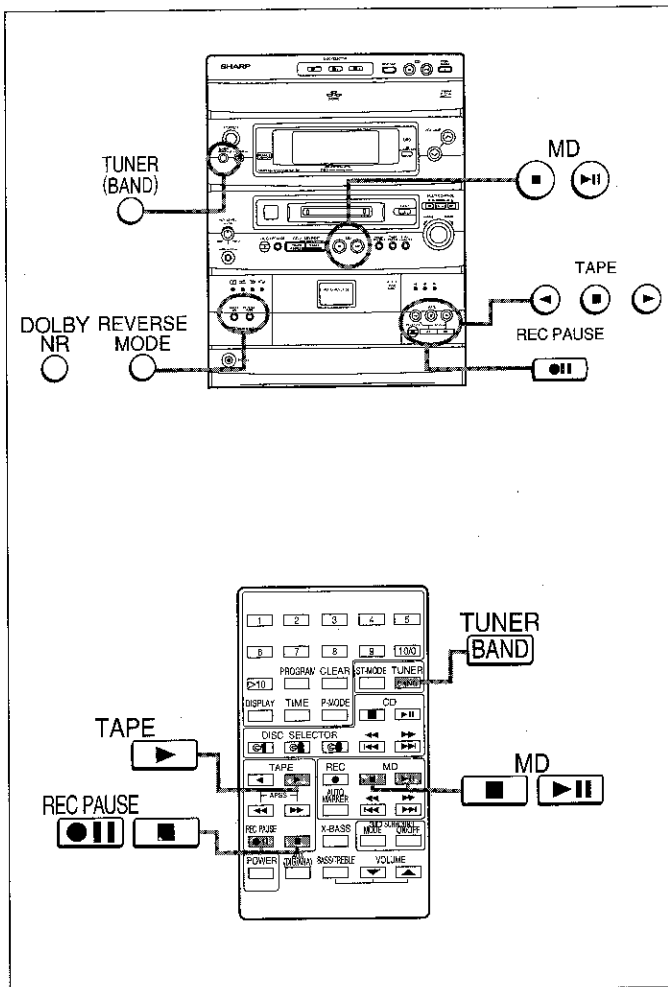

■ Recording from the built-in radio onto a cassette tape

- 1 Tune in to the desired station.
- 2 Load a cassette into the cassette compartment.
- 3 Select the tape running direction by pressing the REVERSE MODE button.
 - ⇐: To record on only one side.
 - ⇔: To record on both sides.
- 4 Select the DOLBY NR mode.
 - When recording with the Dolby NR system, turn on the indicator.
- 5 Press the REC PAUSE button to set the unit to record stand-by mode.
- 6 Press the button to start recording.

To interrupt recording:

Press the REC PAUSE button.
Press the TAPE button to resume recording.

To stop recording:

Press the TAPE button.

Beat cancel switch (on the rear panel)

If a whistling noise occurs when recording from AM, set the BEAT CANCEL switch to A or B, whichever gives the best reception.

■ Recording from a MiniDisc onto a cassette tape

- 1 Load a cassette into the cassette compartment.
- 2 Select the tape running direction by pressing the REVERSE MODE button.
 - ⇐: To record on only one side.
 - ⇔: To record on both sides.
- 3 Select the DOLBY NR mode.
 - When recording with the Dolby NR system, turn on the indicator.
- 4 Press the REC PAUSE button to set the unit to record stand-by mode.
- 5 Press the MD button, and load a MiniDisc.
 - When a specific track number is designated, recording will begin from that track.
- 6 Press the MD button.
 - Recording will automatically begin from the track 1 of the MD. When playback of the MD is finished, the MD automatically stops.
 - When recording is finished, the tape section enters record stand-by mode. Press the TAPE button to release record stand-by mode.

To interrupt recording:

Press the REC PAUSE button.
Press the TAPE button to resume recording.

We will explain the 5 editing functions with which you can create your own original discs from recorded MiniDiscs. Playback-only MiniDiscs cannot be edited.

DIVIDE

A track can be divided into two tracks. If two selections were recorded as a single track because there was not enough silent space between the pieces, you can use the DIVIDE function to separate the selections.

This feature is also convenient for identifying specific points with one selection so that you can locate those points easily whenever you like.

(Page 28)

COMBINE

Two adjacent tracks (for example, the third and fourth tracks) can be combined.

If there is a prolonged silent section in the middle of a selection that is recorded, a single piece of music may be recorded as two tracks. If this happens, these two tracks can be combined into a single track.

(Page 28)

ERASE

Tracks you want to erase can be erased one at a time or all at once.

Once a track has been erased, it cannot be recovered.

Double-check the track number before erasing it.

(Page 30)

MOVE

The order of the recorded tracks can be changed. This feature is different from programme play. A new track order can be recorded directly on the disc. When the power is turned off, the revised order will not be changed.

(Page 29)

Programme move function

This function allows the track numbers to be automatically rearranged in the order specified for programmed playback. The track numbers will be adjusted as needed, automatically.

(The tracks that are not included in the programmed selections will be put at the end of the new track numbers.)

(Page 29)

TRACK/DISC NAME

You can assign titles to recorded tracks and to discs. The characters must be capital and lowercase letters, or symbols. Track and disc names can use up to 40 characters per name.

(Page 31)

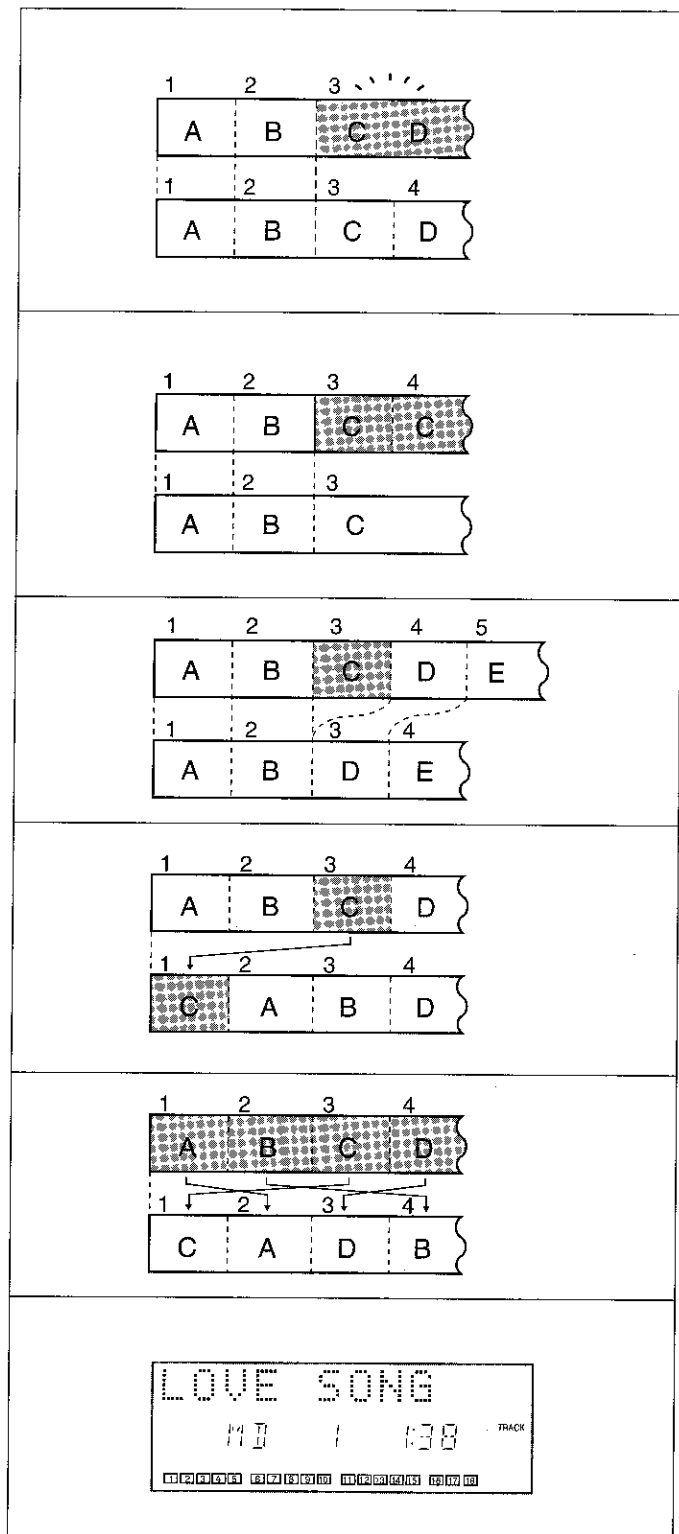

■ Using the editing function

We will show you some examples of how to use the editing functions. You can create a disc of your favourite selections by recording tracks from a variety of input sources such as CDs, tapes, and radio broadcasts.

STEP 1

Recording tracks to be edited on an MD



STEP 2

Putting the space between tracks in order



STEP 3

Cutting unnecessary sections



STEP 4

Rearranging tracks in your preferred order



STEP 5

Finish by putting names on the disc and tracks

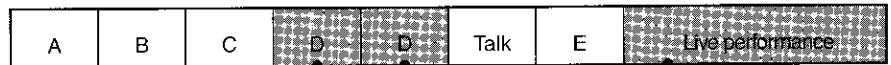
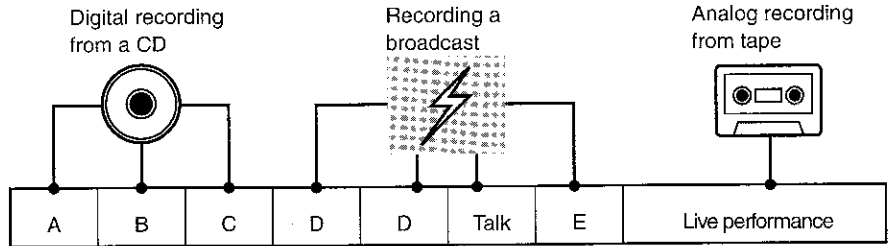

The tracks are combined using the combine function.

The tracks are divided using the divide function.



Cut using the erase function.

Cut using the erase function.



The tracks are rearranged using the programme move function.

The track is moved using the move function.

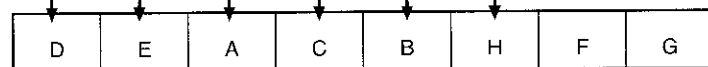

BEST HITS

(Disc name)

LOVE SONG

(Track name)

■ Edit Menu

The editing functions are selected from the edit menu. The functions which can be selected from the edit menu will vary, depending on the state in which an editing operation is started.

STEP 1 Edit menu display

Press the NAME•TOC EDIT button. Each time the button is pressed, the edit menu will appear.



(Move function)

•A different menu may be displayed.



STEP 2 Edit menu selection

Turn the jog dial. Each time the dial is turned, the menus will appear in order.



(Track name function)

•Within 10 seconds, perform step 3.



STEP 3 Editing start

Press the ENTER button. You can edit the selected menus.

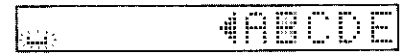

•To stop editing at anytime, press the MD button.

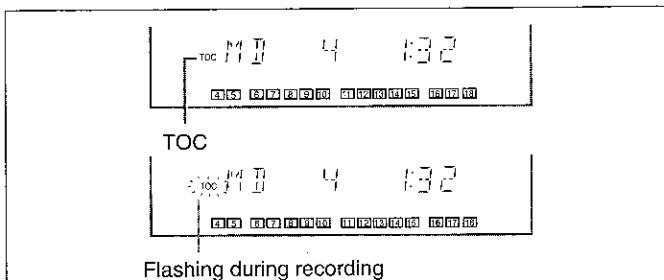

■ Recording the editing results

Whilst editing, the "TOC" indicator is displayed. This means that the editing results have not been recorded on the MiniDisc. To record the results, select another input or turn the power off. During writing, the "TOC" display is flashing. When the "TOC" goes out, writing the editing results is complete.

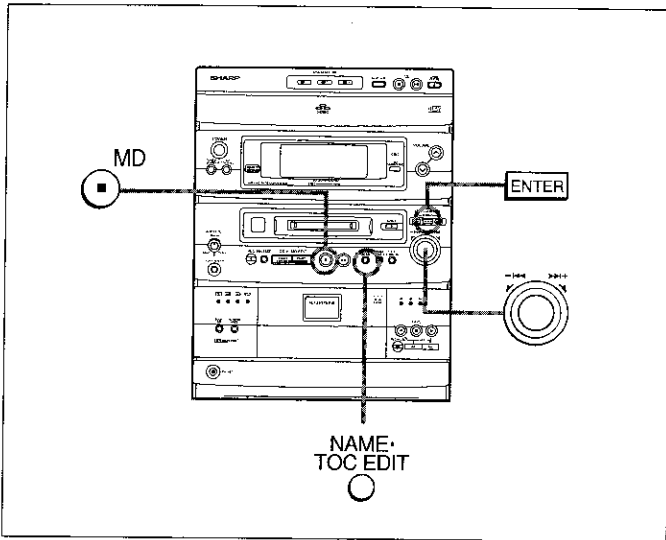

■ DIVIDE

Main Unit operation

- 1 Play the track which you wish to divide into two and press the ►|| button at the point where you wish to divide the track.
 - The unit will enter pause mode.
- 2 Press the NAME•TOC EDIT button, and then select "DIVIDE" using the jog dial.
- 3 Within 10 seconds, press the ENTER button.
 - To cancel the operation, press the MD ■ button.
- 4 Press the ENTER button again.
 - The tracks are divided, and the unit is stopped at the beginning of the second of the two tracks.
 - The numbers of the tracks which come after the divided track are automatically increased by one.
 - When a track which has been given a name is divided, the two new tracks will have the same name and date. If the "TOC FULL" message is displayed, the second track may not be given a name.

Notes:

- This unit can hold up to 255 tracks. However, even if the number of tracks assigned has not reached 255, it might not be possible to make any further divisions of tracks. (Page 41)
- This function cannot be used whilst a programme is being entered ("PRGM" is lit: Page 19) or whilst in random play mode ("RANDOM" is lit: Page 18). First, cancel the programme or random play mode before trying to use this function.

■ COMBINE

Main Unit operation

- 1 Whilst in stop mode, select the second of the two tracks you wish to combine using the jog dial.

Or start playing the second of the two tracks you wish to combine, and then press the MD ►|| button.

 - The unit will enter pause mode.
- 2 Press the NAME•TOC EDIT button, and then select "COMBINE" using the jog dial.
- 3 Within 10 seconds, press the ENTER button.
 - To cancel the operation, press the MD ■ button.
- 4 Press the ENTER button again.
 - The two tracks are combined, and the unit is stopped at the beginning of the combined track.
 - The numbers assigned to the tracks following the combined track are automatically decreased by one.

When both tracks have a name:

- When only the first track has a name → That name will be used.
- When only the second of the two tracks has a name → That name will be used.
- When both tracks have a name → The name of the first track will be used.

To combine two noncontiguous tracks:

(Example: the first and third tracks)

Move the third track to the second track using the MOVE function. (Page 29)

Then, combine the first and second tracks using the COMBINE function.

Notes:

- Tracks recorded from analogue inputs cannot be combined with tracks recorded from CDs or MDs using the digital inputs.
- Tracks recorded in stereo mode cannot be combined with tracks recorded in monaural long-play mode.
- Tracks where either track's recording time is less than 15 seconds may not be combined.

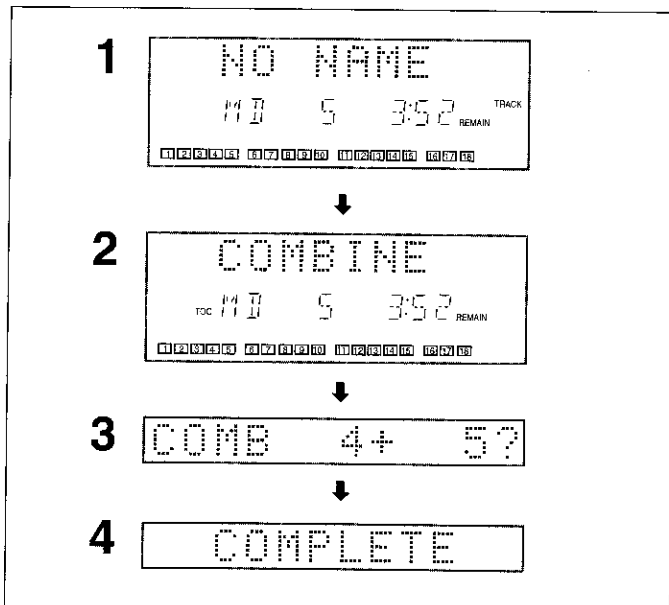
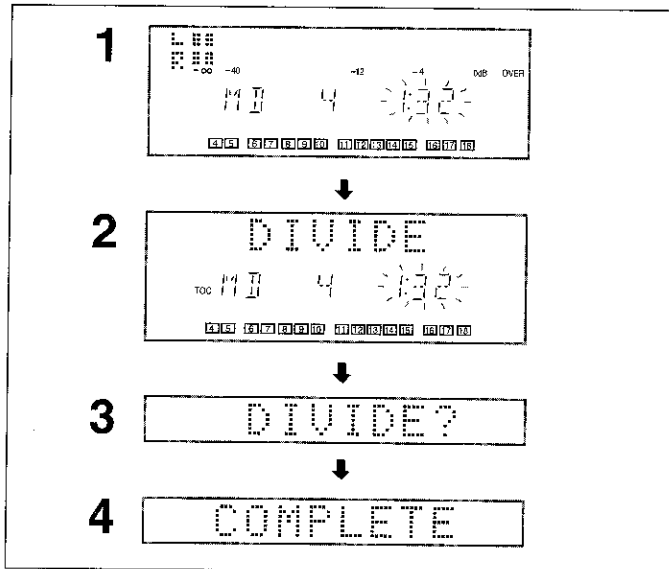

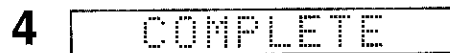
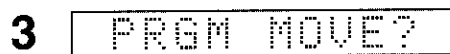
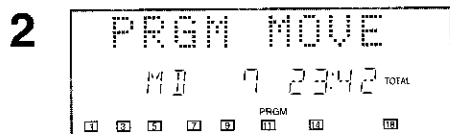
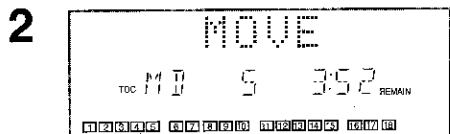
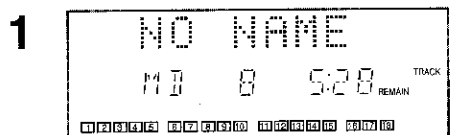
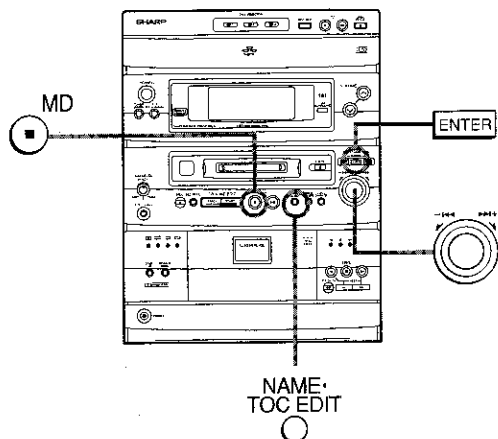

MOVE

Main Unit operation

- 1 Whilst in stop mode, select the track you wish to move using the jog dial.
Or start playing the track to be moved, and then press the MD ►► button.
 - The unit will enter pause mode.
- 2 Press the NAME•TOC EDIT button, and then select "MOVE" using the jog dial.
- 3 Within 10 seconds, press the ENTER button.
- 4 Select the direction to move the track using the jog dial.
 - To increase the track number ... ►►
 - To decrease the track number ... ◀◀
 - To cancel the operation, press the MD ■ button.
- 5 Press the ENTER button again.
 - The track is moved, and the unit is stopped at the beginning of the track.

Note:

- When a track has been moved, the other tracks which are affected will be assigned new track numbers automatically.

Example: When moving the fifth track to the third track, the old third track will become the new fourth track, and the old fourth track will become the new fifth track.

- This function cannot be used whilst a programme is being entered ("PRGM" is lit: Page 19) or whilst in random play mode ("RANDOM" is lit: Page 18). First, cancel programme or random play mode before trying to use this function.

Programmed move

- 1 Select the tracks you want to move and enter them into a programme. (Page 19)
- 2 Make sure that the "PRGM" indicator is lit, and then press the NAME•TOC EDIT button.
- 3 Within 10 seconds, press the ENTER button.
 - To cancel the operation, press the MD ■ button.
- 4 Press the ENTER button again.
 - The tracks will be moved, and programmed move mode will end.

Notes:

- The track numbers that are not included in the programmed selections will be put at the end of the new track numbers.
- When the same track has been entered into the programme twice or more, the last programmed position will have priority.

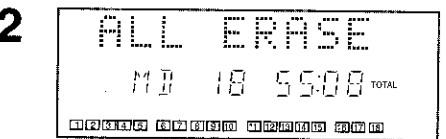
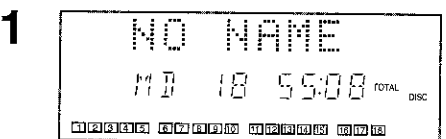
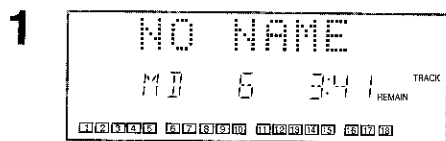
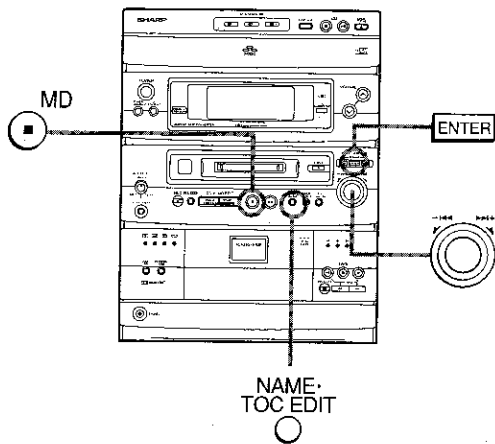

■ ERASE

Main Unit operation

To erase tracks one at a time:

- 1** Whilst in stop mode, select the track to be erased using the jog dial.
Or start playing the track you wish to erase, and press the MD ► button.
 - The unit will enter pause mode.
- 2** Press the NAME•TOC EDIT button, and then select "ERASE" using the jog dial.
- 3** Within 10 seconds, press the ENTER button.
 - To cancel the operation, press the MD ■ button.
- 4** Press the ENTER button again.
 - The track is erased, and the unit is stopped at the beginning of the previous track.

Notes:

- Once a track has been erased, it cannot be recovered. Double-check the track number before erasing it.
- When a track is erased, the numbers assigned to the tracks following the erased track will be automatically decreased by one.
- When a track is erased, the track name will be erased at the same time.

To erase all of the tracks at once:

- 1** Press the MD ■ button.
 - The total number of tracks and the total playing time for the MD will be displayed.
- 2** Press the NAME•TOC EDIT button, and then select "ALL ERASE" using the jog dial.
- 3** Within 10 seconds, press the ENTER button.
 - To cancel the operation, press the MD ■ button.
- 4** Press the ENTER button again.
 - All of the track numbers and track names will be erased.

Note:

- This function cannot be used whilst a programme is being entered ("PRGM" is lit: Page 19) or whilst in random play mode ("RANDOM" is lit: Page 18). First, cancel programme or random play mode before trying to use this function.

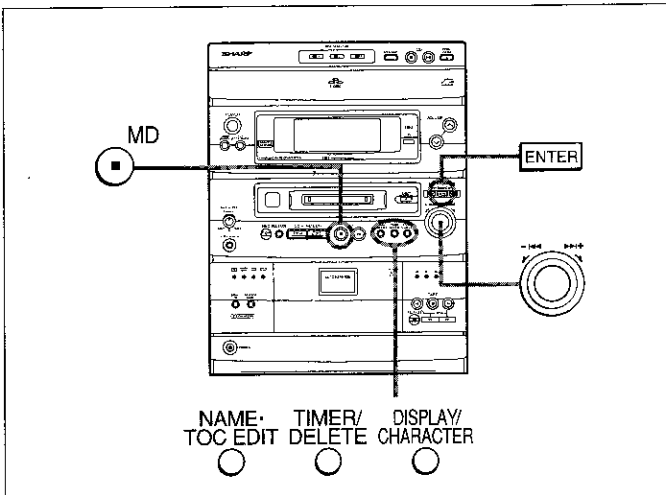

STEP 1

DISPLAY/ CHARACTER

Alphabetic (capital letters) ◀ ABCDE

↓

Alphabetic (lower-case letters) ◀ abcde

↓

Numbers or symbols ◀ 12345

STEP 2

▶ ABCDE

Cursor ↓

▶ ABODE

↓

▶ EFGHIJ

↓

▶ KLMNO

When you turn the jog dial with the cursor at the edge of the display, another 5 characters will be displayed.

Move the cursor to the desired character with the jog dial.

STEP 3

ENTER

▶ L ◀ KLMNO

Track/disc name

Main Unit operation

- Up to 255 tracks can be named on each disc, and each disc can be given a disc name.

When naming discs and tracks, the characters should be entered as follows:

To select the type of characters (STEP 1):

Press the DISPLAY/CHARACTER button. Each time the button is pressed, the available characters will be switched as shown at left.

To select characters (STEP 2):

Select characters using the jog dial. Each time the dial is turned, the cursor over the character will move.

To enter characters (STEP 3):

Press the ENTER button. The selected character will be entered in the character input column.

Repeat STEP 1 to STEP 3 as necessary to enter the characters of the name.

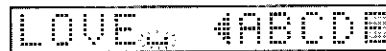

Type of characters used:

Type of characters	Characters
Capital letters	A B C D E F G H I J K L M N O
	P Q R S T U V W X Y Z . / _
Lower-case letters	a b c d e f g h i j k l m n o
	p q r s t u v w x y z . / _
Symbols	1 2 3 4 5 6 7 8 9 0 ! " # \$ %
	& ' () * + , - . / : ; < = > ? @ _

Notes:

Number of characters you can enter

Disc names and track names

Up to 40 characters (including spaces) can be entered for each name. If more than 40 characters are entered, "NAME FULL" will appear.

Total number of characters per MiniDisc

A total of approximately 1700 characters can be used for all of the disc and track names. If more than 1700 characters are entered, "TOC FULL" will appear.

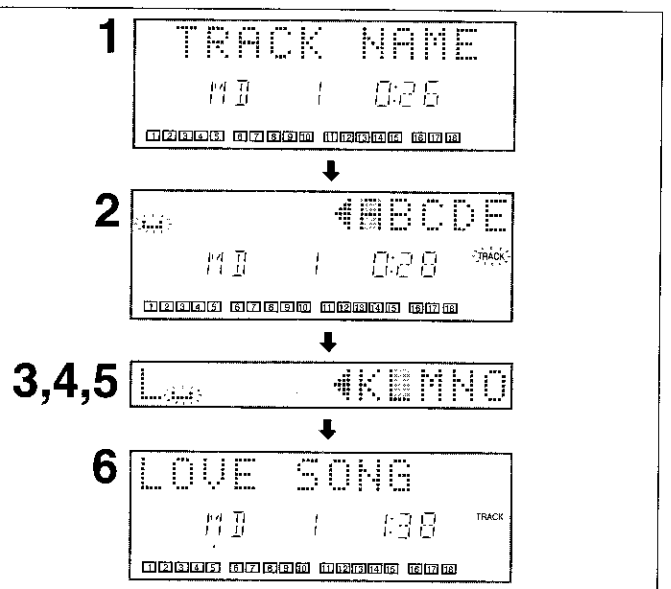
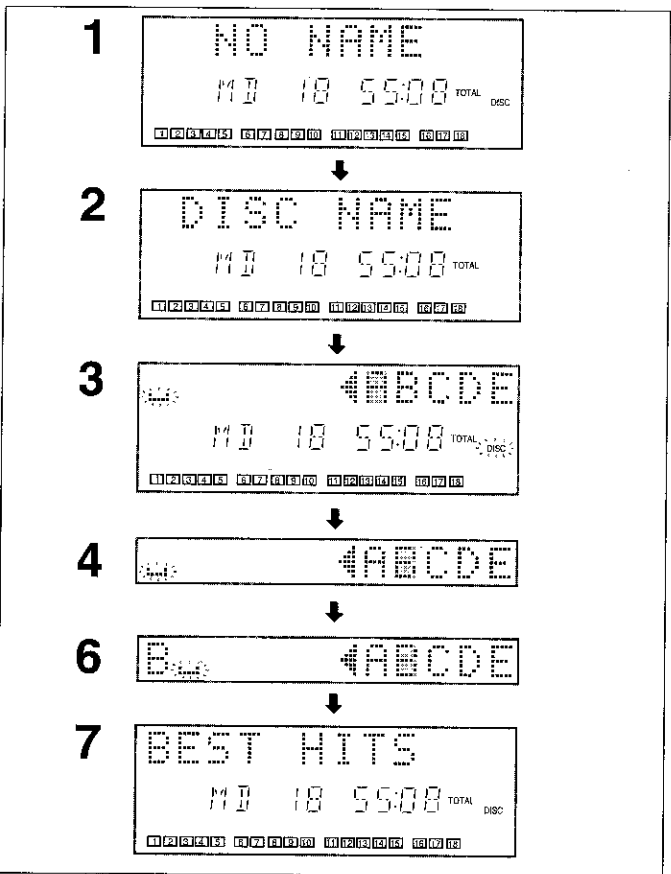
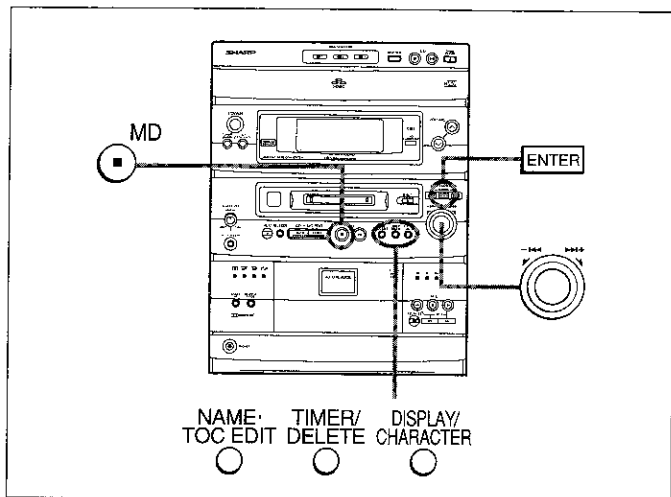

To create a disc name

Main Unit operation

Create name for the whole disc. The disc name is displayed when an MD is inserted.

- 1 Press the MD button.
 - The total number of tracks and the total playing time for the MD will appear.
- 2 Press the NAME•TOC EDIT button, and then select "DISC NAME" using the jog dial.
- 3 Within 10 seconds, press the ENTER button.
 - The unit will enter character input mode.
- 4 Press the DISPLAY/CHARACTER button to select the type of characters you want to use. (Page 31)
- 5 Select the character you wish using the jog dial.
- 6 Press the ENTER button to enter the character.
 - Repeat steps 4 to 6 above to enter the characters of the name. When the next character's type is the same as the previous character, step 4 can be skipped.
- 7 After entering all of the characters in the name, press the NAME•TOC EDIT button.
 - The disc name will be recorded.

Note:

- This function cannot be used whilst a programme is being entered ("PRGM" is lit) or whilst in random play mode ("RANDOM" is lit). First, cancel programme or random play mode before trying to use this function.

To create a track name

Main Unit operation

Name each track. The track's name will be displayed whenever you select it and during playback.

- 1 During playback, press the NAME•TOC EDIT button.
 - "TRACK NAME" will appear.
- 2 Within 10 seconds, press the ENTER button.
 - The unit will enter character input mode.
 - The track you are listening to will be played repeatedly.
- 3 Press the DISPLAY/CHARACTER button to select the type of characters. (Page 31)
- 4 Select the character you want using the jog dial.
- 5 Press the ENTER button to enter the character.
 - Repeat steps 3 to 5 above to enter characters in the name. When the next character's type is the same as the previous character, step 3 can be skipped.
- 6 After entering all of the characters in the name, press the NAME•TOC EDIT button.
 - The track name will be recorded.
 - The unit will return to normal playback.

Notes:

- This function cannot be used whilst a programme is being entered ("PRGM" is lit: Page 19) or whilst in random play mode ("RANDOM" is lit: Page 18). First, cancel programme or random play mode before trying to use this function.
- The track name function can be used whilst in stop mode (when selecting a track), in pause mode, or in recording mode. (Select "TRACK NAME" from the edit menu.)
- If you create a track name whilst recording the track, make sure you finish entering the name before you finish recording the track. If the end of the recording is reached before you have entered the complete name, only the characters entered before the recording ended will be recorded.

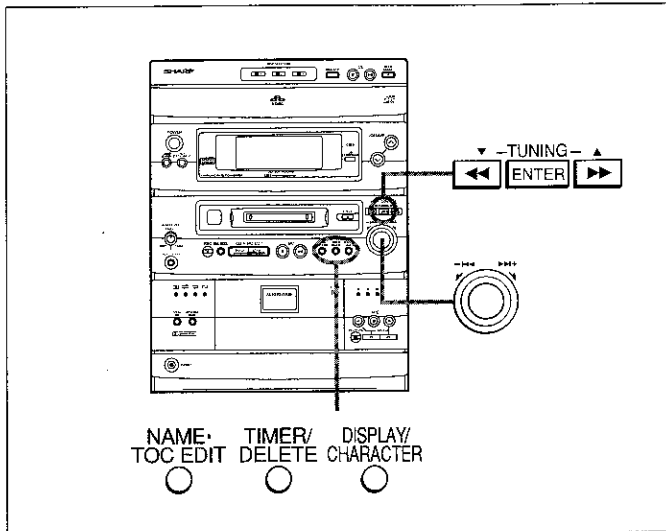

■ To change disc names and track names

Main Unit operation

To change disc names:

- 1 Press the MD ■ button.
- 2 Press the NAME•TOC EDIT button, and then select "DISC NAME" using the jog dial.
- 3 Within 10 seconds, press the ENTER button.
 - The unit will enter character input mode.
 - To cancel this operation, press the MD ■ button.
- 4 Now you can erase or add characters.

To change track names:

- 1 Whilst in stop mode, select the track name you wish to change, using the jog dial.
- 2 Press the NAME•TOC EDIT button.
- 3 Within 10 seconds, press the ENTER button.
 - The unit will enter character input mode.
 - To cancel this operation, press the MD ■ button.
- 4 Now you can erase or add characters.

■ To erase a character

Main Unit operation

After performing steps 1 to 3 mentioned above, do the following:
Example: To change "BESUT" to "BEST"

- 4 Press the ◀◀ or ▶▶ button to make the character you wish to erase begin flashing.
- 5 Press the TIMER/DELETE button.
 - The specified character will be erased.
- 6 Press the NAME•TOC EDIT button.

■ To add a character

Main Unit operation

After performing steps 1 to 3 mentioned above, do the following:
Example: To change "BST" to "BEST"

- 4 Press the ◀◀ or ▶▶ button to make the character at the position where you wish to add a character begin flashing.
- 5 Select the character you want to add, using the jog dial. Then, press the ENTER button.
- 6 Press the NAME•TOC EDIT button.

■ To erase disc names or track names

Main Unit operation

After performing steps 1 to 3 mentioned above, do the following:

- 4 Press the TIMER/DELETE button for at least 2 seconds.
 - The "NAME CLEAR?" display will appear.
- 5 Press the ENTER button.
 - The disc or track name will be erased.

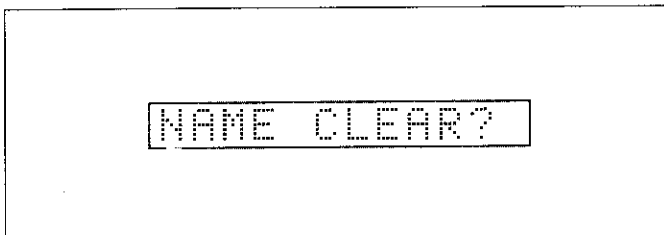

HOW TO USE THE BUILT-IN TIMER

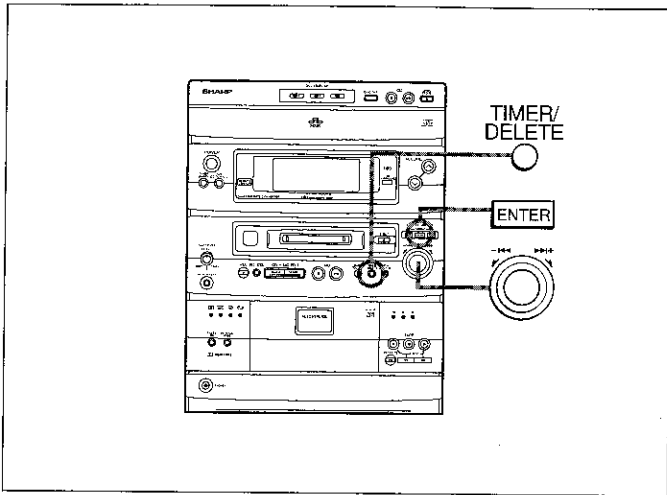

Main unit operation

- Before setting the timer, make sure that the clock setting is correct.
- The start time and stop time, which are set with this operation, will be kept in memory until the AC power lead is unplugged or the setting is changed.

The timer is set as follows.

STEP 1 Selecting the timer mode

Select timer playback or timer recording



STEP 2 Setting the timer

Set the start time and stop time for the timer



STEP 3 Using the timer

In our example, we selected timer mode and set the start time, and the stop time, as described in STEP 1 and STEP 2.

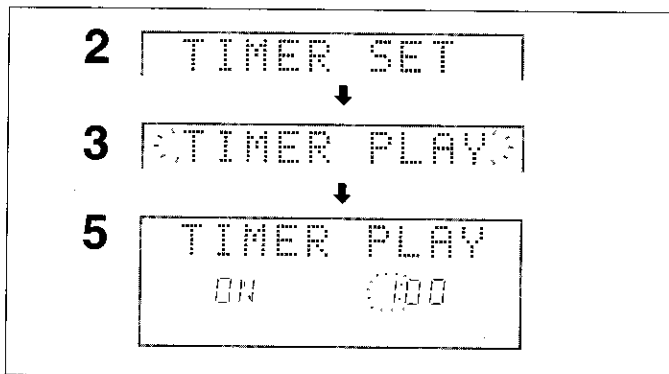

■ To select the timer mode (playback/recording) (STEP 1)

- 1 Whilst in stop mode, press the TIMER/DELETE button.
- 2 Turn the jog dial so that the TIMER SET display appears.
- 3 Within 10 seconds, press the ENTER button.
- 4 Select the timer mode using the jog dial.
- 5 Press the ENTER button.
 - The start time setting display will appear.

Go on to the next step.

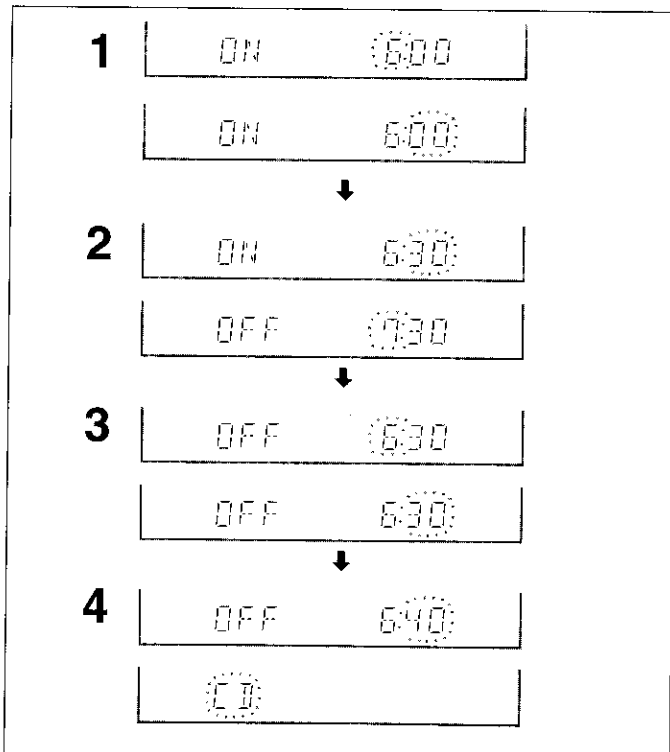

■ To set the start time and the stop time (STEP 2)

- 1 Enter the hour for the start time using the jog dial. Then, press the ENTER button.
- 2 Enter the minute using the jog dial. Then, press the ENTER button.
 - The stop time setting display will appear.
- 3 Enter the hour for the stop time using the jog dial. Then, press the ENTER button.
- 4 Enter the minute using the jog dial. Then, press the ENTER button.
 - The start and stop times are now set.

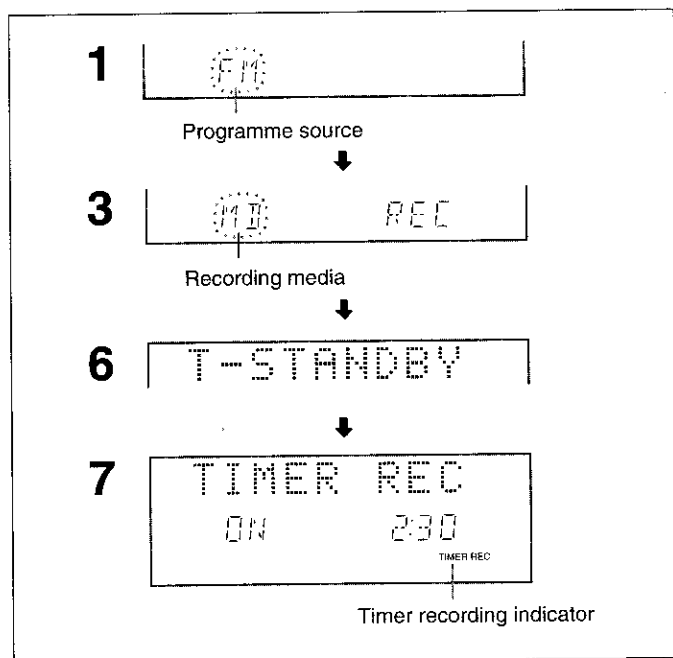
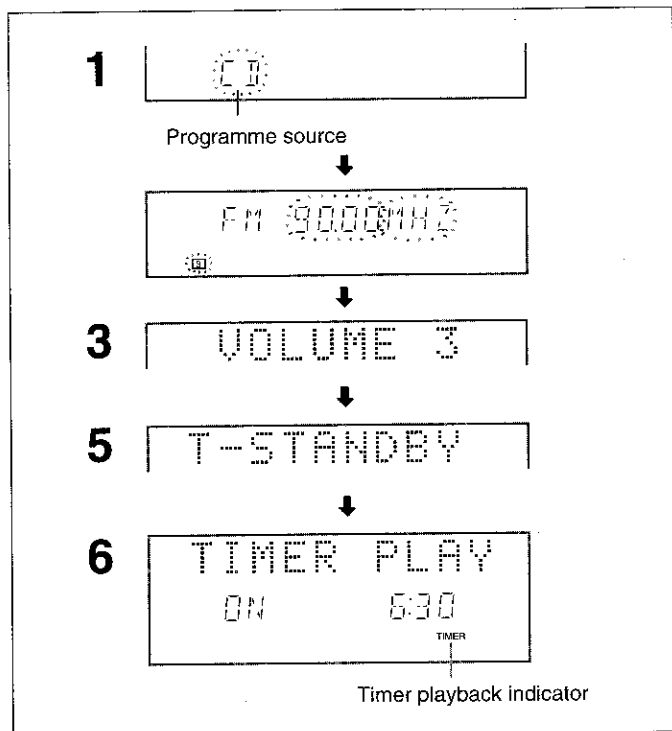

Set the timer so that timer playback or timer recording will begin at the time you wish (see previous page).
To use timer playback, perform STEP 3-A. To use timer recording, perform STEP 3-B.

■ To use the timer playback (STEP 3-A)

Before timer playback, the following preparations are required.

- Load a CD, MD or tape.
- Select a CD to be played.
- Preset the radio station.

1 Select the source programme using the jog dial.

- The source is selected in the following sequence:
CD→MD→TAPE→FM→AM→AUX (analogue)→AUX (digital)→CD
- If AM or FM is selected, press the ENTER button then select the preset number using the jog dial.

2 Press the ENTER button.

3 Adjust the sound level using the jog dial.

4 Press the ENTER button.

- Timer playback setting is complete.

5 Press the TIMER/DELETE button.

- Turn the jog dial so that the T-STANDBY display appears.
- If the start and stop time have not been set, the T-STANDBY display does not appear. Set the time.

6 Press the ENTER button.

- The settings will appear in order, and the unit will enter timer playback standby mode. (The power will be go off.)

■ To use timer recording (STEP 3-B)

Set the start and stop time for timer recording referring to STEP 1 and STEP 2. The difference is that you must turn the jog dial to show TIMER REC display in procedure 4 of STEP 1.

Before timer recording, the following preparations are required.

- Load a recordable MD or tape.
- To record onto a tape, select the tape direction and set the Dolby NR system.
- Preset the radio station.

1 Select the source programme using the jog dial.

- The source is selected in the following sequence:
FM → AM → AUX (analogue) → AUX (digital) → FM

- If AM or FM is selected, press the ENTER button then select the preset number using the jog dial.

2 Press the ENTER button.

3 Select the recording medium (MD or tape) using the jog dial, then press the ENTER button.

4 Adjust the sound level using the jog dial.

5 Press the ENTER button.

- Setting of timer recording is complete.

6 Press the TIMER/DELETE button.

- Turn the jog dial so that the T-STANDBY display appears.
- If the start and stop time have not been set, the T-STANDBY display does not appear. Set the time.

7 Press the ENTER button.

- The settings will appear in order, and the unit will enter timer recording standby mode. (The power will go off.)

To cancel timer setting

Press any button other than the jog dial or the ENTER button.

Notes

- When the CD, MD or tape is played to the end, playback will stop before the stop time.
If you wish to play to the stop time, set repeat play for the CD or MD, or select  for tape playback.
- Timer playback and timer recording with this unit cannot be used to control equipment connected to this unit. You must use the timer of the other equipment, if it has one.
- The timer playback and timer recording functions cannot be used at the same time.

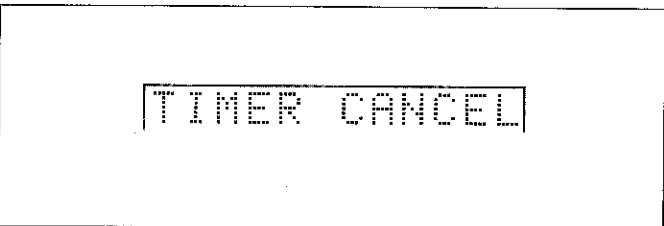
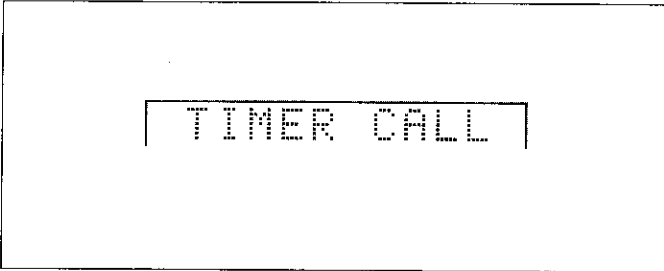

In the following cases, the timer recording function will not work

- When a MiniDisc has not been inserted
- When a playback-only MiniDisc is inserted
- When the MiniDisc you inserted is protected against accidental erasure
- When there is no recording space left on the MiniDisc you have inserted (when the "TOC FULL" or "DISC FULL" messages appear)

■ To check the timer setting

- 1 Whilst in timer standby mode, press the TIMER/DELETE button.
 - 2 Turn the jog dial so that the TIMER CALL display appears.
 - 3 Within 10 seconds, press the ENTER button.
- The timer settings will appear in order, and then the original display will reappear.

■ To cancel the timer operation

If the power is turned on, the timer will be cancelled.
The timer operation can also be cancelled as follows.

- 1 Whilst in timer standby mode, press the TIMER/DELETE button.
 - 2 Turn the jog dial so that the TIMER CANCEL display appears.
 - 3 Within 10 seconds, press the ENTER button.
- The timer operation will be cancelled. ("TIMER" or "TIMER REC" will go off.) The start and stop times will be stored.

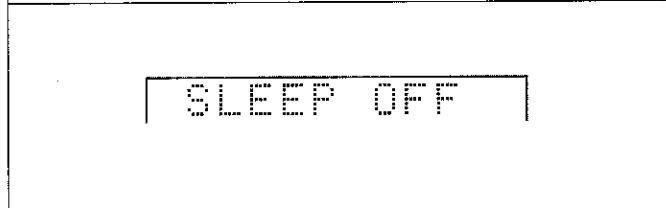
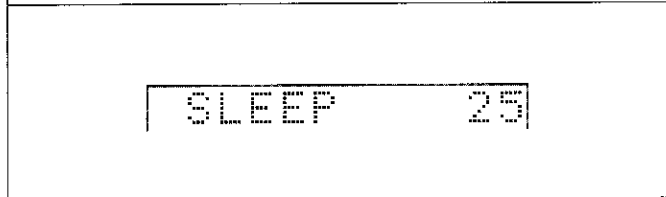
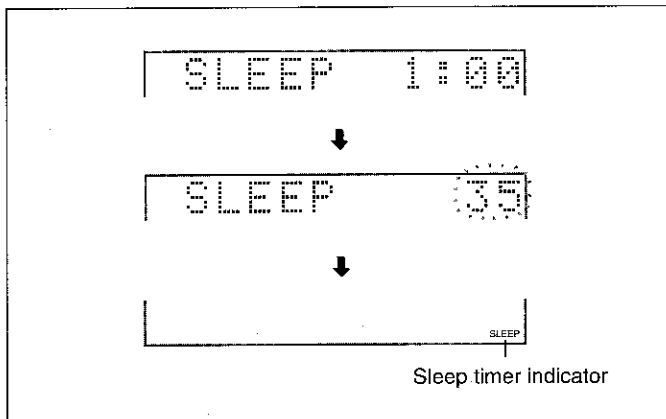
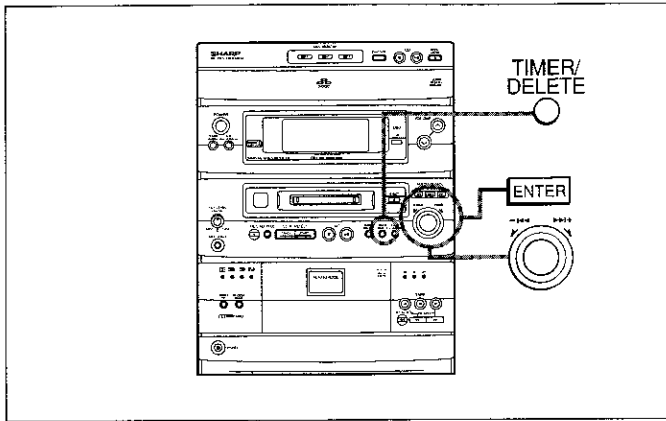

■ Sleep operation

The radio, compact disc, MiniDisc and cassette deck can all be turned off automatically.

- 1 Play the desired sound source.
 - 2 Press the TIMER/DELETE button.
 - 3 Turn the jog dial so that the SLEEP display and setting time appear.
 - 4 Within 10 seconds, press the ENTER button.
 - 5 If you wish to use the displayed time, press the ENTER button.
- The unit will turn off automatically after the preset sleep time has elapsed.

To change the sleep timer:

- 1 The SLEEP display and setting time must be displayed as in step 4 above.
 - 2 Set the sleep time using the jog dial.
- The setting time is changed in 5-minute increments between 2 hours and 5 minutes, or 1 minute increments between 5 minutes and 1 minute.
- 3 Press the ENTER button.

Notes:

- Once the sleep time is set, it will remain the same until the setting is changed.
- This sleep functions of this unit cannot be used to control equipment connected to this unit. You must use the sleep functions of the other equipment, if it has them.

To confirm the sleep timer setting:

- 1 Press the TIMER/DELETE button.
- 2 Turn the jog dial so that the SLEEP display and setting time appear.

To cancel the sleep operation:

If the power is turned on, the sleep operation will be cancelled. The timer operation can also be cancelled as follows if the power cannot be turned off during recording.

- 1 Press the TIMER/DELETE button.
 - 2 Turn the jog dial so that the SLEEP OFF display appears.
 - 3 Within 10 seconds, press the ENTER button.
- The sleep operation will be cancelled. ("SLEEP" will go off.)

■ Simultaneous sleep and timer operation

- 1 Play the desired item (compact disc, tape, etc.).
 - 2 Set the sleep timer.
 - 3 Set timer playback.
- When the preset sleep time has elapsed, the power will be automatically turned off. When the timer start time is reached, the power will be turned on again.

Caution:

- Pay attention to the length of the tape. When you want to go to sleep and wake up listening to a tape, if the length of the tape is shorter than the sleep time, timer playback will not be possible. In this case, set the reverse mode position to "⊞".

USING EXTERNAL UNITS

■ Connecting external units

Before connecting external units, turn the power of this unit and external units off.

Connecting a digital unit

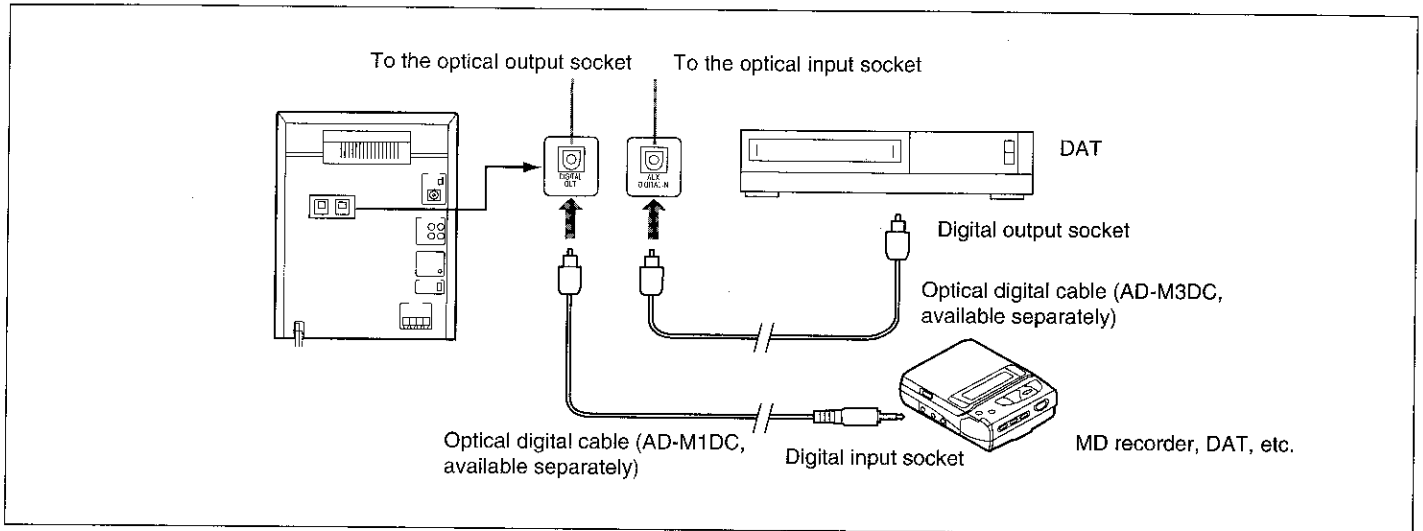

Connecting an analogue unit

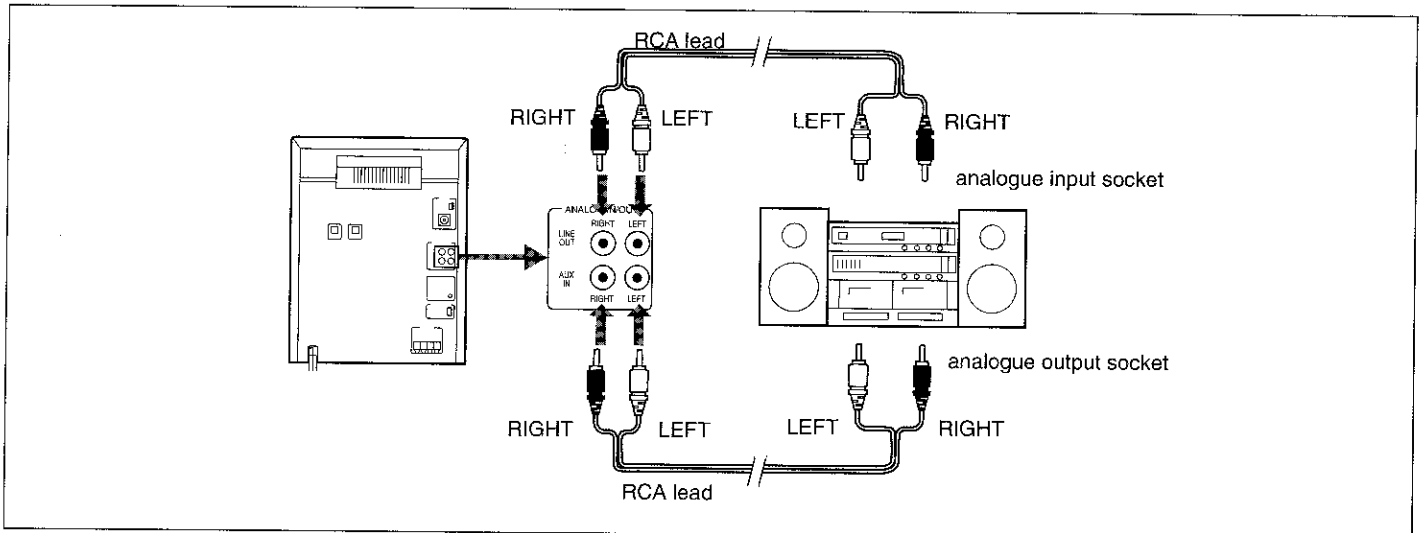

Notes

- When audio input and output signals of an external unit are connected to this unit, oscillation may occur. In such a case, disconnect either the input or output connection.
- When FM or AM is selected as a signal source, a digital signal is not output from this unit.
- If external equipment is connected to the AUX (STEREO) socket on the front panel, that equipment has priority over the other equipment.

■ Headphones

- Be sure that your headphones have a 3.5 mm (1/8") diameter plug and between 16 ohms and 50 ohms impedance. The recommended impedance is 32 ohms.
- When headphones are connected, the speakers are disabled automatically. Adjust the VOLUME control for the desired volume.

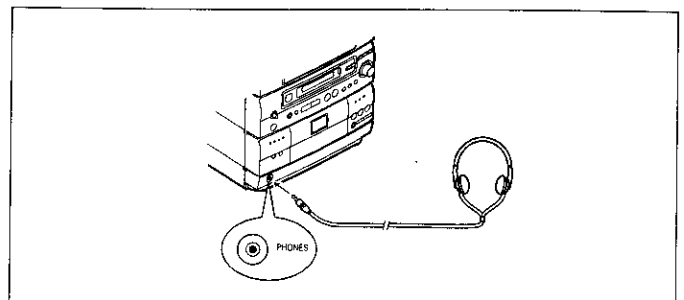

(Continued)

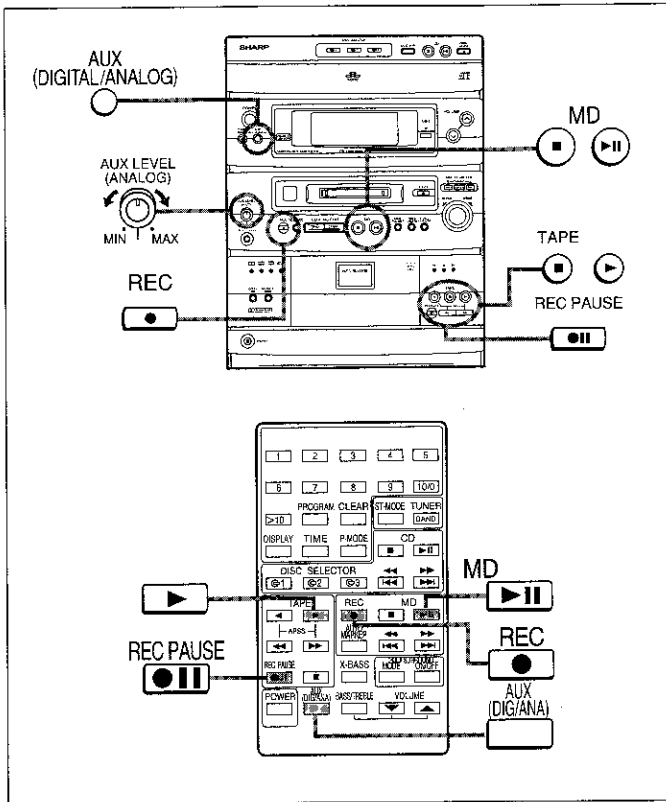

Digital sound

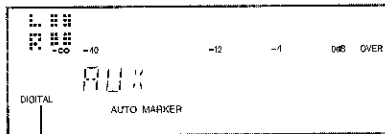

The DIGITAL indicator lights up.

Analogue sound

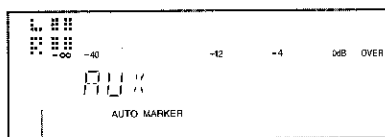

The DIGITAL indicator goes out.

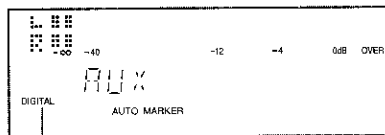

The DIGITAL indicator lights up for recording digital sound.

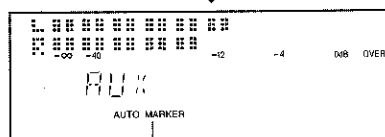

This indicator goes out when a tape is played back.

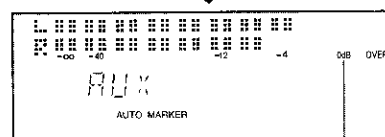

0 dB

Listening to sound from an external unit

To listen to digital sound

- 1 Press the AUX (DIGITAL/ANALOG) button so that the DIGITAL display appears.
- 2 Start playback on the external unit.
- 3 Adjust the sound level using the VOLUME buttons of this unit.

To listen to analogue sound

- 1 Press the AUX (DIGITAL/ANALOG) button so that the DIGITAL display does not appear.
- 2 Adjust the input sound level using the AUX LEVEL control.
 - When the AUX LEVEL control is set to MIN, no sound is obtained.
- 3 Start playback on the external unit.
- 4 Adjust the volume using the AUX LEVEL control and VOLUME buttons on this unit.

Recording sound from an external unit

- 1 Press the AUX (DIGITAL/ANALOG) button to select the auxiliary input, digital or analogue.
- 2 Load a recordable MiniDisc or cassette tape.
- 3 Press the REC ● button to record onto a MiniDisc, or the REC PAUSE ●|| button to record onto a cassette tape.
- 4 Start playback on the external unit.
- 5 Adjust the recording level using the AUX LEVEL control when analogue signals are to be recorded.
 - This step is required only for recording analogue signals.
 - The maximum level should not exceed 0 dB
- 6 Start recording by pressing the MD ►|| button to record onto a MiniDisc or the ► button to record onto a cassette tape.

Track Number for recording onto a MiniDisc

When digital sound such as a CD or a MiniDisc is recorded, the track number of the playback signal will be recorded as the track number.

In the case other than mentioned above, the track number is automatically recorded at the silent part of more than 1.5 seconds (auto marker function). If there is no silent part, it is considered as one track.

- If there is heavy noise, the track number may not be recorded.
- Recording without using the auto marker function is possible.

Note:

- On some CD players, the track numbers cannot be recorded automatically.

WHAT IS A MINIDISC?

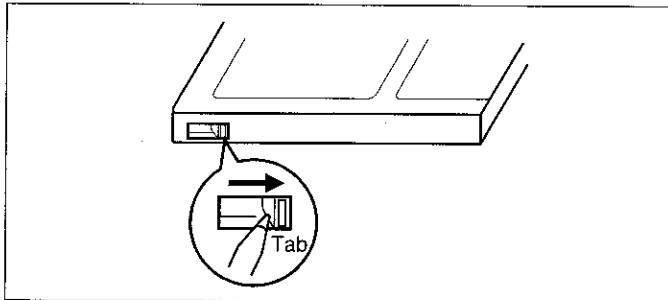
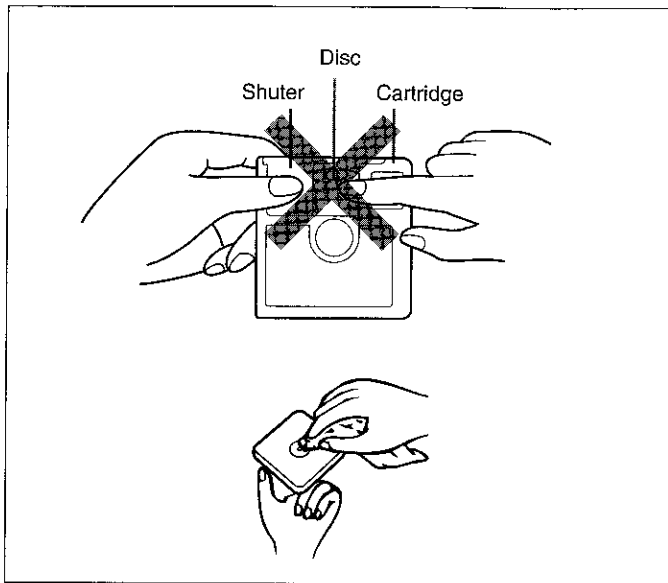

The disc is stored in a cartridge. You can handle it easily without worrying about dust, fingerprints, etc. However, dust entering the opening of the cartridge, dirt on the cartridge, etc. may cause malfunctions. Please note the following.

■ Handling MiniDiscs

Do not touch the disc directly!

Do not open the shutter or touch the disc directly. If the shutter is opened forcibly, it may break.

Where not to store discs:

Do not store discs in places with high temperatures or humidity. Specifically, do not leave discs in places exposed to direct sunlight or in cars with doors and windows closed. Do not leave discs in places where sand can get into the cartridge easily (e.g., a beach).

Regular cleaning:

If the surface of the cartridge becomes dusty or dirty, clean it with a soft, dry cloth.

■ To prevent recorded discs from being erased accidentally (accidental erasure prevention)

Slide the accidental erasure prevention tab, located on the side of the disc, in the direction indicated by the arrow.

- The disc will then be protected against accidental erasure.
- To add a recording to such a disc, slide the accidental erasure prevention tab back to its original position.

■ What is a MiniDisc?

- A MiniDisc is a 64 mm (2-1/2") diameter disc which is stored in a cartridge. MiniDisc are easy to handle, compared with compact discs, because they are protected against dust and scratches.
- Recording and playback use a digital system with a sound quality that is similar to that with compact discs.
MiniDiscs cannot twist or stretch like tapes. The quality of sound will not deteriorate. MiniDiscs are extremely durable.
- Never disassemble a MiniDisc.

■ Adaptive TTransform Acoustic Coding [ATRAC]

ATRAC (Adaptive TTransform Acoustic Coding) is a new technology that is designed to eliminate the information in sounds which you can not hear and to compress the remaining sound data so that the recording uses about 1/5 of the original sound information.

Sound data is analyzed and filtered to take advantage of psycho acoustic masking. The acoustic quality of the sound is not impaired.

(Continued)

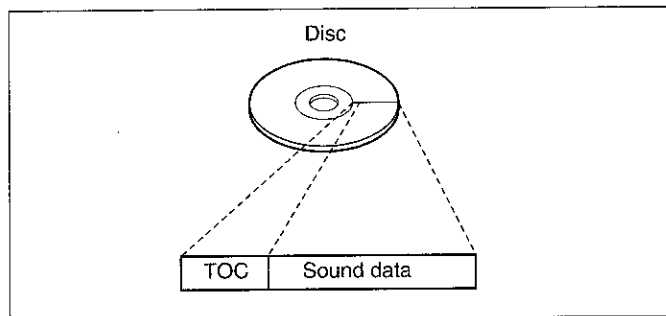
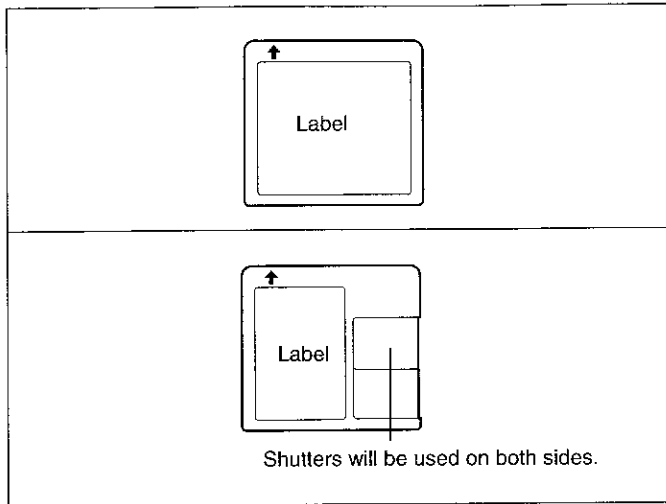

Types of discs

There are two types of MiniDiscs: playback-only and recordable type.

● Playback-only MiniDisc:

This type of MiniDisc is used for commercially available pre-recorded music. This is the same kind of optical disc as a CD. Playback is performed using an optical pickup. (Recording and editing are not possible.)

A shutter will be used on only one side (back).

● Recordable MiniDisc:

This is a "blank disc" on which recording can be performed. A magneto optical disc is used.

Recordings are made using a laser and a magnet. Repeated recording is possible.

High-speed access

A unique feature of the MiniDisc is the ability to locate the beginning of a desired track at high speed.

This is because the track number and track name data are stored in a TOC (Table of Contents).

Shock-Resistant Memory

During playback, approximately 10 seconds of information is stored in the semiconductor memory. Therefore, even when the pickup cannot read information for a second or two because of external shock, the sound continues without interruption because the information stored in memory is output.

MINIDISC SYSTEM LIMITATIONS

Even if the maximum recording time of a MiniDisc is not been reached, "DISC FULL" or "TOC FULL" may be displayed.

When the number of tracks used reaches the limit, regardless of the remainder recording time, further recording will be impossible. (Maximum number of tracks: 254)

Even if the number of tracks and the recording time have not reached the limit, "DISC FULL" may be displayed.

When emphasis information (equalizer treatment in the treble section) in a track switches on/off many times, each change is assumed to be the beginning of a new track, which will quickly use up all available track numbers, making further recording impossible, regardless of the remaining time, recording time or the number of tracks on the original.

Even if several short tracks are erased, the remaining recording time may not show an increase.

When the remaining recording time of a disc is displayed, short tracks less than 12 seconds long may not be included in the total.

Two tracks may not be combined in editing.

For MiniDiscs on which repeated recording and editing operations were performed, the COMBINE function may not work.

The total of the recorded time and time remaining on a disc may not add up to the maximum possible recording time.

A cluster (about 2 seconds) is normally the minimum unit of recording. So, even if a track is less than 2 seconds long, it will use about 2 seconds of space on the disc. Therefore, the time actually available for recording may be less than the remaining time displayed.

If there are scratches on a disc, those sections will be automatically avoided (no recording will be placed in those sections). Therefore, recording time will be reduced.

TROUBLE SHOOTING

■ If a problem occurs

If this unit functions abnormally during operation, first check the following items. If the unit continues to function abnormally, or if an abnormality appears other than listed below, turn off the player's power and disconnect the AC power plug, then consult your SHARP dealer or service personnel.

General

SYMPTOM	POSSIBLE CAUSE	REMEDY
• The clock is wrong.	• Did a power failure occur?	• Try setting it again.
• When a button is pressed, the unit does not respond.	—	• Turn the power off and on again, and then retry the operation.
• No sound is heard.	• Are the speaker leads disconnected? • Are the leads of the speaker lead shorted? • Is the volume level is set to "0"? • Are the headphones connected?	• Connect the leads securely. • Disconnect the AC power lead, and connect it again. • Increase the volume level. • Disconnect the headphones.
• Radios make unusual noise or the picture on the TV screen is distorted.	• When a radio or TV which uses an indoor aerial is placed near the unit, the picture on the TV screen may be distorted or the radio may not function properly.	• It is recommended that you use an external aerial.

CD playback

SYMPTOM	POSSIBLE CAUSE	REMEDY
• Even though a disc has been loaded, "NO DISC" or "ERROR" is displayed.	• The disc is loaded up-side down. • The disc is very dirty.	• Load the disc with the correct side up. • Clean the disc.
• Playback stops in the middle of a track, or playback is not performed properly.	• The disc which does not satisfy the standards. • Is the unit located near excessive vibrations?	• Load the correct disc. • Place the unit on a firm, level surface free from vibration.
• Playback sounds are skipped.	• Has condensation formed inside the unit?	• Remove the disc and leave the power turned on. The unit should function properly in about 1 hour.

MD recording and playback

SYMPTOM	POSSIBLE CAUSE	REMEDY
• A recording cannot be made.	• Is the MiniDisc protected against accidental erasure? • Did you try to make recording on a playback-only MiniDisc? • Can you see the "TOC FULL" message in the display?	• Slide the accidental erase prevention tab back to its original position. • Replace it with a recordable disc. • Put in another recordable disc with recording space on it.
• Even though a disc has been loaded, "NO DISC" or "ERROR" is displayed.	• The disc is very dirty. • Is the unit located near excessive vibrations?	• Clean the disc. • Place the unit on a firm, level surface free from vibration.
• Playback sounds are skipped.	• Has condensation formed inside the unit?	• Remove the disc and leave the power turned on. The unit should function properly in about 1 hour.

Tape recording and playback

SYMPTOM	POSSIBLE CAUSE	REMEDY
• A recording cannot be made.	• Is the tape protected against accidental erasure?	• Cover the accidental erase prevention hole.
• Sound is skipped.	• The tape is wrinkled.	• Replace the tape.
• Sound in high-frequency range cannot be reproduced.	• The capstan and pinch roller are very dirty.	• Clean the capstan and pinch roller.
• Sound quivers.		
The cassette cannot be ejected.	• Did a power failure occur?	• Wait until the power is supplied.

Radio Reception

SYMPTOM	POSSIBLE CAUSE	REMEDY
• Radios make unusual noise consecutively.	• The unit is placed near the TV or computer. • The aerial direction is not placed properly.	• Place the unit apart from the noise. • Correct the aerial direction.
• The preset channel cannot be called.	• Did a power failure occur?	• Preset the channel again.

Remote control

SYMPTOM	POSSIBLE CAUSE	REMEDY
• The remote control does not function or does not operate properly.	• The batteries (polarity) are not inserted properly. • The batteries inside the remote control are dead. • The remote control is operated from an incorrect distance or angle.	• Insert properly. • Replace the batteries. • Operate it within a range of 0.2 m (8") to 6 m (20') and within an angle of 15° to either side of centre.
• The power cannot be turned on from the remote control.	• Is the AC power lead plugged in?	• Connect the AC power lead.

■ Moisture condensation

In the following cases, condensation may form inside the unit.

- Shortly after turning on a heater.
- When the unit is placed in a room where there is excessive steam or moisture.
- When the unit is moved from a cool place to a warm place.

When the unit has condensation inside, the disc signals cannot be read, and the product may not function properly.

- If this happens, remove the disc. The condensation should evaporate in approximately 1 hour. The unit will then function properly.

■ If a problem occurs

If this product is subjected to strong external interference (mechanical shock, excessive static electricity, abnormal supply voltage due to lightning, etc.) or if it is operated incorrectly, it may malfunction or the display may not function correctly. If such a problem occurs, do the following:

- 1 Unplug the AC power lead from the AC socket.
 - 2 Press the RESET button on the back of the unit.
 - 3 Plug the AC power lead back into the AC socket.
- When the RESET button is pressed, all of the settings in memory will be erased.
 - If strange sounds, smells or smoke come out of the unit or if a foreign object falls into the unit, turn off the power, unplug the AC power lead from the AC socket, immediately. Contact the shop where you purchased the unit.

■ If a power failure occurs during recording

If the AC power plug is disconnected from the AC socket or a power failure occurs during recording (before the TOC information has been recorded on the disc), the audio portion being recorded at that time will be erased.

When a recording is being added to a MiniDisc which already has a recording on it, if the TOC is not updated before the power failure, the added recording will be erased.

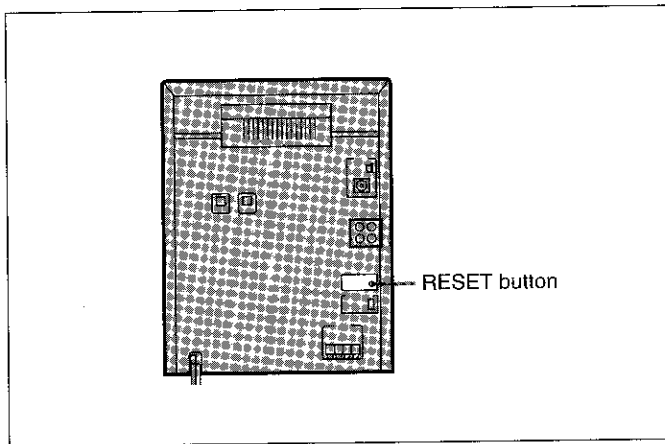

(Continued)

When an error message is displayed, proceed as follows:

Error messages	Meaning	Remedy
NO DISC	<ul style="list-style-type: none"> • A disc has not been loaded. • The disc data cannot be read. 	<ul style="list-style-type: none"> • Load a disc. • Reload the disc.
DISC ERR	<ul style="list-style-type: none"> • The disc is damaged or there is no TOC on the disc. 	<ul style="list-style-type: none"> • Reload the disc or replace it.
BLANK MD	<ul style="list-style-type: none"> • Nothing is recorded. 	<ul style="list-style-type: none"> • Replace the disc with a recorded disc.
0 00:00	<ul style="list-style-type: none"> • Music is not being recorded. 	<ul style="list-style-type: none"> • Replace the disc with a recorded disc.
EDIT OVER	<ul style="list-style-type: none"> • There is no space left for recording CD. 	<ul style="list-style-type: none"> • Replace it with another recordable disc.
? DISC	<ul style="list-style-type: none"> • The data contains an error. 	<ul style="list-style-type: none"> • Replace the disc with another disc.
TOC ERR*	<ul style="list-style-type: none"> • The disc has a large amount of damage. 	<ul style="list-style-type: none"> • Replace the disc with another disc.
DISC FULL	<ul style="list-style-type: none"> • The disc is out of recording space. 	<ul style="list-style-type: none"> • Replace the disc with another recordable disc.
PLAYBACK MD	<ul style="list-style-type: none"> • You tried to record on a playback-only disc. 	<ul style="list-style-type: none"> • Replace it with a recordable disc.
PROTECTED	<ul style="list-style-type: none"> • The disc is write protected. 	<ul style="list-style-type: none"> • Move the write protection tab back to its original position.
TOC FULL*	<ul style="list-style-type: none"> • There is no space left for recording character information (track names, disc names, etc.) 	<ul style="list-style-type: none"> • Replace it with another recordable disc.
Can't REC	<ul style="list-style-type: none"> • Recording cannot be performed correctly due to vibration or shock in the unit. 	<ul style="list-style-type: none"> • Rerecord or replace it.
Din UNLOCK	<ul style="list-style-type: none"> • Incorrect digital signals are input. 	<ul style="list-style-type: none"> • Connect correct digital signals.
Can't COPY	<ul style="list-style-type: none"> • No copy can be made because of the SCMS copyright system. 	<ul style="list-style-type: none"> • Record using the analogue cable.
Can't EDIT	<ul style="list-style-type: none"> • A track cannot be edited. 	<ul style="list-style-type: none"> • Change the stop position of the track and then try editing it.
TEMP OVER	<ul style="list-style-type: none"> • The temperature is too high. 	<ul style="list-style-type: none"> • Turn off the power, and wait for a whilst.
DEFECT	<ul style="list-style-type: none"> • Since this disc has scratches on it, the recording operation was skipped. 	<ul style="list-style-type: none"> • Replace the disc with another recordable disc.
NAME FULL	<ul style="list-style-type: none"> • The number of characters for the disc name or track name exceeds 40. 	<ul style="list-style-type: none"> • Shorten the disc or track name.
MECHA ERR*	<ul style="list-style-type: none"> • There is a mechanical problem and the disc is not working properly. 	<ul style="list-style-type: none"> • Turn off the power, and press the EJECT button.
NOT AUDIO	<ul style="list-style-type: none"> • The data recorded on this disc is not audio data. 	<ul style="list-style-type: none"> • Select another track. • Replace the disc.
U TOC W ERR	<ul style="list-style-type: none"> • The TOC information could not be created properly due to a mechanical shock or to scratches on the disc. 	<ul style="list-style-type: none"> • Turn off the power, and try to write the TOC again. (Remove any source of shock or vibration whilst writing.)
U TOC ERR*	<ul style="list-style-type: none"> • The TOC information on this disc does not meet the MD specifications or it cannot be read. 	<ul style="list-style-type: none"> • Replace it with another disc. • Erase all the data, and try recording.

*: Number or symbol

MAINTENANCE

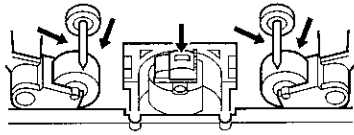

Internal care

- Dirty heads, capstans or pinch rollers can cause poor sound and tape jams. Clean these parts with a cotton swab moistened with commercial head/pinch roller cleaner or isopropyl alcohol.
- After long use, the deck's heads and capstans may become magnetised, causing poor sound. Demagnetise these parts once every 30 hours of playing/recording time by using a commercial tape head demagnetiser. Read the demagnetiser's instructions carefully before use.

External care

- Periodically wipe the cabinet with a soft cloth and dilute soap solution, then wipe with a dry cloth.
- Do not use chemically treated cleaning cloths or other chemicals.

SPECIFICATIONS

As a part of our policy of continuous improvement, SHARP reserves the right to make design and specification changes for product improvement without prior notice. The performance specification figures indicated are nominal values of production units. There may be some deviations from these values in individual units.

Main unit section

(MiniDisc recorder)

Type:	MiniDisc recorder
Signal readout:	Non-contact, 3-beam semi-conductor laser pick-up
Audio channels:	Stereo 2 channels/monaural (long-play mode) 1 channel
Frequency response:	20 - 20,000 Hz (+1/-3 dB)
Rotation speed:	400 - 900 rpm CLV, Approx.
Quantization:	16-bit linear
Filter:	8-times oversampling digital filter
Error correction:	ACIRC (Advanced Cross Interleave Reed-Solomon Code)
Coding:	ATRAC (Adaptive Transformed Acoustic Coding)
Recording method:	Magnetic modulation overwrite method
D/A converter:	1-bit
Sampling frequency:	44.1 kHz
Wow and flutter:	Unmeasurable (less than 0.001% W. peak)
Signal/noise ratio:	95 dB (1 kHz)
Dynamic range:	90 dB (1 kHz)
T. H. D at 1 kHz:	0.1%

(Compact disc player)

Type:	3 disc multi-play compact disc player
Signal readout:	Non-contact, 3-beam semi-conductor laser pickup
Rotational speed:	200 - 500 rpm CLV, Approx.
Error correction:	CIRC (Cross Interleave Reed-Solomon Code)
Quantization:	16-bit linear
D/A converter:	1-bit
Filter:	8-times oversampling digital filter
Frequency response:	20 - 20,000 Hz (+1/-3 dB)
Signal/noise ratio:	95 dB (1 kHz)
Dynamic range:	90 dB (1 kHz)
Wow and flutter:	Unmeasurable (less than 0.001% W. peak)

(Tuner)

Frequency range:	FM; 87.5 - 108 MHz AM; 522 - 1,620 kHz
Sensitivity:	FM; 2.5 μ V (75 ohms, unbalanced) AM; 650 μ V/m

(Tape deck)

Tape:	Compact cassette tape
Frequency response:	50 - 14,000 Hz (Normal tape) 50 - 15,000 Hz (CrO ₂ tape)
Motor:	DC motor with electronic governor \times 1
Signal/noise ratio:	50 dB (recording/playback)
Bias and erasure system:	AC
Head:	Playback/recording \times 1 Erase \times 1
Wow and flutter:	0.15 % (WRMS)

(General)

Power source:	AC 230 V, 50 Hz
Power consumption:	250 W
Output power:	RMS; 100 W (50 W + 50 W) (10% T.H.D.)
Input terminals:	AUX (analogue); 200 mV/47 kohms AUX (optical/digital)
Output terminals:	Headphones; 16- 50 ohms (recommended; 32 ohms) Speakers; 8 ohms AUX (Analogue); 2.0 V (1 kohm) AUX (Optical/digital)
Dimensions:	Width; 270 mm (10-11/16") Height; 351 mm (13-7/8") Depth; 332 mm (13-1/8")
Weight:	9.8 kg (21.6 lbs.)

Speaker section

Type:	2-way 130 mm (5") woofer and 65 mm (2-1/2") tweeter type
Maximum input power:	100 W
Rated input power:	50 W
Impedance:	8 ohms
Dimensions:	Width; 210 mm (8-5/16") Height; 351 mm (13-7/8") Depth; 268 mm (12-1/8")
Weight:	4.9 kg (10.8 lbs./each)

MEMO

TERMS OF GUARANTEE

Sharp Electronics (UK) Ltd. ("Sharp") guarantees to provide for the repair, or at its option the replacement, of this product subject to the conditions listed below:-

1. This guarantee shall only apply to faults which are due to inferior workmanship or materials. It does not cover faults or damage caused by accident, misuse, fair wear and tear, neglect, tampering with the product, or repair other than by a Service Facility appointed by Sharp.
2. As this product is intended for private domestic use only, the guarantee will not apply if the product is used in the course of a business, trade or profession.
3. To benefit from this guarantee, any fault which occurs must be notified to Sharp, or its appointed Service Facility within one year from the date this product was purchased. Proof of purchase must be provided.
4. The guarantee does not cover carriage costs, jewelled styli, audio tapes, compact discs or batteries.
5. In the unlikely event of this product requiring repair, please contact the supplier from whom it was purchased. Where this is not possible, please contact the Sharp Customer Information Centre on the telephone number given below.
6. No person has any authority to vary the terms or conditions of this guarantee.
7. This guarantee is offered as an additional benefit to your statutory rights, and does not affect these rights in any way.

If you have any difficulty operating this product, or would like information on other Sharp products, please telephone the Sharp Customer Information Centre on the number given below.

Sharp Customer Information Centre - Telephone LoCall 0345 125387

Please note that all calls are charged at local rate.

SHARP

SHARP ELECTRONICS (U.K.) LTD.

Sharp House, Thorp Road, Newton Heath, Manchester, M40 5BE

SHARP CORPORATION