

SHARP

MD STUDIO
MD STUDIO
MD STUDIO
MD STUDIO

MODEL
MODELL
MODÈLE
MODELO

MD-ZV30H

OPERATION MANUAL MODE D'EMPLOI
BEDIENUNGSANLEITUNG MANUAL DE MANEJO

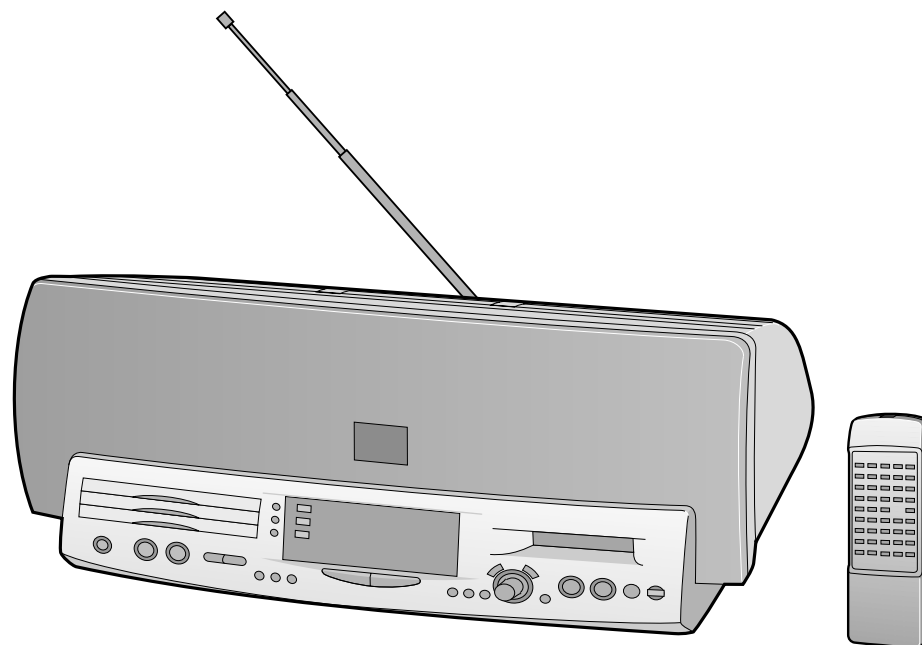

ENGLISH



DEUTSCH

FRANÇAIS

ESPAÑOL

SPECIAL NOTES FOR UK CUSTOMERS ONLY

NOTE FOR USERS IN THE U.K.

The mains lead of this product is fitted with a non-rewireable (moulded) plug incorporating a 3A fuse. Should the fuse need to be replaced, a BSI or ASTA approved BS 1362 fuse marked  or  and of the same rating as above, which is also indicated on the pin face of the plug must be used.

Always refit the fuse cover after replacing the fuse. Never use the plug without the fuse cover fitted.

In the unlikely event of the socket outlet in your home not being compatible with the plug supplied, cut-off the mains plug and fit an appropriate type.

DANGER:

The fuse from the cut-off plug should be removed and the cut-off plug destroyed immediately and disposed of in a safe manner.

Under no circumstances should the cut-off plug be inserted elsewhere into a 13A socket outlet as a serious electric shock may occur.

To fit an appropriate plug to the mains lead, follow the instructions below:

IMPORTANT:

The wires in the mains lead are coloured in accordance with the following code:

Blue : Neutral
Brown : Live

As the colours of the wires in the mains lead of this product may not correspond with the coloured markings identifying the terminals in your plug, proceed as follows:

- The wire which is coloured blue must be connected to the plug terminal which is marked N or coloured black.
- The wire which is coloured brown must be connected to the plug terminal which is marked L or coloured red.

Ensure that neither the brown nor the blue wire is connected to the earth terminal in your three pin plug.

Before replacing the plug cover, make sure that:

- If the new fitted plug contains a fuse, its value is the same as that removed from the cut-off plug.
- The cord grip is clamped over the sheath of the mains lead and not simply over the lead wires.

IF YOU HAVE ANY DOUBT, CONSULT A QUALIFIED ELECTRICIAN.

SERVICE INFORMATION

In the unlikely event of your equipment requiring repair, please contact the dealer or supplier from whom it was purchased. Where this is not possible, please contact the telephone number listed below. You will then be given details of how to obtain service.

0345-125387

Please note; all calls will be charged at local rate.

Certain replacement parts and accessories may be obtained from our main parts distributor, who can be contacted on the following numbers;
WILLOW VALE ELECTRONICS LTD.

MANCHESTER 0161-682-1415
READING 01734-876444

In the unlikely event of this equipment requiring repair during the guarantee period, you will need to provide proof of the date of purchase to the repairing company. Please keep your invoice or receipt, which is supplied at the time of purchase.

- Recording and playback of any material may require consent, which SHARP is unable to give. Please refer particularly to the provisions of the Copyright Act 1956, the Dramatic and Musical Performers Protection Act 1958, the Performers Protection Acts 1963 and 1972 and to any subsequent statutory enactments and orders.
- This equipment complies with the requirements of Directives 89/336/EEC and 73/23/EEC as amended by 93/68/EEC.
- SRS technology Licensed from SRS Labs. SRS technology holds the following patents: U.S. Patent No. 4,748,669 and U.S. Patent No. 4,841,572.
- **SRS**, the SRS Logo  and the **SOUND RETRIEVAL SYSTEM** are registered trademarks of SRS Labs, Inc. in the United States.

US and foreign patents licensed from Dolby Laboratories Licensing Corporation.

- When the ON/STAND-BY switch is set at STAND-BY position mains voltage is still present inside the unit. When the ON/STAND-BY switch is set at STAND-BY position and the clock is displayed, the unit may be brought into operation by the timer mode or remote control.

Warning:

This unit contains no user serviceable parts. Never remove covers unless qualified to do so. This unit contains dangerous voltages, always remove mains plug from the socket before any service operation and when not in use for a long period.

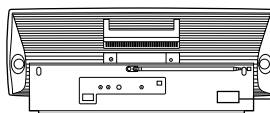

CLASS 1 LASER PRODUCT
APPAREIL À LASER DE CLASSE 1
PRODUCTO LASER DE CLASE 1

Caution:

Use the MD studio only in accordance with the instructions given in this manual and do not attempt to interfere with the interlock switch or make any other adjustment as this may result in exposure to hazardous radiation.

ENGLISH





INTRODUCTION

Thank you for purchasing this SHARP product.
To obtain the best performance from this product please read this manual carefully. It will guide you in operating your SHARP product.

CONTENTS

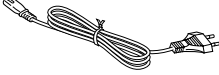
	Page		Page
ACCESSORIES	1	RECORDING	18-22
PRECAUTIONS	2	EDITING	23-32
NAMES OF CONTROLS AND INDICATORS	3	HOW TO USE THE BUILT-IN TIMER	33-35
REMOTE CONTROL	4-5	USING EXTERNAL UNITS	36-37
PREPARATION FOR USE	5	WHAT IS A MINIDISC?	38-39
SETTING THE CLOCK	6	MINIDISC SYSTEM LIMITATIONS	39
SOUND CONTROL	7-8	TROUBLESHOOTING	40-42
COMPACT DISC OPERATION	9-10	TRANSPORTING THE UNIT	42
MINIDISC OPERATION	11	MAINTENANCE	43
RADIO OPERATION	12-13	SPECIFICATIONS	43
CONVENIENT CD AND MD OPERATIONS	14-17		

ACCESSORIES

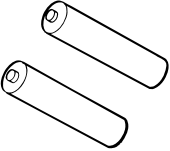
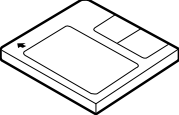
<ul style="list-style-type: none"> ● For European customers  <ul style="list-style-type: none"> ● For U.K. customers  <p>AC Power Lead × 1</p>	 <p>AM loop aerial × 1</p>	 <p>Remote control × 1</p>	 <p>"AA" size battery (UM/SUM-3, R6, HP-7 or similar) × 2</p>
 <p>Blank (Recordable) MiniDisc × 1</p>	<p>Note: Parts and equipment mentioned in this operation manual other than those shown above are not included.</p>		

PRECAUTIONS

General

- Please ensure that the equipment is positioned in a well ventilated area and ensure that there is at least 5 cm of free space along the sides, top and back of the equipment.
- Do not use oil, solvents, petrol, paint thinners or insecticides on the unit.
- Do not expose the unit to moisture, to temperatures higher than 60°C (140°F) or to extreme low temperatures.
- Keep the unit away from direct sunlight, strong magnetic fields, excessive dust, humidity and electronic/electrical equipment (home computers, facsimiles, etc.) which generates electrical noise.
- Hold the AC power plug by the head when removing it from the AC socket, since pulling the lead can damage internal wires.
- Remove the AC power plug from the wall socket before cleaning the heads, pinch rollers, etc. This unit contains dangerous voltages. Do not remove the outer cover, as this may result in electric shock. Refer internal service to your local SHARP service facility.
- Use the unit on a firm, level surface free from vibration, and do not place anything on the top of the unit.
- If the unit does not work properly whilst in use, set the ON/STAND-BY switch to STAND-BY, then disconnect the AC power lead from the AC socket. Plug the AC power lead back in, and then set the ON/STAND-BY switch to ON.
- If a lightning storm is taking place near you, it is suggested that you disconnect the AC power lead from the AC socket for safety.

Warning:

The voltage used must be the same as that specified on this unit. Using this product with a higher voltage than that which is specified is dangerous and may result in a fire or other type of accident causing damage. SHARP will not be held responsible for any damage resulting from use of this unit with a voltage other than that which is specified.

Volume control

It is advisable to avoid exposure to high volume levels, which occur whilst turning the unit on with the volume control setting up high, or whilst continually listening at high volumes.

Condensation

Sudden temperature changes, storage or operation in an extremely humid environment may cause condensation inside the cabinet (CD pickup, MD pickup, etc.) or on the transmitter window on the remote control.

Condensation can cause the unit to malfunction.

If this happens, leave the power on with no disc in the unit until normal playback is possible (about 1 hour) or wipe off any condensation on the transmitter window with a soft cloth before operating the unit.

Care of compact discs

Compact discs are fairly resistant to damage, however mistracking can occur due to an accumulation of dirt on the disc surface.

Follow the guidelines below for maximum enjoyment from your CD collection and player.

- Do not write on either side of the disc, particularly the non-label side. Signals are read from the non-label side. Do not mark this surface.
- Keep your discs away from direct sunlight, heat, and excessive moisture.
- Always hold the CDs by the edges. Fingerprints, dirt, or water on the CDs can cause noise or mistracking. If a CD is dirty or does not play properly, clean it with a soft, dry cloth, wiping straight out from the centre, along the radius.

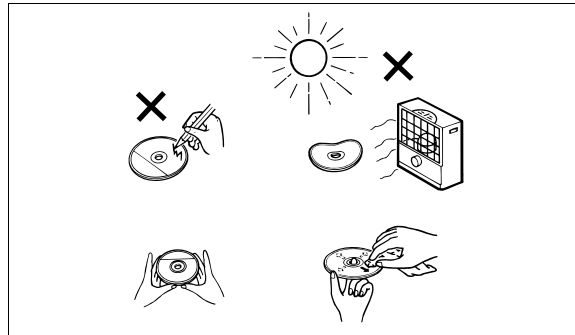

About the transport card

This unit is shipped with a transport card in place to prevent damage during shipping.

Before using, follow these steps to remove the transport card:

- 1 Set the ON/STAND-BY switch to ON.
- 2 Press the \blacktriangle button of the disc 1 to open the disc tray.
- 3 Remove the transport card.

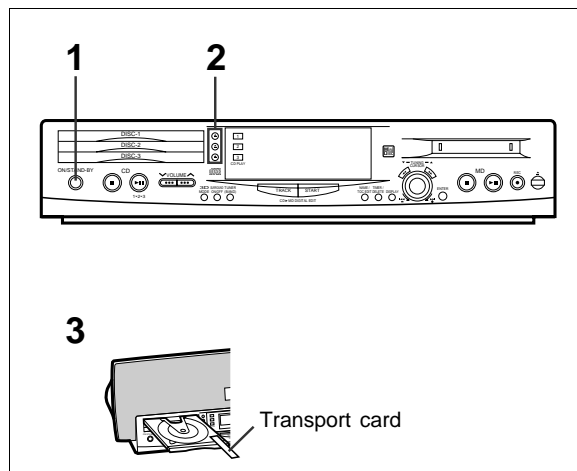

NAMES OF CONTROLS AND INDICATORS

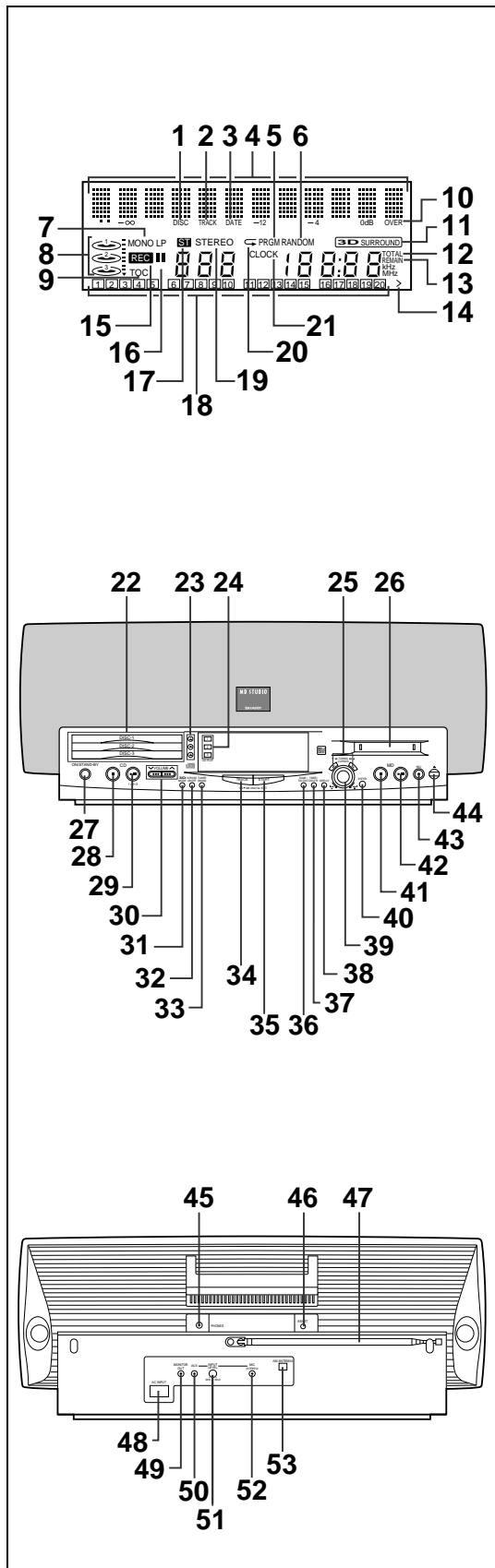

● Display window

1. Disc Name Indicator
2. Track Name Indicator
3. Date Indicator
4. Level Meter/Character Information Display
5. Programme Indicator
6. Random Play Indicator
7. Monaural Long-Play Mode Indicator
8. Disc Indicators
9. MD TOC Indicator
10. Recording Level Too High Indicator
11. 3D Surround Indicator
12. Total Time Indicator
13. Remaining Time Indicator
14. More Tracks Indicator
15. MD Record Indicator: REC
16. MD Pause Indicator: ||
17. FM Stereo Indicator: ST
18. Music Schedule/Preset Number Indicators
19. FM Stereo Mode Indicator
20. Repeat Indicator: □
21. Clock Indicator

22. CD Disc Trays
23. CD Eject Buttons
24. CD Play Buttons
25. Tuning/Cursor Buttons
26. MD Loading Slot
27. On/Stand-by Switch
28. CD Stop Button: ■
29. CD Play/Pause Button: ▶ ||
30. Volume Up/Down Buttons: ∇ / ▲
31. 3D Surround Mode Select Button
32. 3D Surround On/Off Button
33. Tuner Call (Band Select) Button
34. CD Track Select Button
35. CD Edit Button
36. Name/TOC-Edit Button
37. Timer/Delete Button
38. Display Button
39. Jog Dial
40. Enter Button
41. MD Stop Button: ■
42. MD Play/Pause Button: ▶ ||
43. MD Record Button: ●
44. MD Eject Button: ▲

45. Headphone Socket
46. Reset Button
47. FM Telescopic Rod Aerial
48. AC Power Input Socket
49. Monitor Output Socket
50. Auxiliary Input Socket
51. Auxiliary Input Level Control
52. Microphone Socket
53. AM Loop Aerial Input Socket

REMOTE CONTROL

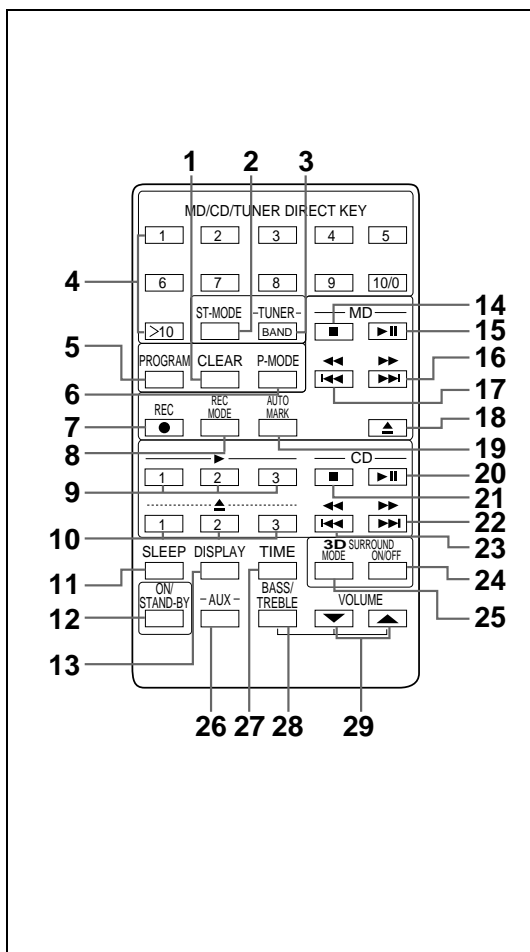

Names of controls

1. Clear Button
2. FM Stereo Mode Button
3. Tuner Call (Band Select) Button
4. Tuner Preset/CD/MD Track Number Input Buttons
5. Programme Button
6. Play Mode Button
7. MD Record Button: ●
8. MD Record Mode Button
9. CD Play Buttons
10. CD Eject Buttons
11. Sleep Button
12. On/Stand-by Button
13. Display Button
14. MD Stop Button: ■
15. MD Play/Pause Button: ► ||
16. MD Track Up/Cue Button: ►► / ►►►
17. MD Track Down/Review Button: ◀◀ / ◀◀◀
18. MD Eject Button
19. Auto Mark Button
20. CD Play/Pause Button: ► ||
21. CD Stop Button: ■
22. CD Track Up/Cue Button: ►► / ►►►
23. CD Track Down/Review Button: ◀◀ / ◀◀◀
24. 3D Surround On/Off Button
25. 3D Surround Mode Select Button
26. Auxiliary Select Button
27. Time Display Select Button
28. Bass/Treble Select Button
29. Volume Up/Down Buttons: ▼ / ▲

Loading the batteries for the remote control

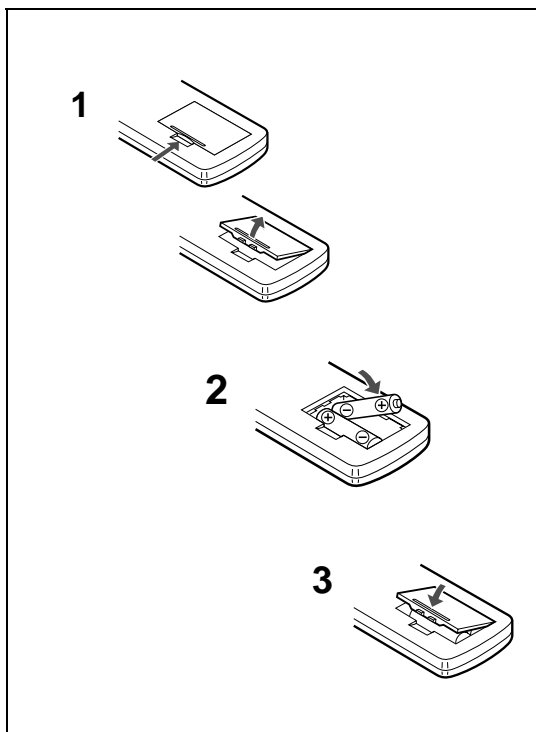

- 1 Remove the battery compartment cover.
- 2 Insert 2 "AA" size batteries (UM/SUM-3, R6, HP-7 or similar) into the battery compartment.
 - When inserting the batteries, push them towards the ⊖ battery terminals.
 - Placing the batteries the wrong way round can cause the unit to malfunction.
- 3 Replace the battery compartment cover.

Battery removal:

- Push the batteries towards the ⊖ battery terminals to remove them.

Precautions for battery use:

- Insert the batteries according to the direction indicated in the battery compartment.
- Replace all old batteries with new ones at the same time.
- Remove the battery if weak or if the unit is not in use for long periods to prevent potential damage due to battery leakage.
- Do not mix old and new batteries.

Caution:

Do not use rechargeable batteries (nickel-cadmium battery, etc.).

(Continued)

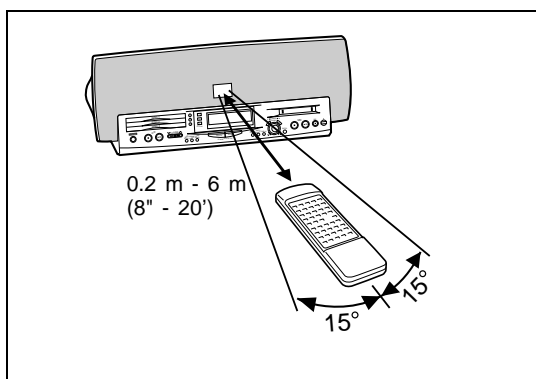

■ Proper use of the remote control

Notes concerning use:

- Replace the batteries if control distance decreases or operation becomes erratic.
- Periodically clean the transmitter window on the remote control and the sensor on the main unit with a soft cloth.
- Exposing the sensor on the main unit to strong light may interfere with operation. Change the lighting or the direction of the unit.
- Keep the remote control away from moisture, excessive heat, shock, and vibrations.

PREPARATION FOR USE

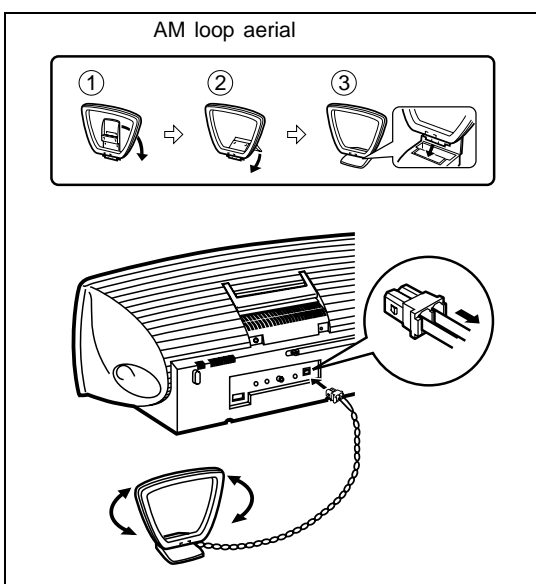

- Unplug the AC power lead from the AC socket before connecting or disconnecting any component.

■ Aerial connection

Connect the AM loop aerial wire to the AM ANTENNA socket. Position the AM loop aerial for optimum reception. Place the AM loop aerial on a shelf, etc., or attach it to a stand or wall with screws (not supplied).

Notes:

- Do not place the aerial on the unit. It may result in noise generation, since the unit is equipped with digital electronics. Place the aerial away from the unit for better reception.
- If the AM loop aerial is placed near the AC power lead, it may cause interference.

Unplugging the connector:

Hold the connector and remove it in the direction indicated by the arrow. Do not pull on the lead.

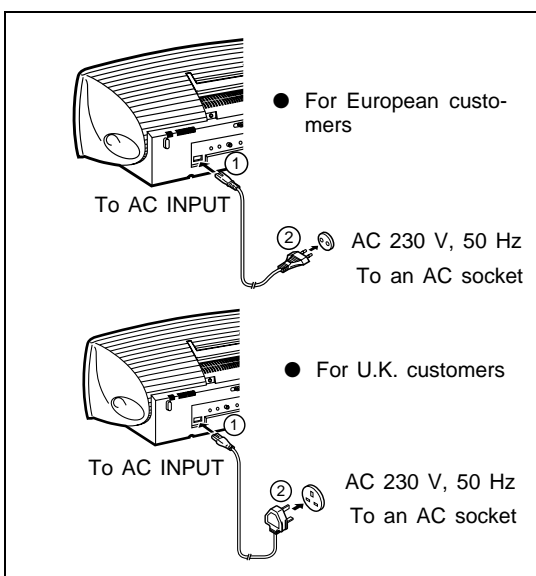

■ Connecting the AC power lead

- After connecting the aerial, connect the AC power lead to the AC power input socket, then connect the AC power lead plug to an AC socket.
- Unplug the AC power lead from the AC socket if the unit is not to be used for a prolonged period of time.
- Never use any power lead other than the one supplied. Otherwise, a malfunction or an accident may occur.
- Before unplugging the AC power lead, set the ON/STAND-BY switch to STAND-BY. If the AC power lead is unplugged whilst the power is on, the information for track numbers may not be written properly during recording or editing.

SETTING THE CLOCK

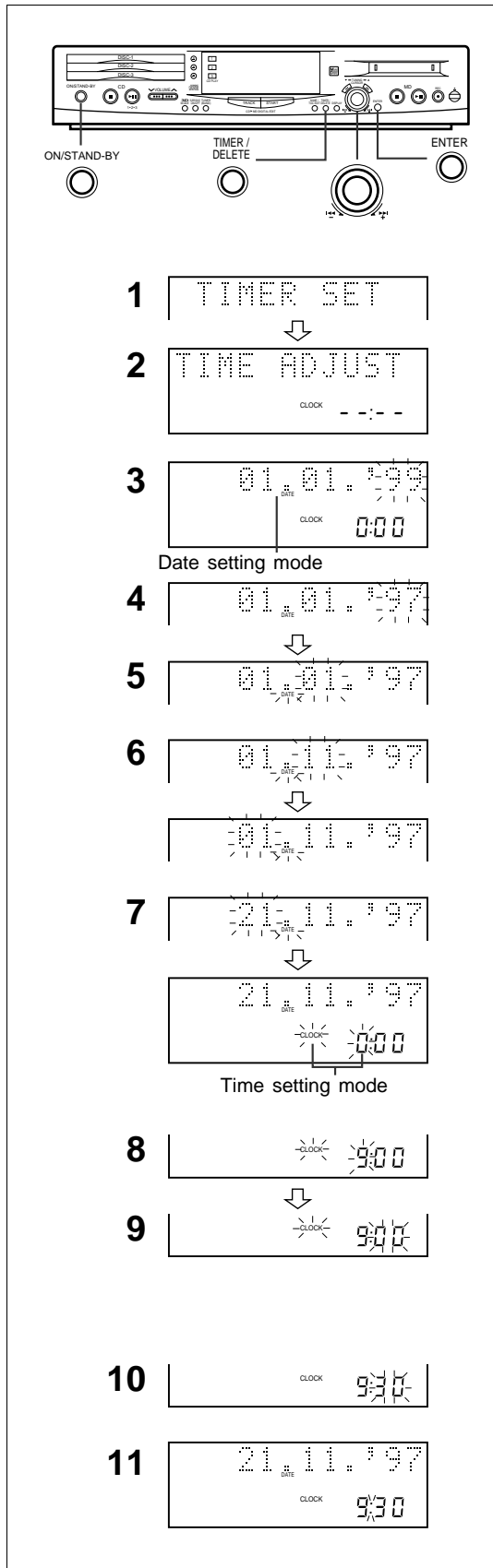

When recording, the date and time are recorded on the MiniDisc (page 18), but only when the date and time have been previously entered, as described in the instructions below.

Setting the date

- 1 Set the ON/STAND-BY switch to ON and press the TIMER/DELETE button.
- 2 Within 10 seconds, turn the jog dial until "TIME ADJUST" appears.
- 3 Within 10 seconds, press the ENTER button.
 - The unit will enter the date setting mode.
- 4 Set the "year" using the jog dial.
 - When you turn the jog dial and let go, the year will change up or down by one. When you turn and hold it, the year will change continuously.
 - The year 2000 or later is set as follows:
[00] indicates the year 2000.
[01] indicates the year 2001.
- 5 Press the ENTER button to set the "year".
- 6 Set the "month" repeating steps 4 and 5.
- 7 Set the "day" repeating steps 4 and 5.
 - The unit will enter the date setting mode.
- 8 Set the "hour" using the jog dial.
 - When you turn the jog dial and let go, the hour will change up or down by one. When you turn and hold it, the hour will change continuously.
 - The clock uses the 24-hour system.
- 9 Press the ENTER button to set the "hour".
- 10 Adjust the "minute" using the jog dial.
- 11 Press the ENTER button to set the "minute".
 - When the ENTER button is pressed, the clock will show the correct time.

Note:

- If a power failure continues for more than 10 minutes or the AC power lead is disconnected for more than 10 minutes, the date and time settings will be lost. If they are lost, set them again.

Checking the date and time:

After pressing the TIMER/DELETE button, turn the jog dial until the date and time are displayed.

Resetting the date and time:

See "Setting the clock".

- Once you have set the date and time, "TIME ADJUST" will not be displayed in step 2. Turn the jog dial to make the date and time appear.
- If you don't need to change the settings, just press the ENTER button without turning the jog dial again.

SOUND CONTROL

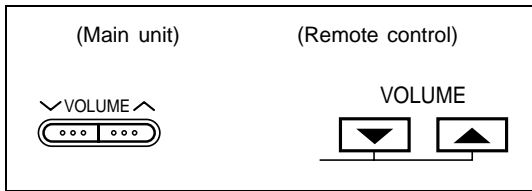

■ Volume

Press the VOLUME ▲ button to increase the volume and the VOLUME ▼ button to decrease the volume.

- The volume display can be changed within the range of "0" to "10".

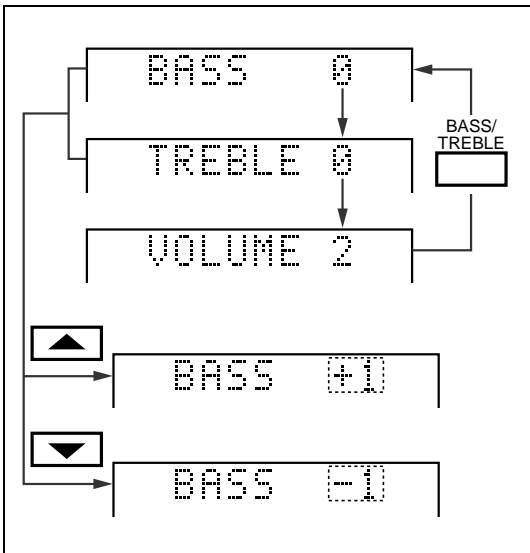

■ Treble

Remote control operation

Press the BASS/TREBLE button until the TREBLE display appears. Press the VOLUME ▲ button to increase the high-frequency level, and press the VOLUME ▼ button to decrease the level.

■ Bass

Remote control operation

Press the BASS/TREBLE button until the BASS display appears. Press the VOLUME ▲ button to increase the low-frequency level, and press the VOLUME ▼ button to decrease the level.

(Continued)

3D SURROUND MODE ON/OFF

MD/CD/TUNER DIRECT KEY
 1 2 3 4 5
 6 7 8 9 1000
 ST-MODE TUNER BAND MD
 >10 PROGRAM CLEAR P-MODE
 REC REC AUTO
 MARK MARK
 1 2 3 CD
 1 2 3 3D SURROUND
 SLEEP DISPLAY TIME MODE ON/OFF
 ON STANDBY -AUX- BASS TREBLE VOLUME

3D SURROUND MODE ON/OFF

Ordinary stereo sound

Listening area
(Listening range with good stereo fidelity)

SRS (●) 3D SURROUND

Wide listening area
(Stereo music can be heard anywhere in the room.)

SRS (●) 3D SURROUND

About SRS (●) 3D surround:

SRS is a breakthrough technology that creates 3-dimensional sound by processing sound signals based on the human auditory system. It produces real depth and localization of the sound image which cannot be accomplished by ordinary stereo. SRS only requires two speakers.

SRS (●) 3D surround effects:

- Live performance atmosphere
(Simulates a live concert atmosphere)
- The localization of various musical sources is quite clear.
(The positions of the musical instruments and singers are very clear.)
- Reproduction of depth
(Sounds from the front and back of an orchestra can be identified easily.)
- Expansion of the sound field
(The sound image is spread out over a wide area.)

When listening to a stereo sound source:

When the sound source is in stereo, you can select from any of 5 different 3D surround effect.

- 1 Select any desired audio source and begin playback.
- 2 Press the 3D SURROUND ON/OFF button to enter the 3D surround mode.
- "3D SURROUND" will appear.
- 3 Press the MODE button repeatedly to select the desired mode.
- When the MODE button is pressed in the 3D surround mode, the current mode will be displayed. When you press the MODE button again, you can switch the mode. About 3 seconds later, the display will return to the original mode.

MODE 1 → MODE 2 → MODE 3 → MODE 4 → MODE 5 → 3D MONO

SURROUND MODE	Effect from each mode
MODE-1	You will enjoy a sound image that produces an intimate sound field. (as in a medium-size hall)
MODE-2	This setting gives you a maximum sound field as music comes out beyond the speakers. (as in a large, domed arena)
MODE-3	This setting is great for live recording and vocal music.
MODE-4	You will hear more vocals in an intimate sound field. (as at a live music performance)
MODE-5	This setting greatly increases the amount of vocals or center sounds in a recording. (as in a small club)
3D MONO	This setting produces a 3D surround sound from a monaural sound source, for example a video game with monaural output.

To cancel the 3D surround effect:

- Press the 3D SURROUND ON/OFF button.
- "SURROUND OFF" will be displayed, and the 3D surround effect will be cancelled.

COMPACT DISC OPERATION

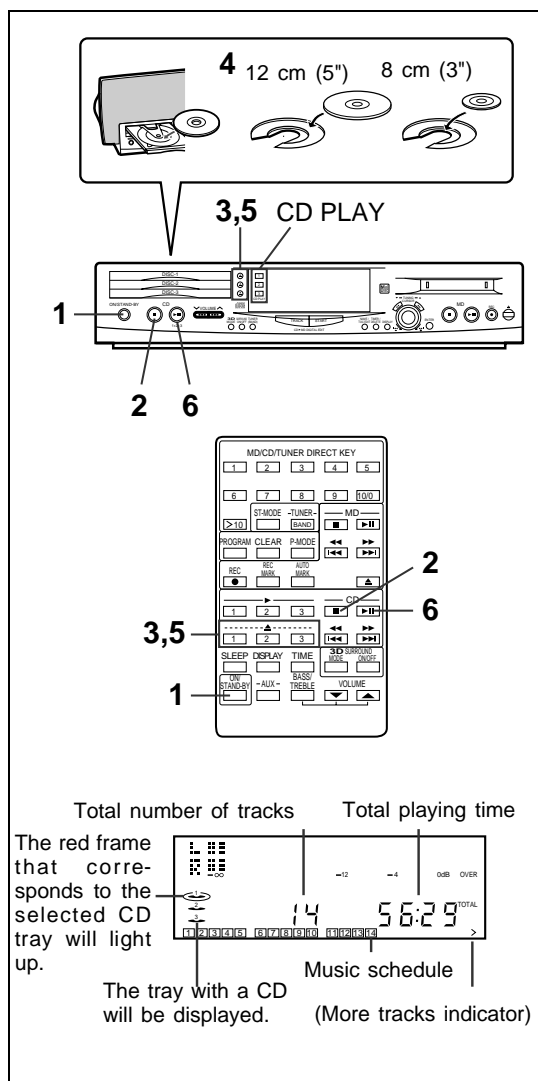

■ Loading and playing CDs

- 1** Set the ON/STAND-BY switch to ON.
 - 2** Press the CD ■ button.
 - 3** Press the ▲ button to open the disc tray.
 - Press the button of the disc tray (1 - 3) where you want to load a disc.
 - You cannot open more than one disc tray at the same time.
 - 4** Place the CD(s) on the disc tray, label side up.
 - Be sure to place 8 cm (3") disc in the middle of a disc holder.
- Caution:**
Do not place more than 1 CD in any tray position.
This can damage the player and the CDs.
- 5** Press the ▲ button of the disc tray which is open.
 - Repeat steps 3 - 5 to load one disc each into the second and third disc trays.
 - The total number of tracks and the total playing time on the selected disc will be displayed. At this time, the red frame that corresponds to the selected disc tray will light up.
 - The music schedule will be displayed only for the number of tracks on the disc.
 - If the CD contains more than 21 tracks, ">" will appear.
 - 6** Press the CD ► || button.
 - Playback will begin from track 1 on the disc you have specified to play.
 - After the disc finishes playing, the next disc will be automatically played.
 - When there is no CD in one of the disc 1 - 3 positions, that position will be skipped and the next CD will be played.
 - When the CD ► || button is pressed after a track is chosen with the jog dial whilst the red frame mark of Disc 1 is lit, playback will start from the chosen track.
 - When the CD PLAY "2" button is pressed after the CD ► || button has been pressed, continuous playback will be performed, in order, from disc 2 and disc 3. When the CD PLAY "3" button is pressed, only disc 3 will be played back.
 - When the last track on the third disc has finished playing, the unit will stop automatically.

To interrupt playback:

Press the CD ► || button.

Press the CD ► || button to resume playback from the same point.

To stop playback:

Press the CD ■ button.

To remove the CDs:

Whilst in the stop mode, press the ▲ button.

- When playing back a CD, it is possible to remove or change the other two as required.

To switch the unit off after use:

Set the ON/STAND-BY switch to STAND-BY.

(Continued)

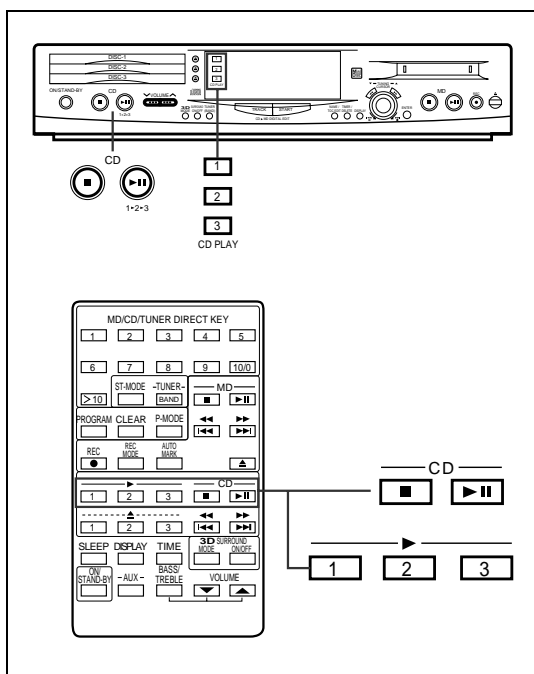

When choosing a CD for playback

Press one of the buttons CD PLAY 1 - CD PLAY 3 to select the CD you want to listen to.

- Only the selected CD will be played back.

When selecting disc tray 1

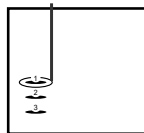

When selecting disc tray 2

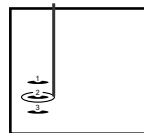

When selecting disc tray 3

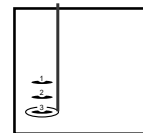

Notes:

- If any disc tray is open, it will be automatically closed.
- If the CD ►|| button is pressed, continuous playback will be performed from the first track of disc 1, even after disc 2 or disc 3 has been selected.

Direct playback:

If a CD is loaded in the unit, pressing the CD ►|| button turns the power on and begins playback.

Cautions:

- Do not carry the unit whilst CD's are in the trays or a MiniDisc is loaded. The discs may come loose inside the unit and be damaged or cause damage to the unit. This may also cause malfunctions.
- Do not place two CDs in one disc position.
- Do not push the disc tray whilst it is moving.
- Do not attempt to push the disc tray by hand. This may cause malfunctions.
- If power fails whilst the tray is open, wait until the power supply returns or gently push the tray manually to close it.
- If the disc tray is stopped forcibly, "TRAY ERROR" will appear on the display and the unit will not function. If this occurs, turn off the ON/STAND-BY switch and turn it on again.
- If TV or radio interference occurs during CD operation, move the unit away from the TV or radio.
- If a disc is damaged, dirty, or loaded upside down, the disc will be skipped and the next disc will be automatically played.
- If the CDs are dirty or have label adhesive on their surface, make sure to clean them before loading. If a rental CD is loaded or a label has been peeled off from the CD, the surface may be dirty or sticky. Wipe any dirt from the surface. If a dirty CD is loaded and played back, it may become damaged, or it could become stuck in the unit.
- If the CD ►|| button, CD PLAY 1 - 3 button or the ▲ button is pressed when a disc tray is open, the disc tray will be automatically closed. Be careful not to catch your finger.
- If the machine is shaken by impact or vibration, playback may be disrupted. If the playback volume of a CD is raised excessively, playback may be disrupted. If this happens, lower the playback volume.

MINIDISC OPERATION

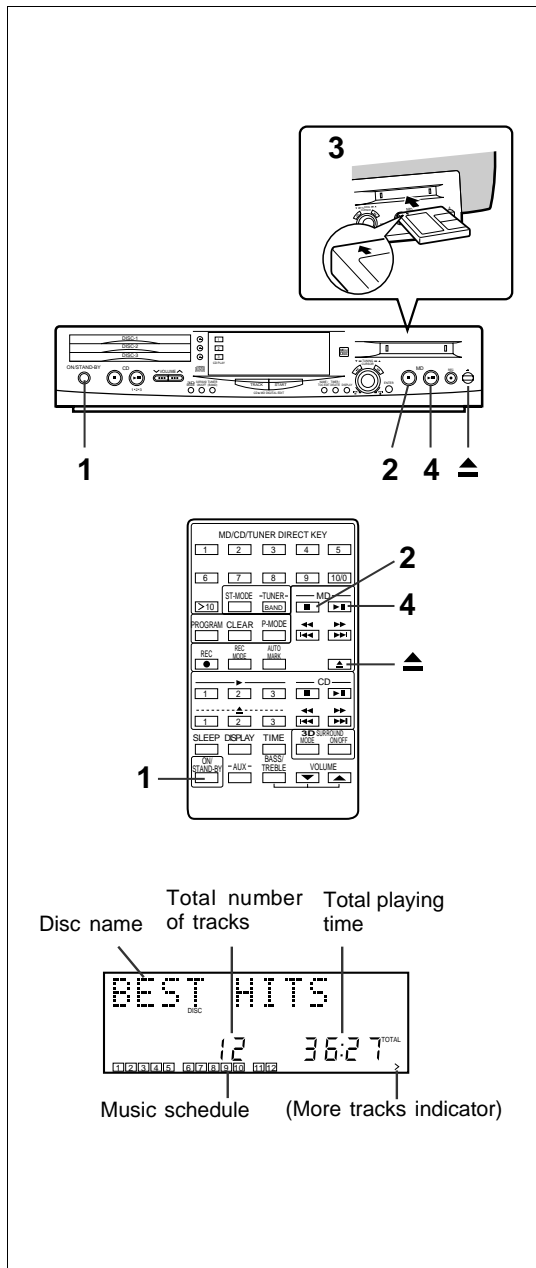

■ Loading and playing MiniDiscs

- 1 Set the ON/STAND-BY switch to ON.
- 2 Press the MD ■ button.
- 3 Load a MiniDisc in the direction indicated by the arrow on the MiniDisc, with the labeled side facing up.
 - The total number of tracks and the total disc playing time will be displayed.
 - The music schedule will be displayed only for the number of tracks on the disc.
 - If the MD contains more than 21 tracks, ">" will appear.
- 4 Press the MD ► || button.
 - If the MD has a name, the name will be scrolled.
 - If the disc name or track name has not been programmed, "NO NAME" will appear.
 - When the last track has been played back, this unit will stop automatically.

To interrupt playback:

Press the MD ► || button.

- Press the MD ► || button to resume playback from the same point.

To stop playback:

Press the MD ■ button.

To remove a MiniDisc:

Press the ▲ button.

- The MiniDisc will be ejected.

Direct playback:

If a MiniDisc is loaded in the unit, pressing the MD ► || button turns the power on, and begins playback.

Notes:

- The power cannot be turned off during reading of the information on a MiniDisc.
- If TV or radio interference occurs during MD operation, move the unit away from the TV or radio.
- Although MiniDiscs will not normally skip due to vibration, you may hear a skip in the sound if there is continuous vibration. When the volume is turned up too high, a skip may occur depending on the contents of MDs. If this happens, turn the volume down and the skipping should stop.
- If "DISC ERROR" is displayed during MD operation, see "TROUBLESHOOTING" on page 40, and try again.

RADIO OPERATION

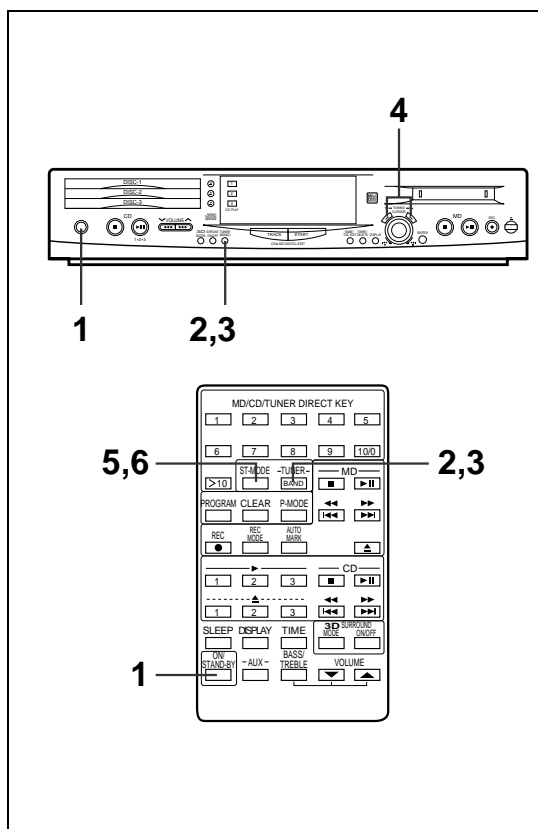

Tuning

- 1 Set the ON/STAND-BY switch to ON.
- 2 Press the TUNER (BAND) button.
- 3 Press the TUNER (BAND) button to select the desired frequency band. (FM or AM)
- 4 Press the TUNING (▼ or ▲) button to tune into the desired station.

Manual tuning:

Press the TUNING (▼ or ▲) button as many times as required to adjust the frequency shown on the display to the frequency of the desired station.

Auto tuning:

When the TUNING (▼ or ▲) button is pressed for more than 0.5 seconds, scanning will start automatically and the tuner will stop at the first receivable broadcast station.

Notes:

- When radio interference occurs during auto scan tuning, auto scan tuning may stop automatically at that point.
 - If a weak station signal is found during auto scan tuning, the station will be skipped.
 - To stop the auto tuning, press the TUNING (▼ or ▲) button again.
- 5 To receive an FM stereo transmission, press the ST-MODE button on the remote control so that the "STEREO" indicator on the display lights up.
 - "ST" will appear when an FM broadcast is in stereo.
 - 6 If the FM reception is weak, press the ST-MODE button on the remote control so that the "STEREO" indicator goes out.
 - Although the reception changes to monaural, the sound becomes clearer.

Aerial adjustment



To switch the unit off after use:

Set the ON/STAND-BY switch to STAND-BY.

Notes:

- The tuners memory will store the last station you were listening to in each band, even when the ON/STAND-BY button is switched to STAND-BY.
- If the unit receives a radio broadcast near a radio or a TV set, the radio, the TV set or the unit may pick up noise. Move the unit as far away from the TV set or radio as possible.

Direct playback:

When the TUNER (BAND) button is pressed and the power is turned on and the last received station will be selected.

(Continued)

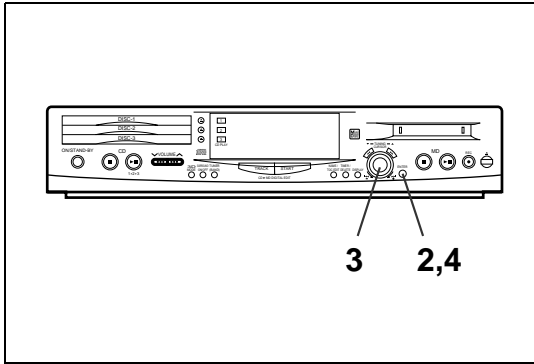

■ Preset tuning

You can store up to 40 stations in memory (40 stations consisting of any combination of FM and AM stations you like) and recall them at the push of a button.

To enter stations into memory:

- 1** Perform steps 1 - 6 in the "Tuning" section.
- 2** Press the ENTER button.
- 3** Within 5 seconds, turn the jog dial until the preset channel number flashes in the display.
 - Store the stations in memory, in order, starting with preset channel 1.
- 4** Within 5 seconds, press the ENTER button to store that station in the selected station preset number memory.
 - If the preset number indicators go out before the station is memorised, repeat the operation from step 2.
- 5** Repeat steps 1 - 4 to set other preset stations, or to change a preset station.
- When a new station is stored in the selected station preset number memory, the contents previously memorised will be erased.

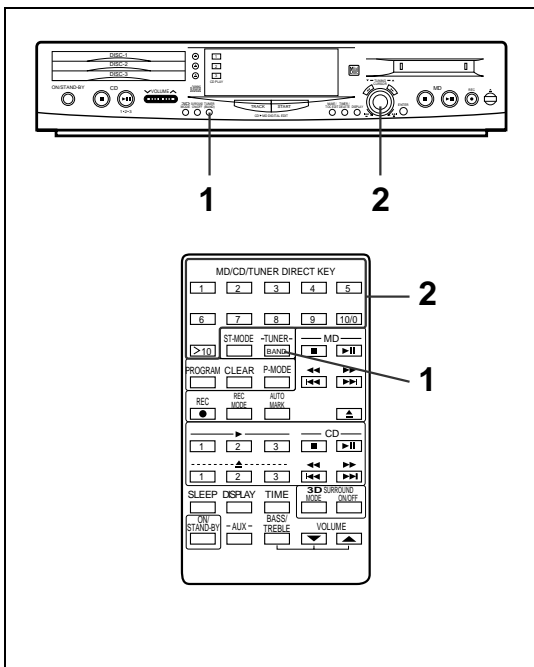

To recall a memorised station:

- 1** Press the TUNER (BAND) button.
- 2** Press the tuner preset number button on the remote control or turn the jog dial on the main unit to recall the preset channel number.
 - The frequency will appear on the display.

For example, to select 5:

Press the "5" button.

For example, to select 23:

- ①** Press the > 10 button.
- ②** Within 5 seconds, press the "2" button.
- ③** Within 5 seconds, press the "3" button.

Backup function:

The backup function protects all station presets for at least two days should there be a power failure or the AC power lead is unplugged from the AC socket.

CONVENIENT CD AND MD OPERATIONS

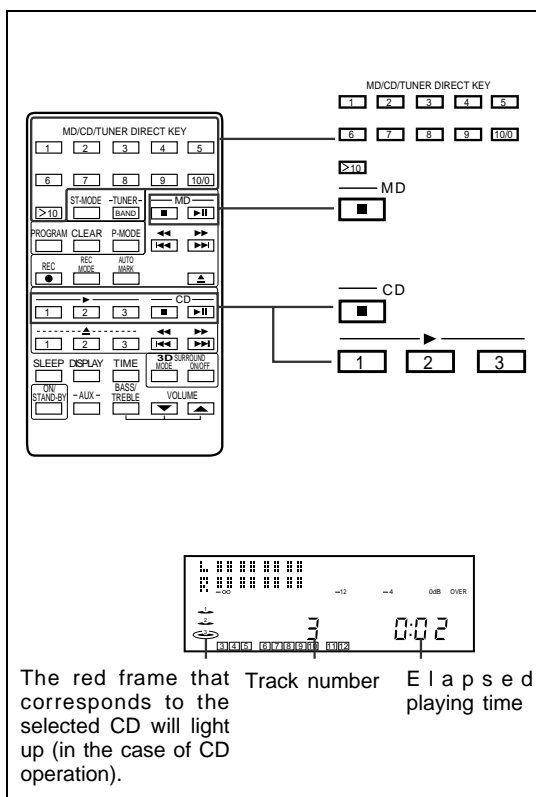

Direct-selection play

By using the track number input buttons on the remote control, any track you wish can be played directly.

- 1 Select the desired programme source, CD or MD, by pressing the CD ■ or MD ■ button.
- 2 When CD is selected, press one of the buttons ► 1 - ► 3 to select the CD you want to listen to.
- 3 Press the CD ■ button.
- 4 Use the track number input buttons to select the desired track number.

A. To select track number 11 to 99

Press the > 10 button first, then press the track number.

For example, to select 36:

- ① Press the > 10 button.
- ② Within 5 seconds, press the "3" button.
- ③ Within 5 seconds, press the "6" button.

B. To select track number 100 or higher (only for MD)

Press the > 10 button twice, then press the track number.

For example, to select 128:

- ① Press the > 10 button.
- ② Within 5 seconds, press the > 10 button.
- ③ Within 5 seconds, press the "1" button.
- ④ Within 5 seconds, press the "2" button.
- ⑤ Within 5 seconds, press the "8" button.

The beginning of the selected track will be found, and play will begin automatically.

Notes:

- A track number higher than the number of tracks on the disc cannot be selected.
- During APMS play or random play, track number selection play is not possible.

APSS (Auto Program Search System)

APSS automatically locates the beginning of any track.

To move to the beginning of the next track:

During playback ... Turn the jog dial clockwise. Or press the ►► button on the remote control.

To restart the track being played:

During playback ... Turn the jog dial anti-clockwise. Or press the ◀◀ button on the remote control.

When using the jog dial whilst in the stop mode:

Every time the jog dial is turned (or each time the ◀◀ or ►► button on the remote control is pressed), the track number will go up or down by one. If you press the ►|| button, playback will begin from the track being displayed.

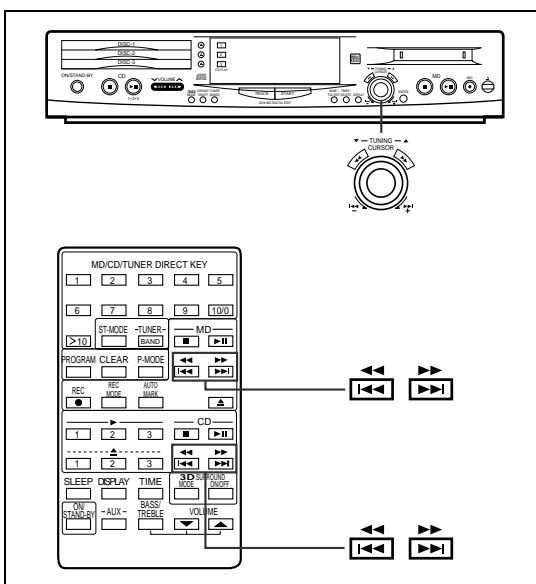

(Continued)

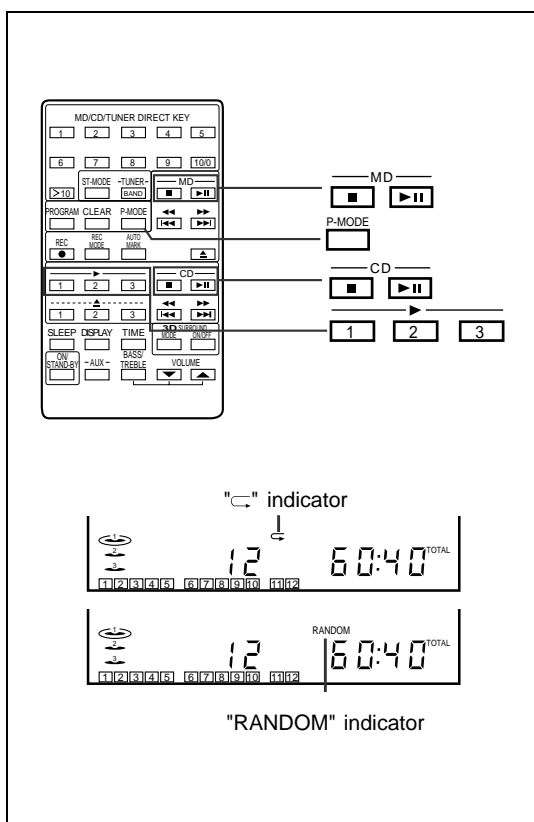
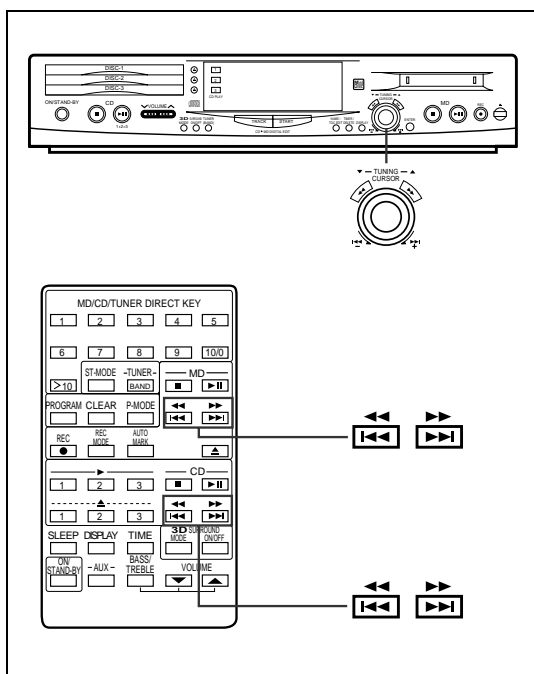

■ Cue and review

- 1 Load a disc and begin playback.
- 2 Hold the ►► button down for audible fast forward, and hold the ◀◀ button down for audible fast reverse.
- 3 Normal playback will resume when the ►► or ◀◀ button is released.

Notes:

- When the beginning of the first track is reached, normal playback will start.
- When the end of the last track is reached, "DISC END" will light, and the unit will pause. If you want to listen to a portion of a track again, press the ◀◀ button to return to the point in the track you want to listen to. Normal playback will start from that point.

To search very quickly:

When fast forward or fast reverse is used whilst in the pause mode, the playback point will move more quickly than when using audible fast forward or audible fast reverse playback.

- In this mode, no sound is heard. Therefore, you should refer to the time display.
- When you lift your finger, the unit will re-enter the pause mode.

■ Repeat and random play

- 1 Select the desired programme source, CD or MD, by pressing the CD ■ or MD ■ button.
- 2 Press the P-MODE button.
 - Each time this button is pressed, the mode will change in the following order:
Repeat play → Random play → Normal play → Repeat play
- 3 Press the ►|| button to start playback.
 - To specify a disc from disc trays 1 - 3, press one of the buttons ► 1 - ► 3.

- Repeat play
After the last track has been played back, playback will return to the first track and begin again.

- Random play
When the ►|| button is pressed, all of the tracks on a CD will be played back in random order until playback is stopped. When the buttons ► 1 - ► 3 are pressed, all of the tracks will be played back at random, and then playback will stop. (The same track will not be played back twice.)

To cancel repeat or random play:

Press the P-MODE button until the ◻ or "RANDOM" display disappears.

To repeat playback of selected tracks:

Enter the programme for the tracks you want and start repeat play. You can programme a single track and play it repeatedly.

Notes:

- During APMS play, random play is not possible.
- When repeat or random play is selected during CD or MD playback, repeat or random play will start at that point.

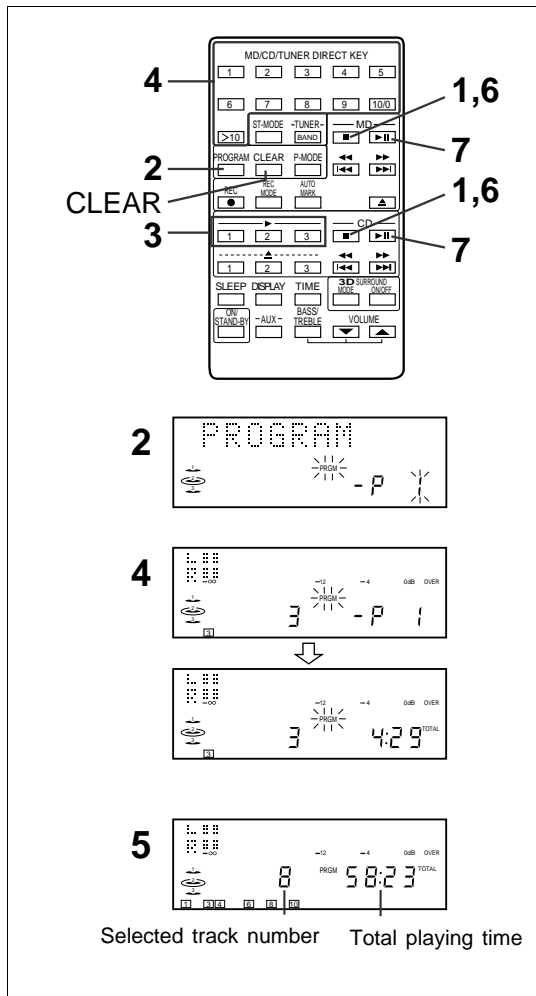
(Continued)**How to perform APMS operation from the main unit:**

- 1** Press the CD ■ button.
- 2** Press the TRACK button and hold it for at least 2 seconds.
 - "PRGM" will flash.
- 3** If you have selected CD, press one of the buttons (▶ 1 - ▶ 3) to select the disc to be played.
- 4** Select the desired track by turning the jog dial, and then press the TRACK button.
- 5** Repeat steps 3 - 4 for any other track. Up to 32 tracks can be programmed.
- 6** Press the CD ■ button.
- 7** Press the CD ▶ || button to start playback of programmed selections.

To cancel the APMS:

Whilst the unit is stopped in the APMS mode, press the TRACK button and hold it for at least 2 seconds.

APMS**(Automatic Programmable Music Selector)****Remote control operation**

- 1** Select the desired programme source, CD or MD, by pressing the CD ■ or MD ■ button.
- 2** Press the PROGRAM button.
 - "PRGM" will flash.
- 3** If you have selected CD, press one of the buttons (▶ 1 - ▶ 3) to select the disc to be played.
- 4** Use the track number input buttons to designate the desired track number.
- 5** Repeat steps 3 and 4 for any other tracks. Up to 20 tracks for MD or 32 tracks for CD can be programmed.
 - To select the track on an MD or on the same CD, skip step 3.
 - The programmed playback order and the total playing time of the programmed tracks will be automatically displayed, and only those track numbers will appear in the music schedule.
 - If the total playing time of the programmed tracks exceeds 199 minutes 59 seconds, "--:--" will be displayed. In such a case, the programmed tracks are stored.
- 6** Press the CD ■ or MD ■ button.
 - "PRGM" will appear.
- 7** Press the CD ▶ || or MD ▶ || button to start playback of the programmed selections.
 - After all of the programmed tracks have finished playback, the unit will automatically stop.

To clear the programmed selections:

Press the CLEAR button whilst the "PRGM" indicator is flashing.

- Each time the button is pressed, one track will be cleared, beginning with the last track programmed.

To cancel the APMS:

Whilst the unit is stopped in the APMS mode, press the CLEAR button to turn off the "PRGM" display.

- The programme contents will be erased.
- When you open the disc tray or a MiniDisc is removed, the APMS mode will be cancelled.

To check which tracks are programmed:

Whilst the unit is stopped in the APMS mode, turn the jog dial. Or press the ◀◀ or ▶▶ button on the remote control.

- When the jog dial is turned clockwise, the next track number will appear. When it is turned anti-clockwise, the previous track number will appear.

To add tracks to the APMS:

If a programme has been stored previously, the "PRGM" indicator will be displayed. Then follow steps 2 - 6. Additional tracks can be selected, and they will be stored after the last track you entered.

Notes:

- It is not possible to insert an additional track between programmed tracks that have already been entered.
- Programming and cancelling are not possible during playback or in the pause mode.

(Continued)

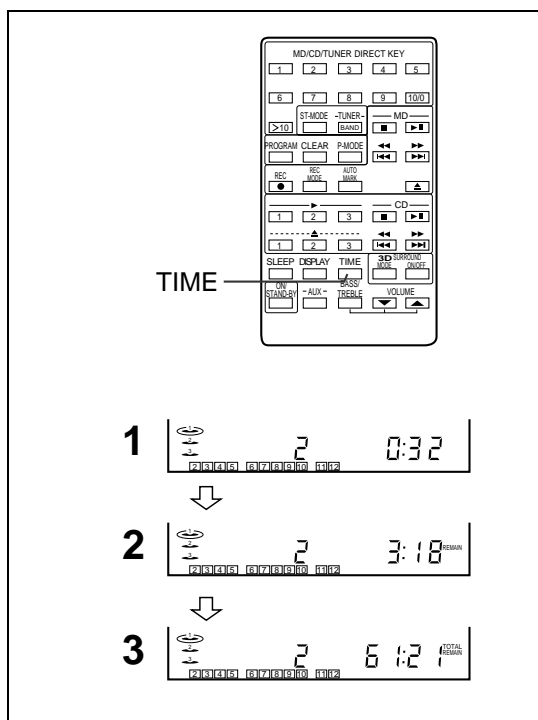

Switching the time display

Each time the TIME button is pressed during playback or pause, the display will change as described below.

See the diagram to the left

- 1 The elapsed playing time for each track will be displayed.
- 2 The remaining playing time for the current track will be displayed.
- 3 The total remaining playing time for the disc from the point being played at that time will be displayed.

Notes:

- During random play, only the elapsed playing time for each track will be displayed. The display cannot be switched.
- Depending on a CD or MD to be played, the playing time display may not match the playing time which is indicated on the CD or MD jacket, because the time between the tracks is not included.

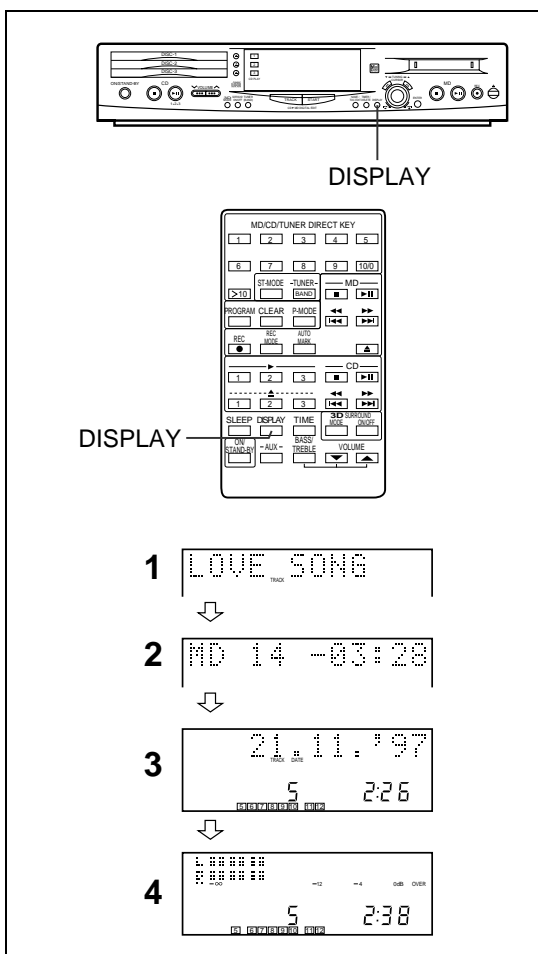

Changing the display during MD playback

Each time the DISPLAY button is pressed during playback or pause, the display will change as described below.

See the diagram to the left

- 1 The track name will be displayed.
 - If a track name has not been programmed, "NO NAME" will appear.
- 2 The remaining recording time will be displayed.
- 3 The date and time recorded will be displayed.
- 4 The level meter will be displayed.

Changing the brightness of the display section:

If you need to operate the unit in different lighting conditions, you can change the brightness of the display section. When the power is on, press the DISPLAY button for at least two seconds.

- The display section will become brighter. To return to the original brightness, press the DISPLAY button again for at least two seconds.

Note:

- The brightness of the display section is remembered even after the power has been turned off.

RECORDING

■ Differences from tape recordings

You cannot record music on the reverse side of a MiniDisc.

MiniDiscs are single sided and should only be inserted with the correct side up. (Page 39)

You don't need to search for the starting point at which to record.

The unit automatically finds the point at which recording can start. Recording will start from that point.

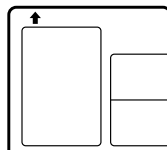

You can check the total or remaining recordable time (possible recording) before recording.

This lets you plan a recording session so that the last song will not come to an abrupt end before it has finished. (Page 17)

The date and time of a recording are automatically saved with the recording.

If you have set the date and time, they will be automatically recorded when a recording is made. (Page 6)

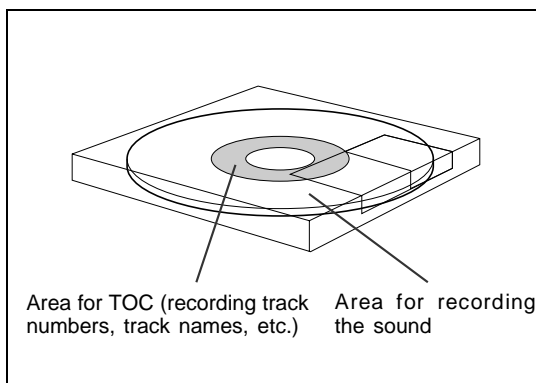

■ Disc writing (TOC)

The TOC (Table of Contents) is information on track numbers and recording areas to allow the unit to recognize musical selections or sounds.

The entire MD is controlled depending on this TOC, which enables the unit to find the beginning of a track quickly or to automatically record in a vacant area.

When you start recording or editing, "TOC" will appear in the display window.

This indicates that information in the TOC is now being changed according to recording or editing being performed. (The changed TOC is not yet recorded on the MiniDisc at this time.)

The TOC is recorded when

- you stop recording.
- you switch to another input source.
- you eject the MiniDisc.
- you turn the power off.

Do NOT unplug the power lead whilst the TOC is being recorded ("TOC" is flashing) and do NOT impart shock to the unit. Otherwise, TOC will not be correctly recorded, and consequently proper playback may not be possible.

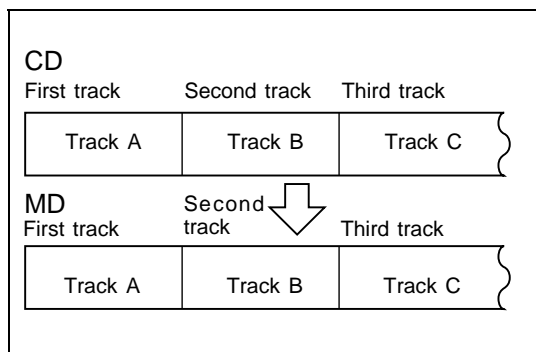

■ About track numbers

When recording from CD

New track numbers will be created automatically according to the original tracks (Synchro maker function).

- When you record from a CD to a MiniDisc, the track numbers recorded on the MiniDisc may not match the track numbers on the CD. If this happens, correct the track numbers using the DIVIDE (page 24) and COMBINE (page 25) functions after recording.

(Continued)

Recordings cannot be made in the following situations.

- If you try recording on a playback-only MiniDisc (commercially available music)
- If a MiniDisc is protected against accidental erasure (Page 38)
- If there is no more recording time left on the disc (Page 17)
- When the "TOC FULL" message appears (Page 39)
- If a disc's TOC has been damaged
- If you are trying to copy a digital signal that has been encoded with the SCMS signal (Serial Copy Management System)

Notes:

- When recording important selections, be sure to make a preliminary test to ensure that the desired material is being properly recorded.
- The VOLUME, X-BASS, TREBLE and 3D SURROUND controls may be adjusted with no effect on the recorded signal. (Variable Sound Monitor)



(Continued)

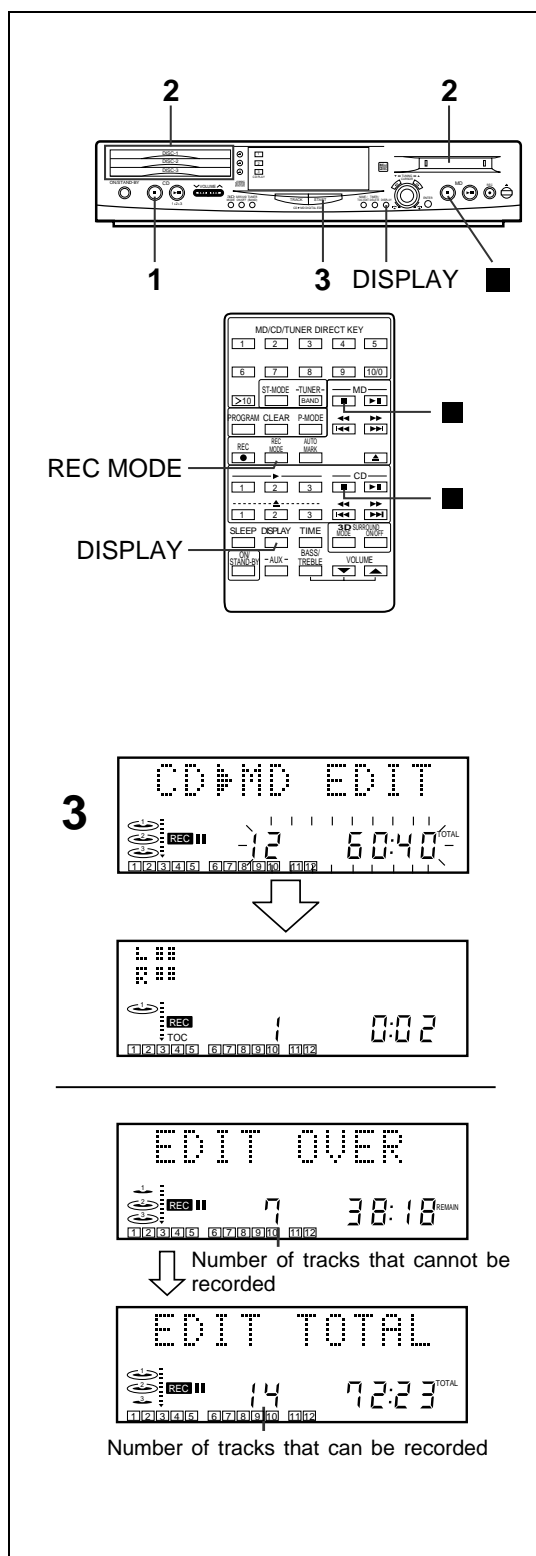

Recording from a CD onto a MiniDisc (One-Touch Editing)

- 1** Press the CD ■ button.
- 2** Load a compact disc and a recordable MiniDisc.
 - The total number of tracks and the total playing time on the CD will be displayed.
 - When a new recordable MiniDisc is loaded, it will take about 15 seconds to enter the record standby mode.
- 3** Press the START button.
 - Playback of the first track and recording will begin.
 - When all discs are recorded, recording will automatically stop.

If recording does not begin

When a disc is loaded in each of disc tray 1 - disc tray 3, if all of the tracks on the discs cannot be recorded, the number of tracks that cannot be recorded will be displayed, and then the number of tracks that can be recorded will appear. Then, the unit will enter the record standby mode.

Press the START button.

- Recording will begin, starting from the first track on disc tray 1.
- After recording all of the tracks that can be recorded, the unit will automatically stop.

To stop recording:

Press the CD ■ or MD ■ button.

- Playback and recording will stop after the track numbers have been written on the MiniDisc.
- It is not possible to pause recording.

To check the remaining time available for recording:

- 1** Load a MiniDisc.
- 2** Press the DISPLAY button.
 - The number of tracks that have been already recorded and the available time remaining will be displayed, and five seconds later the unit will return to the original display.

To record for a long time in the monaural mode (monaural long-play mode)

When a recording is made in the monaural long-play mode, it can be about twice as long as the recording time available for a stereo recording. The monaural long-play mode is very useful for recording songs that were originally recorded in monaural, or for recording talk programmes.

Press the REC MODE button on the remote control.

- Each time the button is pressed, the display will switch between the stereo mode and the monaural long-play mode.
- This mode cannot be changed whilst recording.

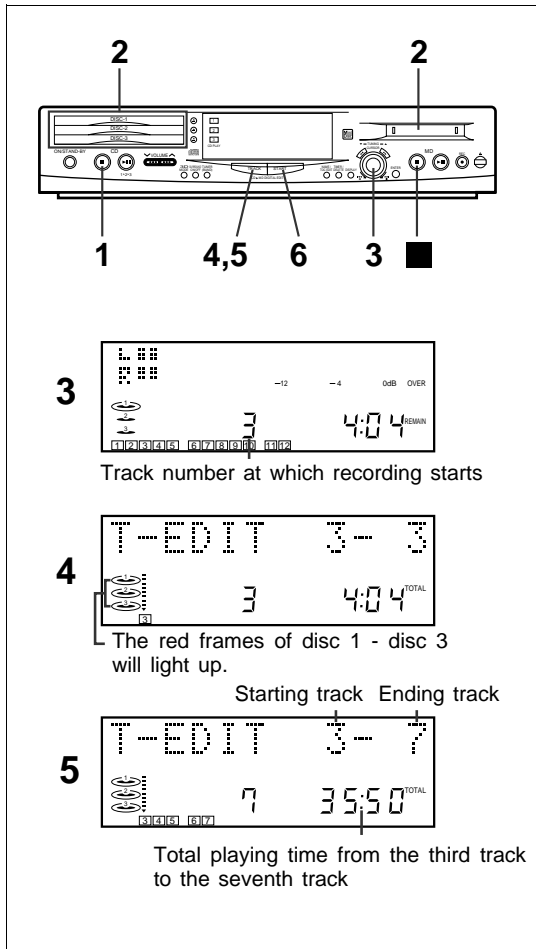
(Continued)**Recording desired tracks from a compact disc onto a MiniDisc (Track Editing)**

- 1** Press the CD ■ button.
- 2** Load a compact disc and a recordable MiniDisc.
- 3** Select the track to start recording by turning the jog dial
 - The selected track number appears.
- 4** Press the TRACK button.
 - To record a single track, skip to step 6.
- 5** Select the last track to record by pressing the TRACK button.
- 6** Press the START button.
 - Recording will start from the tracks selected in disc 1, disc 2 and disc 3, in that order. After recording, the CD and the MD will stop automatically.

To cancel the track edit operation:

Press the CD ■ button before pressing the START button.

To stop recording:

Press the MD ■ button.

- After the track numbers have been written on the MiniDisc, playback and recording will stop. It is not possible to pause recording.

APMS recording

- 1** Select tracks for APMS playback. (Page 16)
- 2** Load a recordable MiniDisc.
- 3** Press the START button.
 - APMS playback will start, and recording will start automatically.
 - Programmed tracks will be recorded in order. After the unit has finished recording the last track, recording will stop automatically.

To stop recording:

Press the MD ■ button.

(Continued)

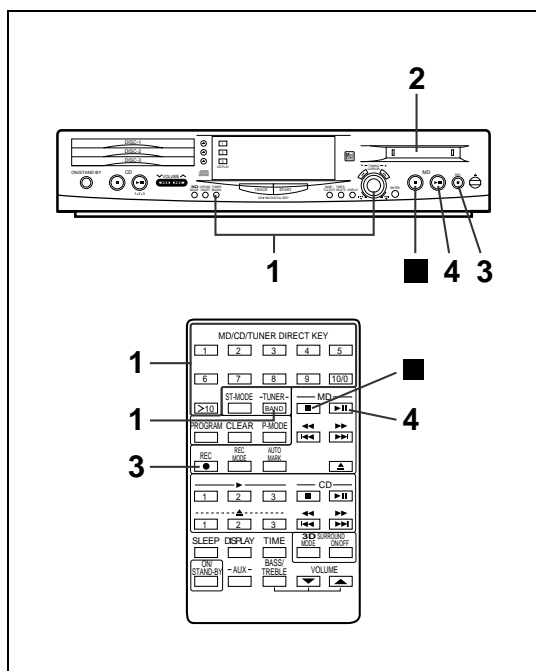

Recording from the built-in radio onto a Mini-Disc

- 1** Tune in to the desired station. (See pages 12 - 13.)
- 2** Load a recordable MiniDisc.
- 3** Press the REC ● button.
 - The unit will enter the record stand-by mode. At this time, auto tuning is impossible.

Note:

- Before recording an AM broadcast, enter the record standby mode, and then separate the AM loop aerial from the main unit. Adjust it so that the AM broadcast can be tuned in most clearly.

- 4** Press the MD ► || button.
 - During recording, you cannot change the station.

To stop recording:

Press the MD ■ button. After the track number has been written on the MiniDisc, the recording will stop.

To interrupt recording:

Press the MD ► || button during recording. Press the MD ► || button again to resume recording. The track number increases.

To record the track number during recording:

A recording is performed as a single track. To identify different sections of the recording you can increase the track number at any point during the recording process. To create a new track number, whilst in the record mode, press the REC ● button.

- The track number will increase by one, and then the recording will continue.
- If you press the REC ● button and assign a track number, a space of at least 15 seconds should be given between tracks. If the space is shorter than 15 seconds, tracks may not be connected when they are edited.

To record without using One-Touch Editing

Without using one-touch recording, the following operation allows you to record from the first track.

- 1** Press the CD ■ button.
- 2** Load a compact disc and a recordable MiniDisc.
- 3** Press the REC ● button.
 - The unit will enter the record stand-by mode.
- 4** Press the CD ► || button.

To stop recording:

Press the MD ■ button.

- After the track number has been written on the Mini-Disc, the recording will stop. However, CD playback will continue.

To re-record

When you want to re-record, you can erase a track that is already recorded, starting from any point in the old track, to begin a new recording. Be aware that when you do this, all of the tracks and track names that follow the newly recorded track will be erased.

- 1** During playback, press the MD ► || button at the point where you want to begin re-recording.
 - The unit will pause.
- 2** Press the REC ● button.
 - "R. ERASE OK?" will be displayed.
- 3** Press the ENTER button.
 - This unit will be in the recording pause mode.
 - To cancel the operation, press the MD ■ button.
- 4** Select the recording source and start recording.

EDITING

We will explain the 5 editing functions with which you can create your own original discs from recorded MiniDiscs. Play-back-only MiniDiscs cannot be edited.

DIVIDE

A track can be divided into two tracks. If two selections were recorded as a single track because there was not enough silent space between the pieces, you can use the DIVIDE function to separate the selections. This feature is also convenient for identifying specific points with one selection so that you can locate those points easily whenever you like.

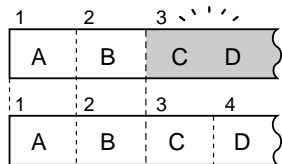

MOVE

The order of the recorded tracks can be changed. This feature is different from programme play. A new track order can be recorded directly on the disc. When the power is turned off, the revised order will not be changed.

(Page 26)

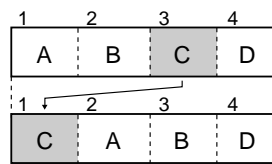

COMBINE

Two adjacent tracks (for example, the third and fourth tracks) can be combined.

If there is a prolonged silent section in the middle of a selection that is recorded, a single piece of music may be recorded as two tracks. If this happens, these two tracks can be combined into a single track.

(Page 25)

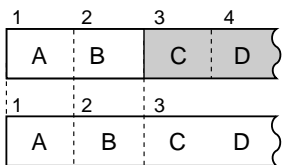

Programmed move

This function allows the track numbers to be automatically rearranged in the order specified for programmed playback. The track numbers will be adjusted as needed, automatically.

(The tracks that are not included in the programmed selections will be put at the end of the new track numbers.)

(Page 26)

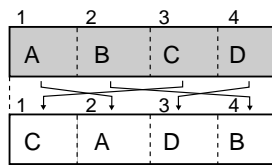

ERASE

Tracks you want to erase can be erased one at a time or all at once.

Once a track has been erased, it cannot be recovered. Double-check the track number before erasing it.

(Page 27)

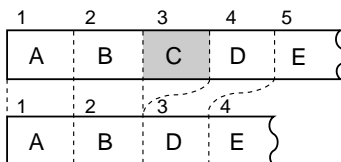

TRACK/DISC NAME

You can assign titles to recorded tracks and to discs. The characters must be capital and lowercase letters, or symbols. Track and disc names can use up to 40 characters per name.

(Page 28)

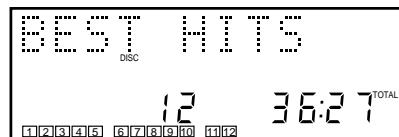

(Continued)

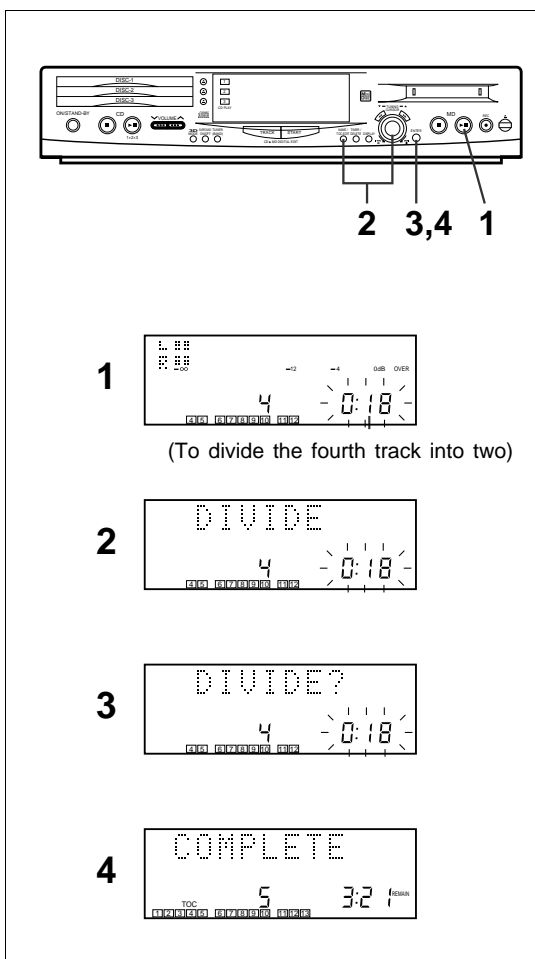

■ Divide

- 1 Play the track which you want to divide into two, and press the MD ►|| button at the point where you want to divide the track.
 - The unit will enter the pause mode.
- 2 Press the NAME/TOC EDIT button, and then select "DIVIDE" using the jog dial.
- 3 Within 10 seconds, press the ENTER button.
 - To cancel the operation, press the MD ■ button.
- 4 Press the ENTER button again.
 - The track is divided, and the unit is stopped at the beginning of the second of the two tracks.
 - The numbers of the tracks which come after the divided track are automatically increased by one.
 - When a track which has been given a name is divided, the two new tracks will have the same name and date. If the "TOC FULL" message is seen, the second track may not be given a name. (Page 39)

Notes:

- This unit can hold up to 255 tracks. However, even if the number of tracks assigned has not reached 255, it might not be possible to make any further divisions of tracks. (Page 39)
- This function cannot be used whilst a programme is being entered ("PRGM" is lit: Page 16) or whilst in the random play mode ("RANDOM" is lit: Page 15). First, cancel the programme or random play mode before trying to use this function.

(Continued)

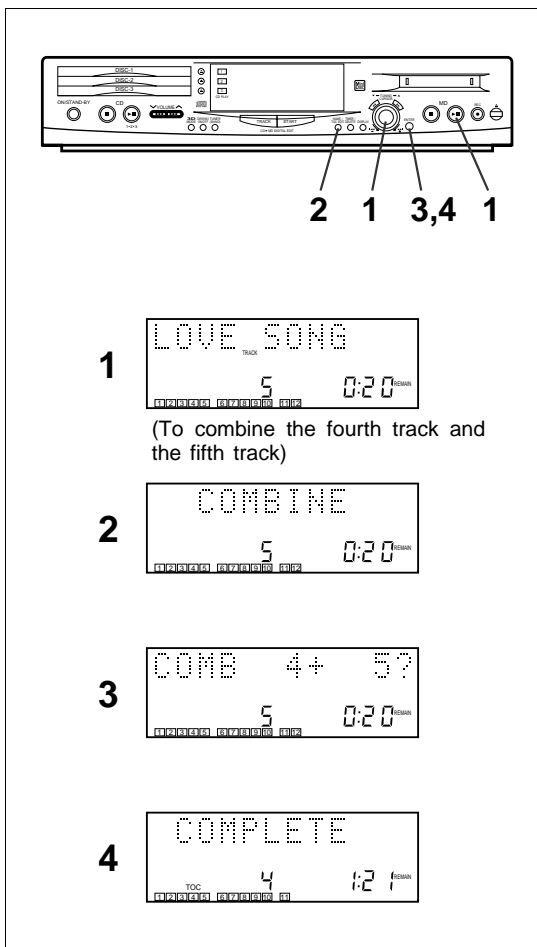

Combine

- 1 Whilst in the stop mode, select the second of the two adjacent tracks you want to combine using the jog dial.
Or start playing the second of the two tracks you want to combine, and then press the MD ►|| button.
 - The unit will enter the pause mode.
- 2 Press the NAME/TOC EDIT button, and then select "COMBINE" using the jog dial.
- 3 Within 10 seconds, press the ENTER button.
 - To cancel the operation, press the MD ■ button.
- 4 Press the ENTER button again.
 - The two tracks are combined, and the unit is stopped at the beginning of the combined track.
 - The numbers assigned to the tracks following the combined track are automatically decreased by one.

When both tracks have a name:

- When only the first track has a name → That name will be used.
- When only the second of the two tracks has a name → That name will be used.
- When both tracks have a name → The name of the first track will be used.

To combine two non-contiguous tracks:

(Example: the first and third tracks)
Move the third track to the second track using the MOVE function. (Page 26)
Then, combine the first and second tracks using the COMBINE function.

Notes:

- Tracks recorded from analogue inputs cannot be combined with tracks recorded from CDs or MDs using the digital inputs.
- Tracks recorded in the stereo mode cannot be combined with tracks recorded in the monaural long-play mode.
- Tracks where either track's recording time is less than 15 seconds may not be combined.

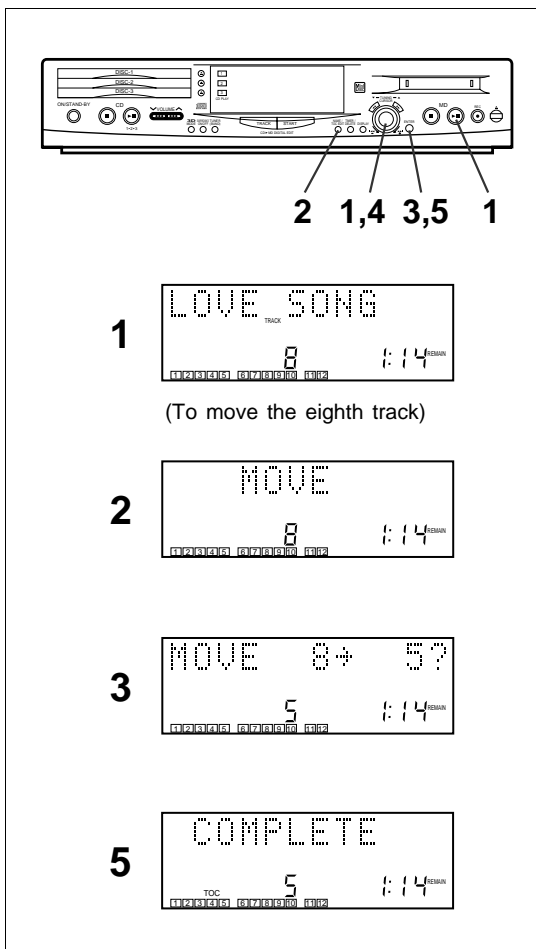
(Continued)**Move**

- 1 Whilst in the stop mode, select the track you want to move using the jog dial.
Or start playing the track to be moved, and then press the MD ►|| button.
 - The unit will enter the pause mode.
- 2 Press the NAME/TOC EDIT button, and then select "MOVE" using the jog dial.
- 3 Within 10 seconds, press the ENTER button.
- 4 Select the new track position using the jog dial.
 - To increase the track number ... ►►
 - To decrease the track number ... ◀◀
 - To cancel the operation, press the MD ■ button.
- 5 Press the ENTER button again.
 - The track is moved, and the unit is stopped at the beginning of the track.

Note:

- When a track has been moved, the other tracks which are affected will be assigned new track numbers automatically.

Example:

When moving the fifth track to the third track, the old third track will become the new fourth track, and the old fourth track will become the new fifth track.

- This function cannot be used whilst a programme is being entered ("PRGM" is lit: Page 16) or whilst in the random play mode ("RANDOM" is lit: Page 15). First, cancel the programme or random play mode before trying to use this function.

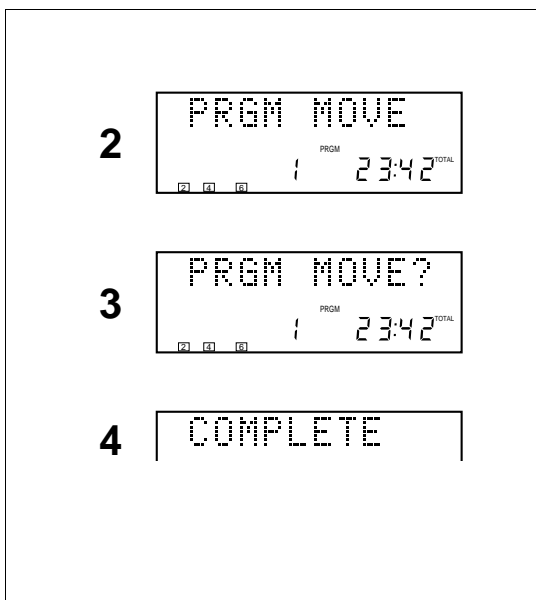
**Programmed move**

- 1 Select the tracks you want to move and enter them into a programme. (Page 16)
- 2 Make sure that the "PRGM" indicator is lit, and then press the NAME/TOC EDIT button.
 - "PRGM MOVE" will appear.
- 3 Within 10 seconds, press the ENTER button.
 - To cancel the operation, press the MD ■ button.
- 4 Press the ENTER button again.
 - The tracks will be moved, and the programmed move mode will end.

Notes:

- The tracks that are not included in the programmed selections will be put at the end of the new track numbers.
- When the same track has been entered into the programme twice or more, the last programmed position will have priority.

(Continued)

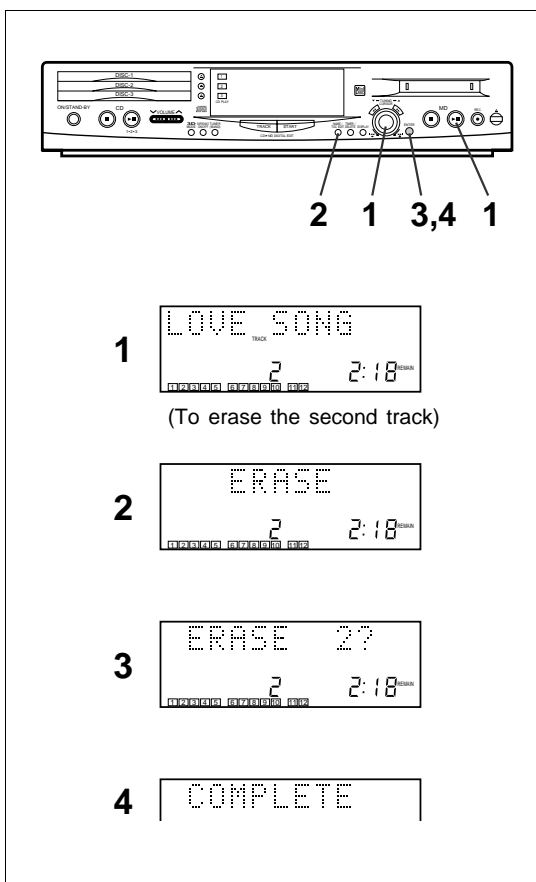

■ Erase

To erase tracks one at a time:

- 1 Whilst in the stop mode, select the track you want to erase using the jog dial.
Or start playing the track to be erased, and then press the MD ►|| button.
 - The unit will enter the pause mode.
- 2 Press the NAME/TOC EDIT button, and then select "ERASE" using the jog dial.
- 3 Within 10 seconds, press the ENTER button.
 - To cancel the operation, press the MD ■ button.
- 4 Press the ENTER button again.
 - The track is erased, and the unit is stopped at the beginning of the previous track.

Notes:

- Once a track has been erased, it cannot be recovered. Double-check the track number before erasing it.
- When a track is erased, the numbers assigned to the tracks following the erased track will be automatically decreased by one.
- When a track is erased, the track name will be erased at the same time.

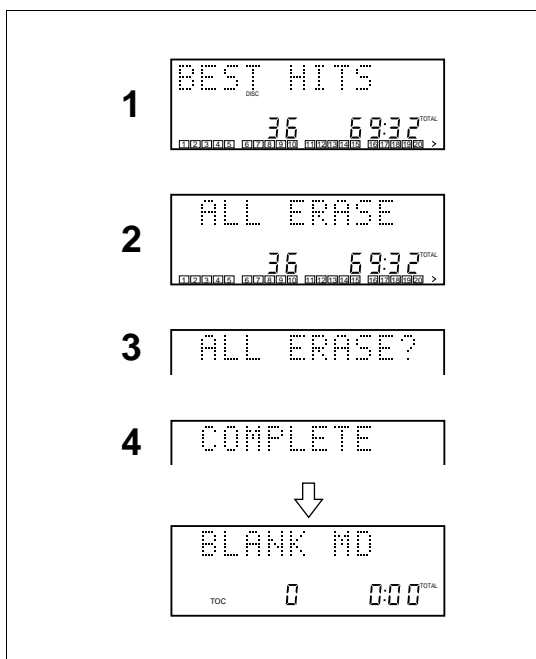

To erase all of the tracks at once:

- 1 Press the MD ■ button.
 - The total number of tracks and the total playing time for the MD will be displayed.
- 2 Press the NAME/TOC EDIT button, and then select "ALL ERASE" using the jog dial.
- 3 Within 10 seconds, press the ENTER button.
 - To cancel the operation, press the MD ■ button.
- 4 Press the ENTER button again.
 - All of the track numbers and track names will be erased.

Note:

- This function cannot be used whilst a programme is being entered ("PRGM" is lit: Page 16) or whilst in the random play mode ("RANDOM" is lit: Page 15). First, cancel the programme or random play mode before trying to use this function.

(Continued)

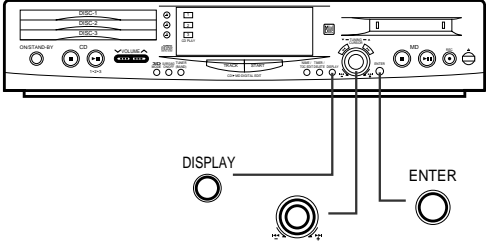

STEP 1

Each time the button is pressed, the available characters will switch as follows:

Alphabet (capital letters) ◀ ABCDE

Alphabet (lower-case letters) ◀ abcde

Numbers or symbols ◀ 12345

STEP 2

Previous character ◀ Next character

Each time the dial is turned, the cursor (■) over the character will move.

◀ ABCDE

Cursor ◀ ABCDE

◀ ABCDE

When you turn the jog dial with the cursor at the edge of the display, another 5 characters will be displayed.

◀ FGHIJ

Move the cursor to the character you want.

◀ KLMNO

STEP 3

The selected character will be entered in the character input column.

◀ KLMNO

Entering characters (Track/disc name)

- Use this section in conjunction with the sections:
To create a disc name (Page 29).
To create a track name (Page 30).
- Up to 255 tracks can be named on each disc, and each disc can be given a disc name.

When naming discs and tracks, the characters should be entered as follows:

To select the type of characters: (STEP 1)

Press the DISPLAY button.

To select characters: (STEP 2)

Select characters using the jog dial.

To enter characters: (STEP 3)

Press the ENTER button.

Repeat STEP 1 to STEP 3 as necessary to enter the characters in the name.

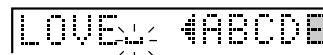

Type of characters used:

Type of characters	Characters <symbols>
Capital letters	A B C D E F G H I J K L M N O P Q R S T U V W X Y Z . , /
Lower-case letters	a b c d e f g h i j k l m n o p q r s t u v w x y z . , /
Symbols	1 2 3 4 5 6 7 8 9 0 ! " # \$ % & ' () * + , - . / : ; < = > ? @ _ `

Number of characters you can enter

Disc names and track names

Up to 40 characters (including spaces) can be entered for each name. If more than 40 characters are entered, "NAME FULL" will appear.

Total number of characters per MiniDisc

A total of approximately 1700 characters can be used for all of the disc and track names. If more than 1700 characters are entered, "TOC FULL" will appear.

(Continued)

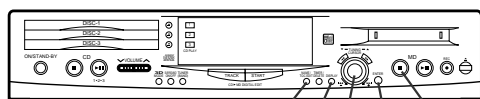

2,7 4 5 3,6 1

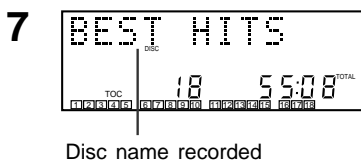
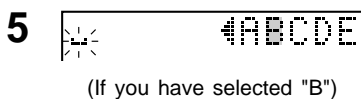
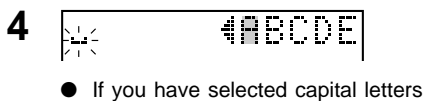
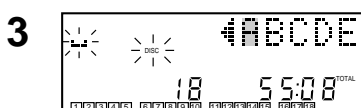
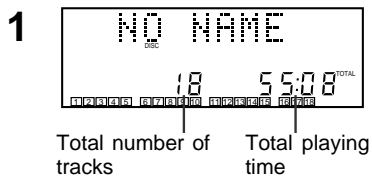

■ To create a disc name

A name for the whole disc. Disc names are displayed when an MD is inserted.

- 1** Press the MD button.
 - The total number of tracks and the total playing time for an MD will appear.
- 2** Press the NAME/TOC EDIT button, and then select "DISC NAME" using the jog dial.
- 3** Within 10 seconds, press the ENTER button.
 - The unit will enter the character input mode.
- 4** Press the DISPLAY button to select the type of characters you want to use. (Page 28)
- 5** Select the character you want using the jog dial.
- 6** Press the ENTER button to enter the character.
 - Repeat steps 4 to 6 above to enter the characters in the name. When the next character's type is the same as the previous character, step 4 can be skipped.
- 7** After entering all of the characters in the name, press the NAME/TOC EDIT button.
 - The disc name will be recorded.

Note:

- This function cannot be used whilst a programme is being entered ("PRGM" is lit: Page 16) or whilst in the random play mode ("RANDOM" is lit: Page 15). First, cancel the programme or random play mode before trying to use this function.



(Continued)

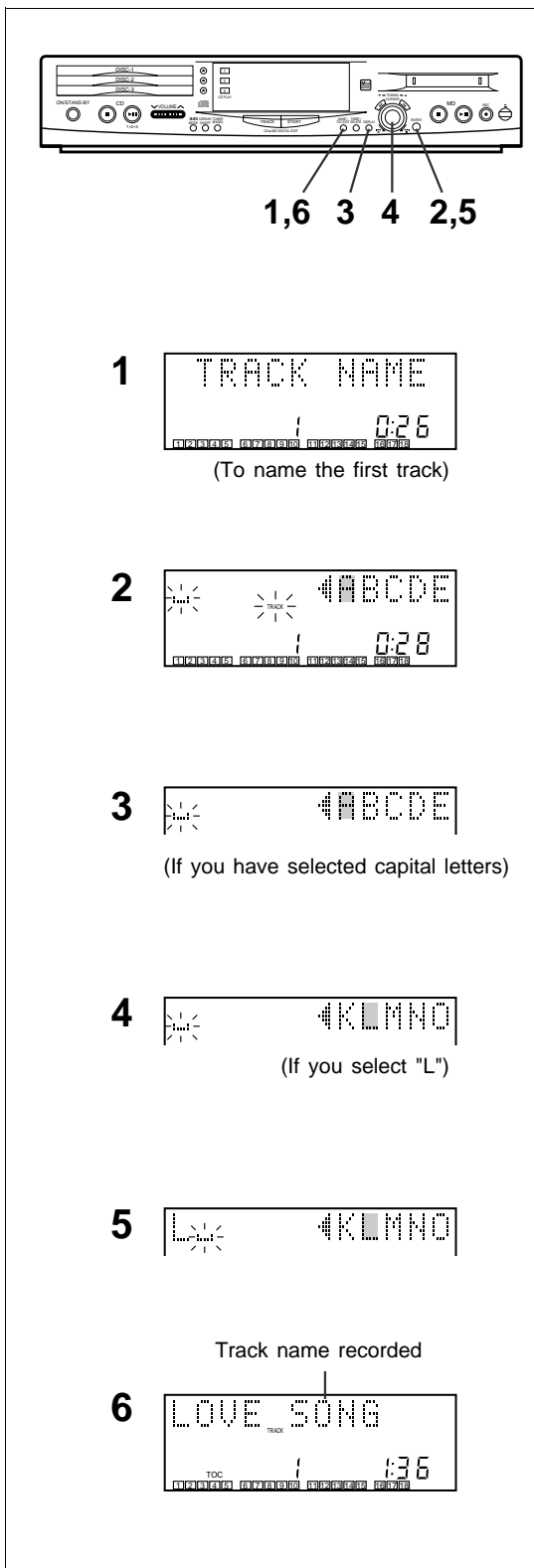

■ To create a track name

Name each track.
A track's name will be displayed whenever you select it and during playback.

- 1** During playback, press the NAME/TOC EDIT button.
 - "TRACK NAME" will appear.
- 2** Within 10 seconds, press the ENTER button.
 - The unit will enter the character input mode.
 - The track you are listening to will be played repeatedly.
- 3** Press the DISPLAY button to select the type of characters. (Page 28)
- 4** Select the character you want using the jog dial.
- 5** Press the ENTER button to enter the character.
 - Repeat steps 3 to 5 above to enter the characters in the name. When the next character's type is the same as the previous character, step 3 can be skipped.
- 6** After entering all of the characters in the name, press the NAME/TOC EDIT button.
 - The track name will be recorded.
 - The unit will return to normal playback.

Notes:

- This function cannot be used whilst a programme is being entered ("PRGM" is lit: Page 16) or whilst in the random play mode ("RANDOM" is lit: Page 15). First, cancel the programme or random play mode before trying to use this function.
- The track name function can be used whilst in the stop mode (when selecting a track), in the pause mode, or in the recording mode. (Select "TRACK NAME" from the edit menu.)
- If you create a track name whilst recording the track, make sure you finish entering the name before you finish recording the track.
If the end of the recording is reached before you have entered the complete name, only the characters entered before the recording ended will be recorded.

(Continued)**■ To change disc names and track names****To change disc names:**

- 1 During playback, press the MD ■ button.
- 2 Press the NAME/TOC EDIT button, and then select "DISC NAME" using the jog dial.
- 3 Within 10 seconds, press the ENTER button.
 - The unit will enter the character input mode.
 - To cancel the operation, press the MD ■ button.

Now you can erase or add characters. (Page 32)

To change track names:

- 1 Whilst in the stop mode, select the track name you want to change, using the jog dial.
- 2 Press the NAME/TOC EDIT button.
- 3 Within 10 seconds, press the ENTER button.
 - The unit will enter the character input mode.
 - To cancel the operation, press the MD ■ button.

Now you can erase or add characters. (Page 32)

(Continued)

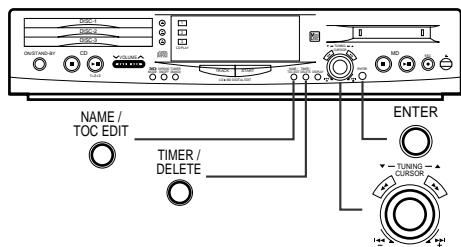

4 (To erase the letter "U")

5 ● The character will disappear.

6

4 (To add a character to left of the "S")

5 (To add the letter "E")

● The original characters will move to the right by one.

6

To erase a character:

After performing steps 1 to 3 on page 31, do the following:
Example: To change "BESUT" to "BEST"

- 4** Press the ◀◀/▶▶ button to make the character you want to erase begin flashing.
- 5** Press the TIMER/DELETE button.
- 6** Press the NAME/TOC EDIT button.

To add a character:

After performing steps 1 to 3 on page 31, do the following:
Example: To change "BST" to "BEST"

- 4** Press the ◀◀/▶▶ button to make the character at the place you want to add a letter begin flashing.
- 5** Select the character you want to add, using the jog dial. Then, press the ENTER button.
- 6** Press the NAME/TOC EDIT button.

■ To correct a spelling

After putting the unit in the character input mode, erase the wrong character. Then, enter the correct character.

■ To erase disc names or track names

After performing steps 1 to 3 on page 31, do the following:
Press the TIMER/DELETE button for at least 2 seconds, and then press the ENTER button.

- The disc or track name will be erased.

HOW TO USE THE BUILT-IN TIMER

- Before setting the timer, make sure that the clock setting is correct. (Page 6)
- The start time and stop time, which are set with this operation, will be kept in memory until the AC power lead is unplugged or the setting is changed.

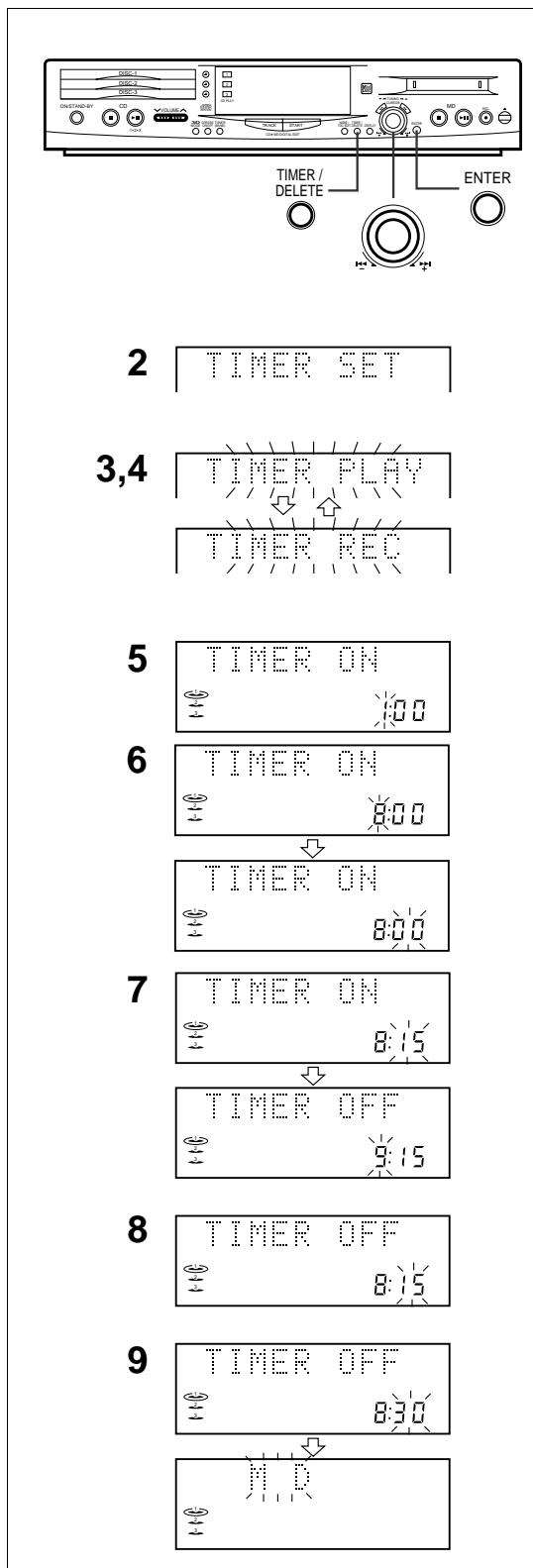

■ To select the timer playback mode

Before timer playback, the following preparations are required.

- Load a CD or MD
- Select a CD to be played.
- Preset the radio station.

- 1 Press the TIMER/DELETE button.
 - 2 Turn the jog dial so that the "TIMER SET" display appears.
 - 3 Within 10 seconds, press the ENTER button.
 - 4 Select the timer mode using the jog dial.
 - 5 Press the ENTER button.
- The start time setting display will appear.

■ To select the timer recording mode

Before timer recording, the following preparations are required.

- Load a recordable MD
- Preset the radio station.

- 1 Press the TIMER/DELETE button.
 - 2 Turn the jog dial so that the "TIMER SET" display appears.
 - 3 Within 10 seconds, press the ENTER button.
 - 4 Select the timer mode using the jog dial.
 - 5 Press the ENTER button.
- The start time setting display will appear.

■ To set the start time and the stop time

- 6 Turn the jog dial to set the hour at which to start, and then press the ENTER button.
 - 7 Turn the jog dial to set the minute at which to start, and then press the ENTER button.
- If not set manually, the ending time will be automatically set for one hour after the starting time.
- 8 Turn the jog dial to set the hour at which to stop, and then press the ENTER button.
 - 9 Turn the jog dial to set the minute at which to stop, and then press the ENTER button.

(Continued)

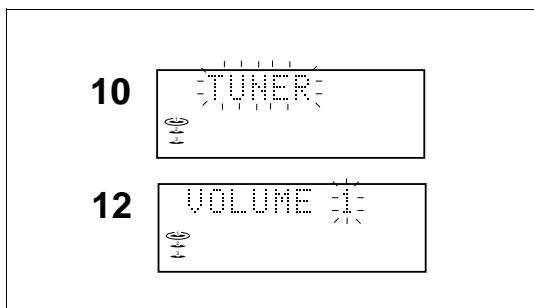

Function selection/volume adjustment

10 Turn the jog dial to select the function.

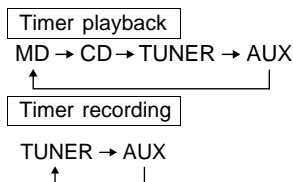

● If TUNER is selected, press the ENTER button then select the preset number using the jog dial.

11 Press the ENTER button.

12 Adjust the sound level using the jog dial.

13 Press the ENTER button.

● Be careful not to turn the volume up too high. (When the start time is reached in timer playback, the volume will increase gradually to the level previously set.)

To change the programmed contents:

Turn the power on and start again from step 1.

To check the timer setting:

- 1** Whilst in the timer standby mode, press the TIMER/DELETE button.
- 2** Turn the jog dial so that the "TIMER CALL" display appears.
- 3** Within 10 seconds, press the ENTER button.
 - The timer settings will appear in order, and then the original display will reappear.

To cancel the timer operation:

If the power is turned on, the timer will be cancelled. The timer operation can also be cancelled as follows.

- 1** Whilst in the timer standby mode, press the TIMER/DELETE button.
- 2** Turn the jog dial so that the "TIMER CANCEL" display appears.
- 3** Within 10 seconds, press the ENTER button.
 - The timer operation will be cancelled ("TIMER" or "TIMER REC" will go off.) The start and stop times will be stored.

Notes:

- When the CD or MD is played to the end, playback will stop before the stop time. If you wish to play to the stop time, set repeat play for the CD or MD.
- Timer recording starts about 15 seconds before the start time.

Caution:

In the following cases, the timer recording function will not work

- When a MiniDisc has not been inserted
- When a playback-only MiniDisc is inserted
- When the MiniDisc you inserted is protected against accidental erasure
- When there is no recording space left on the MiniDisc you have inserted (when the "TOC FULL" or "DISC FULL" messages appear)

To cancel timer setting:

Press any button other than the jog dial or the ENTER button.

Notes:

- The programmed contents will remain in memory until they are changed.
- Timer playback and timer recording with this unit cannot be used to control equipment connected to this unit. You must use the timer of the other equipment, if it has one.
- The timer playback and timer recording functions cannot be used at the same time.
- The date of timer playback or timer recording cannot be assigned.

Setting timer playback or timer recording

- 1** Press the TIMER/DELETE button.
 - Turn the jog dial so that the "T-STANDBY" display appears.
 - If the start and stop times have not been set the "T-STANDBY" display does not appear. Set the time.
- 2** Press the ENTER button.
 - The settings will appear in order, and the unit will enter the timer playback or timer recording standby mode. (The power will be turned off.)

(Continued)

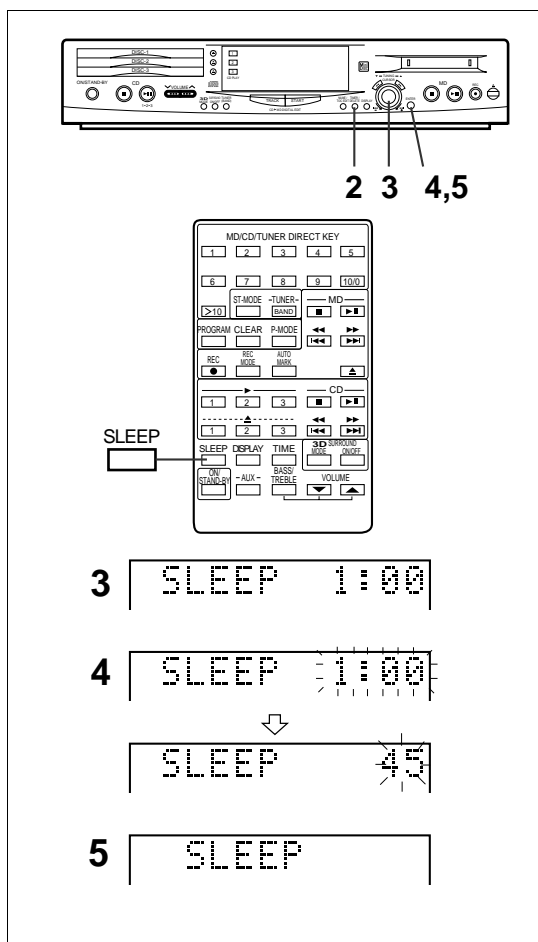

To set or cancel the sleep operation using the remote control:

Press the SLEEP button.

To cancel the sleep operation:

Press the SLEEP button twice.

Note:

- The sleep time cannot be set using the remote control.

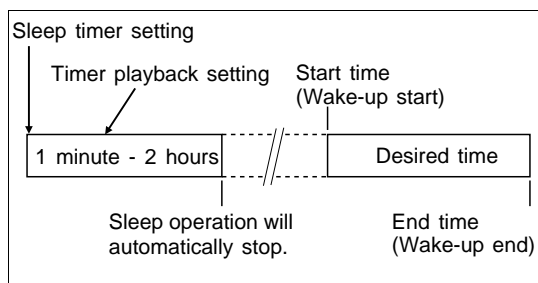

■ Sleep operation

The radio, compact disc and MiniDisc can all be turned off automatically.

- 1 Play back the desired sound source.
- 2 Press the TIMER/DELETE button.
- 3 Turn the jog dial so that the "SLEEP" display appears.
- 4 Within 10 seconds, press the ENTER button.
 - If you do not need to change the time, go to step 5.

To change the sleep time:

Whilst the sleep time is displayed, turn the jog dial to adjust the time.

(Maximum: 2 hours - Minimum: 1 minute)

The amount of sleep time can also be changed during the sleep operation.

- 2 hours - 5 minutes → 5-minute intervals
- 5 minutes - 1 minute → 1-minute intervals

- 5 Press the ENTER button.

- 6 The unit will turn off automatically after the preset sleep time has elapsed.

- The volume will decrease gradually 1 minute before the preset sleep time has elapsed. At this time, you cannot change the volume.

To confirm the sleep timer setting:

- 1 Press the TIMER/DELETE button.
- 2 Turn the jog dial so that the "SLEEP OFF" display appears.

To cancel the sleep operation:

If the power is turned off, the sleep operation will be cancelled. The timer operation can also be cancelled as follows if the power cannot be turned off during recording.

- 1 Press the TIMER/DELETE button.
- 2 Turn the jog dial so that the "SLEEP OFF" display appears.
- 3 Within 10 seconds, press the ENTER button.
 - The sleep operation will be cancelled. ("SLEEP" will go off.)

Notes:

- Once the sleep time is set, it will remain the same duration until the setting is changed.
- This sleep functions of this unit cannot be used to control equipment connected to this unit. You must use the sleep functions of the other equipment, if it has them.

■ Simultaneous sleep and timer operation

- 1 Play the desired item (compact disc, MiniDisc, etc.).
- 2 Set the sleep timer.
- 3 Set timer playback.
- 4 When the preset sleep time has elapsed, the power will be automatically turned off. When the timer start time is reached, the power will be turned on again.

Note:

- The unit can also be used by a combination of the sleep timer and timer recording function.

USING EXTERNAL UNITS

■ Connecting external units

Before starting operation:

- Before connecting external units, turn off the power to each external unit.
- Connect each plug completely. If the units are not connected correctly, it may not be possible to record or playback properly.
- Recordings made from other equipment are made through an analogue connection.

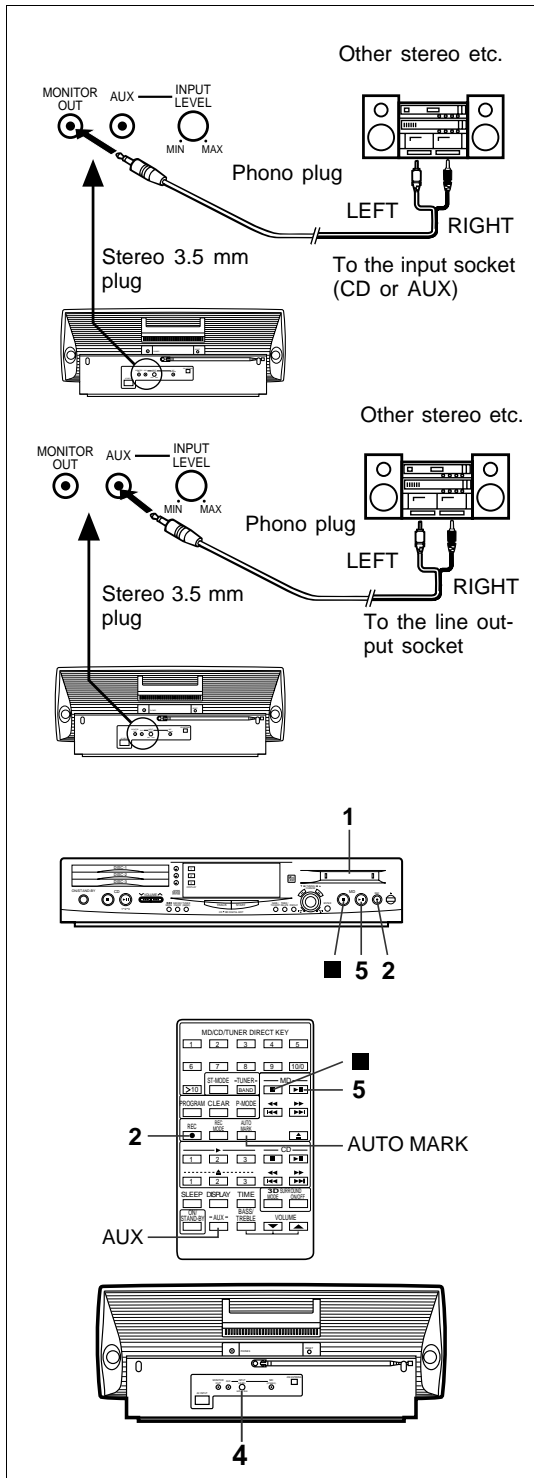

■ Monitor output

To listen to the playback from this unit through other equipment

Connect the MONITOR OUT socket to the input of the other equipment using an RCA lead.

- Commercially available lead with a stereo plug and phono plug.

Note:

- The output of "MONITOR OUT" is fixed. The output is not affected by the adjustment of the volume or tone controls.

■ Auxiliary input

To listen to playback from other equipment or record it through this unit

Connect the AUX socket to the input of the other equipment using an RCA lead.

- Commercially available lead with a stereo plug and phono plug.

Listening to sound from an external unit

- 1 Press the AUX button on the remote control.
- 2 Start playback on the external unit.
- 3 Adjust the sound level using the VOLUME buttons of this unit.

Recording sound from an external unit

- 1 Load a recordable MiniDisc.
 - 2 Press the REC ● button.
 - 3 Start playback on the external unit.
 - 4 Adjust the recording level using the INPUT LEVEL control when signals are to be recorded.
- The maximum level should not exceed 0 dB.
 - 5 Press the MD ►|| button.
 - Recording will begin.

To stop recording:

Press the MD ■ button.

To interrupt recording:

Press the MD ►|| button during recording. Press the MD ►|| button again to resume recording. The track number increases.

(Continued)

■ To create track numbers automatically

Before recording, press the AUTO MARK button on the remote control.

- Track numbers are automatically created with a blank space of at least 1.5 seconds between tracks. (Auto marker function)
If there is too much noise, track numbers may not be created.
- "A.MARK ON" will appear.

■ To record tracks as a single track

You can record several pieces of music as a single track by disabling using the auto marker function.

Before recording, press the AUTO MARK button on the remote control.

- "A.MARK OFF" will appear.

Note:

- If the recording level is too low, the sound becomes quieter. If it is set too high, distortion increases.
Since CDs and DATs are digitally recorded and have a wide dynamic range, be careful not to increase the recording level too much.

Connect a separately available stereo microphone and set the input to AUX.

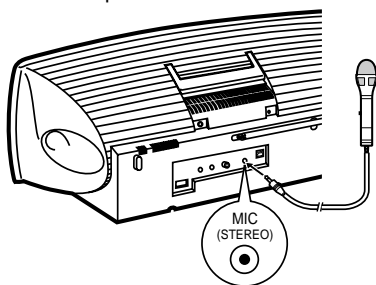

■ Using the microphone

Press the AUX button on the remote control.

The microphone volume should be adjusted using the INPUT LEVEL control.

- The method of recording/playing back the sound from a microphone is the same as that from analogue inputs.
- When a microphone is connected, recording/playback from other analogue inputs is not possible.
- This unit does not allow you to mix playback sound with the sound picked up by the microphone.
- When you use a monaural microphone, recording/playback is available only on the left channel. To record/play back on the left and right channels, set the record mode to "MONO".

■ Headphones

- Be sure that your headphones have a 3.5 mm (1/8") diameter plug and are between 16 ohms and 50 ohms impedance. The recommended impedance is 32 ohms.
- When headphones are connected, the speakers are disconnected automatically. Adjust the VOLUME control for desired volume.

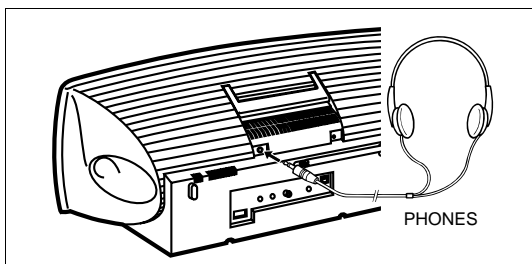

WHAT IS A MINIDISC?

The disc is stored in a cartridge. You can handle it easily without worrying about dust, fingerprints, etc. However, dust entering the opening of the cartridge, dirt on the cartridge, warping, etc. may cause malfunctions. Please note the following.

■ Handling the MiniDisc

Do not touch the disc directly!

Do not open the shutter or touch the disc directly. If the shutter is opened forcibly, it may break.

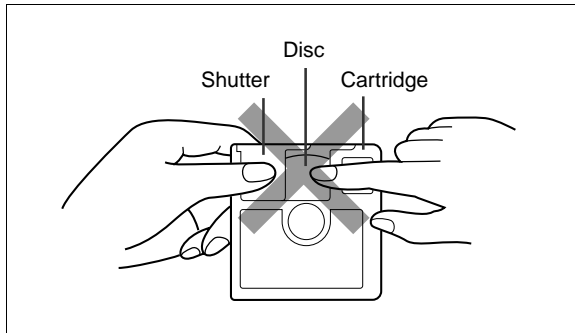

Where not to store discs:

Do not store discs in places with high temperatures or humidity. Specifically, do not leave discs in places exposed to direct sunlight or in cars with doors and windows closed. Do not leave discs in places where sand can get into the cartridge easily (e.g., beaches).

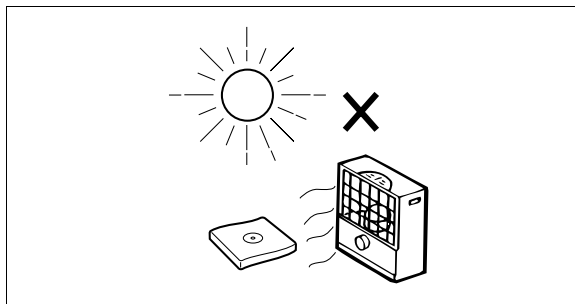

Regular cleaning:

If the outside surface of the cartridge becomes dusty or dirty, clean it with a dry cloth.



■ To prevent recorded discs from being erased accidentally (accidental erasure prevention)

Slide the accidental erase prevention tab, located on the side of the disc, in the direction indicated by the arrow.

- The disc will then be protected against accidental erasure.
- To add a recording to such a disc, slide the accidental erase prevention tab back to its original position.

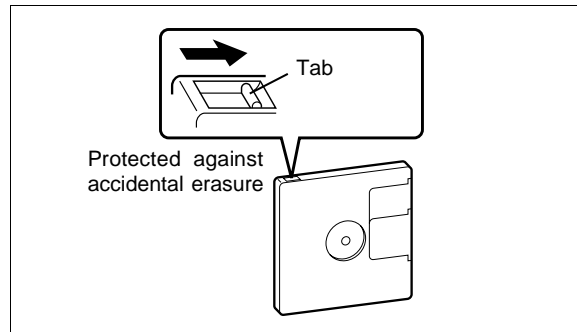

■ What is a MiniDisc?

- A MiniDisc is a 64 mm (2-1/2") diameter disc which is stored in a cartridge. MiniDiscs are easy to handle, compared to compact discs, because they are protected against dust and scratches.
- Recording and playback use a digital system with a sound quality that is similar to that found on compact discs. MiniDiscs cannot twist or stretch like tapes. The quality of sound will not deteriorate. MiniDiscs are extremely durable.
- Never disassemble MiniDiscs.

■ Adaptive Transform Acoustic Coding [ATRAC]

The ATRAC (Adaptive TRansform Acoustic Coding) is a new technology that is designed to eliminate the information in sounds which you can not hear and to compress the remaining sound data so that the recording uses about 1/5 of the original sound information. Sound data is analysed and filtered to take advantage of psycho acoustic masking. The acoustic quality of the sound is not impaired.

(Continued)

Types of discs

There are two types of discs: playback-only and recordable type.

- **Playback-only MiniDisc:**
This type of MiniDisc is used for commercially available pre-recorded music. This is the same kind of optical disc as CDs. Playback is performed using an optical pickup. (Recording and editing are not possible.)

A Shutter will be used on only one side (back).

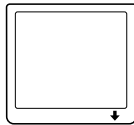

- **Recordable MiniDisc:**
This is a "raw disc" on which recording can be performed. A magneto optical disc is used. Recordings are made using a laser and magnetic field. Repeated recording is possible.

Shutters will be used on both sides.

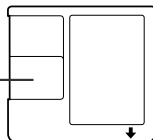

Shock Resistant Memory

During playback, approximately 10 seconds of information is stored in the semiconductor memory. Therefore, even when the pickup cannot read information for a second or two due to an external shock, the sound continues without interruption because the information stored in memory is output.

How to apply labels

When sticking a label on an MD cartridge, be sure to observe the following. If a label is not affixed properly, an MD may become jammed in the unit such that it can not be removed.

- Stick a label correctly to the specified area. (Do not stick labels to areas other than the specified one.)
- Do not stick one label upon another.
- If a label is peeling off or starts to come loose, replace it with a new one.

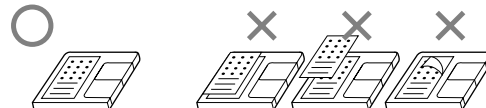

High-speed access

A unique feature of the MiniDisc is the ability to locate the beginning of a desired track at high speed. This is because the track number and track name data is stored in a TOC (Table of Contents).

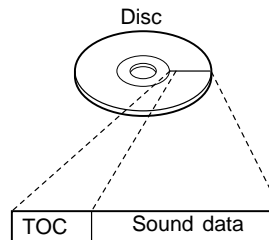

MINIDISC SYSTEM LIMITATIONS

Even if the maximum recording time of a MiniDisc has not been reached, "TOC FULL" may be displayed.	In the MD system, the delimiter of the recording area on an MD is programmed in a TOC. If partial erasing, recording and editing are repeated several times, TOC information will fill up, even though the number of tracks has not reached the limit (255 tracks), and further recording will be impossible. (If you use the all erase function, this MD can be used from the beginning.)
Even if the maximum recording time of a MiniDisc has not been reached, "DISC FULL" may be displayed.	If there is any flaw on the MiniDisc, that part is automatically excluded from the space available for recording. Therefore, the recording time becomes shorter.
Even if several short tracks are erased, the remaining recording time may not show an increase.	When the remaining recording time of a disc is displayed, short tracks less than 12 seconds long may not be included in the total.
Two tracks may not be combined in editing.	For MiniDiscs on which repeated recording and editing operations were performed, the COMBINE function may not work. A track recorded from a CD (digital recording) and a track recorded from a radio or other equipment (analogue recording) cannot be combined.
The total of the recorded time and time remaining on a disc may not add up to the maximum possible recording time.	A cluster (about 2 seconds) is normally the minimum unit of recording. So, even if a track is less than 2 seconds long, it will use about 2 seconds of space on the disc. Therefore, the time actually available for recording may be less than the remaining time displayed. If there are scratches on discs, those sections will be automatically avoided (no recording will be placed in those sections). Therefore, the recording time will be reduced.
If recorded tracks are fast reversed or fast forwarded, the sound may skip.	An MD which was recorded or edited repeatedly may skip during fast reverse or fast forward.

TROUBLESHOOTING

■ If a problem occurs

If this unit functions abnormally during operation, first check the following items. If the unit continues to function abnormally, or if an abnormality appears other than listed below, turn off the player's power and disconnect the AC power plug, then consult your SHARP dealer or service personnel.

●General

SYMPTOM	POSSIBLE CAUSE	REMEDY
● The clock is wrong.	● Did a power failure occur?	● Try setting it again.
● When a button is pressed, the unit does not respond.		● Turn the power off and on again, and then retry the operation.
● No sound is heard.	● Is the volume level is set to "0"? ● Are the headphones connected?	● Increase the volume level. ● Disconnect the headphones.
● Radios make unusual noise or the picture on the TV screen is distorted.	● When a radio or TV which uses an indoor aerial is placed near the unit, the picture on the TV screen may be distorted or the radio may not function properly.	● It is recommended that you use an external aerial.

●CD playback

SYMPTOM	POSSIBLE CAUSE	REMEDY
● Even though a disc has been loaded, "NO DISC" or "ERROR" is displayed.	● The disc is loaded up-side down. ● The disc is very dirty. ● The disc which does not satisfy the standards.	● Load the disc with the correct side up. ● Clean the disc. ● Load the correct disc.
● Playback stops in the middle of a track, or playback is not performed properly.	● Is the unit located near excessive vibrations?	● Place the unit on a firm, level surface free from vibration.
● Playback sounds are skipped.	● Has condensation formed inside the unit?	● Remove the disc and leave the power turned on. The unit should function properly in about 1 hour.

●MD recording and playback

SYMPTOM	POSSIBLE CAUSE	REMEDY
● A recording cannot be made.	● Is the MiniDisc protected against accidental erasure? ● Did you try to make recording on a playback-only MiniDisc? ● Can you see the "TOC FULL" message in the display?	● Slide the accidental erase prevention tab back to its original position. ● Replace it with a recordable disc. ● Put in another recordable disc with recording space on it.
● Even though a disc has been loaded, "NO DISC" or "ERROR" is displayed.	● The disc is very dirty. ● Is the unit located near excessive vibrations?	● Clean the disc. ● Place the unit on a firm, level surface free from vibration.
● Playback sounds are skipped.	● Has condensation formed inside the unit?	● Remove the disc and leave the power turned on. The unit should function properly in about 1 hour.

●Radio reception

SYMPTOM	POSSIBLE CAUSE	REMEDY
● Radios make unusual noise consecutively.		● When the unit receives a radio broadcast near a TV set, a computer or a wordprocessor, it may pick up noise. If this happens, try to move the unit from the place where the noise is picked up.
● The preset channel cannot be called.	● Did a power failure occur?	● Preset the channel again.

●Remote control

SYMPTOM	POSSIBLE CAUSE	REMEDY
● The remote control does not function or does not operate properly.	● The batteries (polarity) are not inserted properly. ● The batteries inside the remote control are dead. ● The remote control is operated from an incorrect distance or angle.	● Insert properly. ● Replace the batteries. ● Operate it within a range of 0.2 m (8") to 6 m (20') and within an angle of 15° to either side of centre.
● The power cannot be turned on from the remote control.	● Is the AC power lead plugged in?	● Connect the AC power lead.

(Continued)

When an error message is displayed, proceed as follows:

Error messages	Meaning	Remedy
BLANK MD	● Nothing is recorded.	● Replace the disc with a recorded disc.
Can't COPY	● You tried to record from a copy-protected disc.	● Replace it with a regular disc that can be copied.
Can't EDIT	● A track cannot be edited.	● Change the stop position of the track and then try editing it.
Can't REC	● Recording cannot be performed correctly due to vibration or shock in the unit.	● Re-record.
Can't T REC	● Timer recording is impossible or there is no available space on the MD.	● Replace it with another disc.
CH ERROR	● There is something wrong with the CD changer.	● Turn the power off and then back to on, and press the ► button.
DEFECT	● Since this disc has scratches on it, the recording operation was skipped.	● Replace the disc with another recordable disc.
DISC ERR	● The disc is damaged. ● A TOC is not written on the MD or there is something wrong with data.	● Reload the disc or replace it.
DISC FULL	● The disc is out of recording space.	● Replace the disc with another recordable disc.
EDIT OVER	● There is no space to make CD editing on the disc.	● Replace it with a disc that has enough time to record.
MD ERROR	● No operation	● Contact the shop where you purchased the unit.
MECHA ERR* (*: Number or symbol)	● There is a mechanical problem and the disc is not working properly.	● Turn off the power, and press the ▲ button.
NAME FULL	● The number of characters for the disc name or track name exceeds 40.	● Shorten the disc or track name.
NO DISC	● A disc has not been loaded. ● The disc data cannot be read.	● Load a disc. ● Reload the disc.
NOT AUDIO	● The data recorded on this disc is not audio data.	● Select another track. ● Replace the disc.
PLAYBACK MD	● You tried to record on a playback-only disc.	● Replace it with a recordable disc.
PROTECTED	● The disc is write protected.	● Move the write protection tab back to its original position.
TEMP OVER	● The temperature is too high.	● Turn off the power, and wait for a while.
TOC ERR* (*: Number or symbol)	● The disc is damaged. ● TOC information cannot be read. ● MD not specified.	● Replace it with another disc.
TOC FULL* (*: Number or symbol)	● There is no space to programme track numbers.	● Replace it with another recordable disc.
TOC FULL 1	● There is no space left for recording character information (track names, disc names, etc.).	● Replace it with another recordable disc.
TOC W ERROR	● Recording is impossible.	● Contact the shop where you purchased the unit.
TRAY ERROR	● The CD tray operates incorrectly.	● Unplug the AC power lead, plug it back, and then turn the power on.
U TOC ERR* (*: Symbol)	● TOC information recorded on the MD does not match the MD specifications or it cannot be read.	● Replace it with another disc. ● Erase all of the tracks, and try recording.
U TOC W ERR	● The TOC information could not be created properly due to a mechanical shock or to scratches on the disc.	● Turn off the power, and try to write the TOC again. (Remove any source of shock or vibration whilst writing.)
? DISC	● The data contains an error.	● Replace it with another disc.
0 0:00	● Music is not being recorded.	● Replace the disc with another recordable disc.

(Continued)

■ Moisture condensation

In the following cases, condensation may form inside the unit.

- Shortly after turning on a heater.
- When the unit is placed in a room where there is excessive steam or moisture.
- When the unit is moved from a cool place to a warm place.

When the unit has condensation inside, the disc signals cannot be read, and the product may not function properly.

- If this happens, remove the disc. The condensation should evaporate in approximately 1 hour. The unit will then function properly.

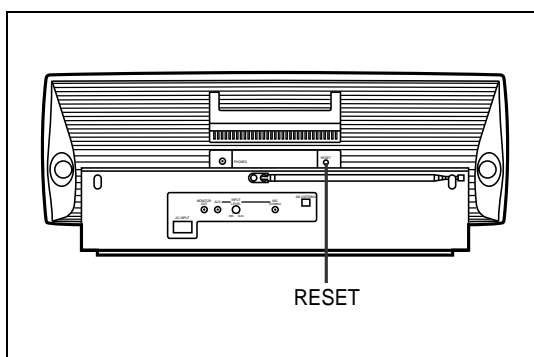

■ If a problem occurs

If this product is subjected to strong external interference (mechanical shock, excessive static electricity, abnormal supply voltage due to lightning, etc.) or if it is operated incorrectly, it may malfunction or the display may not function correctly. If such a problem occurs, do the following:

Connect the AC power lead to the AC socket, and press the RESET button once on the rear of the main unit.

- When the RESET button is pressed, all of the settings in memory will be erased.
- If strange sounds, smells or smoke come out of the unit or if a foreign object falls into the unit, turn off the power, unplug the AC power lead from the AC socket, immediately. Contact the shop where you purchased the unit.

TRANSPORTING THE UNIT

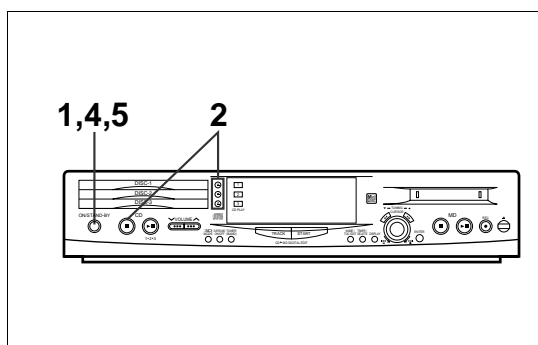

Before you move this product to a new location, proceed as follows:

- 1** Set the ON/STAND-BY switch to ON.
- 2** Press the CD ■ button.
 - Remove all CDs inserted in the unit.
- 3** Press the RESET button once on the rear of the main unit.
- 4** Make sure "TIME ADJUST" appears on the display of the CD/MD combination, then set the ON/STAND-BY switch to ON again.
 - Make sure that "NO DISC" is displayed.
- 5** Set the ON/STAND-BY switch to STAND-BY.
- 6** Make sure the indication in the display of the CD/MD combination has changed as from "GOOD BYE!" into "TIME ADJUST", and then unplug the AC power lead from the AC socket.

MAINTENANCE

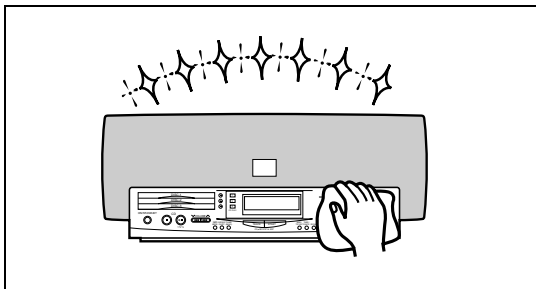

External care

- Periodically wipe the cabinet with a soft cloth and a diluted soap solution, then wipe with a dry cloth.
- Do not use chemically treated cleaning cloths or other chemicals.

SPECIFICATIONS

As a part of our policy of continuous improvement, SHARP reserves the right to make design and specification changes for product improvement without prior notice. The performance specification figures indicated are nominal values of production units. There may be some deviations from these values in individual units.

(MiniDisc recorder section)

Type:	MiniDisc recorder
Signal readout:	Non-contact, 3-beam semi-conductor laser pickup
Rotational speed:	400 - 900 rpm CLV, Approx
Error correction:	ACIRC (Advanced Cross Interleave Reed-Solomon Code)
Quantization:	16 bit linear
Coding:	ATrac (Adaptive TRansformed Acoustic Coding)
Sampling frequency:	44.1 kHz
Recording method:	Magnetic modulation overwrite method
Filter:	8-times oversampling digital filter
Frequency response:	20 - 20,000 Hz (+0/-2 dB)
D/A converter:	1-bit D/A converter
Signal/noise ratio:	95 dB (1 kHz)
Dynamic range:	90 dB (1 kHz)
Wow and flutter:	Unmeasurable (less than 0.001% W. peak)
Audio channel:	Stereo 2 channel
T.H.D at 1 kHz:	0.1 %

(Compact disc player)

Type:	3-disc multi-play compact disc player
Signal readout:	Non-contact, 3-beam semi-conductor laser pickup
Rotational speed:	200 - 500 rpm CLV, Approx.
Error correction:	CIRC (Cross Interleave Reed-Solomon Code)
Quantization:	16 bit linear
Filter:	8-times oversampling digital filter
Frequency response:	20 - 20,000 Hz (+0/-2 dB)
D/A converter:	1-bit D/A converter
Signal/noise ratio:	95 dB (1 kHz)
Dynamic range:	90 dB (1 kHz)
Wow and flutter:	Unmeasurable (less than 0.001% W. peak)

(Tuner section)

Frequency range:	FM; 87.5 - 108 MHz AM; 522 - 1,620 kHz
Sensitivity:	FM; 2.5 μ V AM; 800 μ V/m

(General)

Power source:	AC 230 V, 50 Hz
Power consumption:	69 W
Output power:	● For European customers PMPO; 90 W MPO; 21 W (10.5 W + 10.5 W) (DIN 45 324) RMS; 15 W (7.5 W + 7.5 W) (DIN 45 324) ● For U.K. customers MPO; 21 W (10.5 W + 10.5 W) (10 % T.H.D.) RMS; 15 W (7.5 W + 7.5 W) (10 % T.H.D.)
Input terminals:	Auxiliary (analogue); 280 mV/47 kohms Microphone; 600 ohms
Output terminals:	Headphones; 16 - 50 ohms (recommended; 32 ohms) Monitor output; 1.7 V (1 kohm)
Dimensions:	Width; 550 mm (21-11/16") Height; 219 mm (8-5/8") Depth; 309 mm (12-3/16")
Weight:	7.6 kg (16.8 lbs.)

(Timer/clock)

Type:	Digital clock with date function
Timer:	ON/OFF, once a day

SHARP
SHARP CORPORATION

TINSZ0217AWZZ

A9703.SM

MD-ZV30H TINSZ0217AWZZ