

MDS-SP55

SERVICE MANUAL

Self Diagnostics
Supported model

Ver 1.1 2001.06



AEP Model
UK Model
E Model

MDS-SP55 is the MD section in CMT-SP55MD,
and MDS-SP55 is sold in the option as a
minidisk deck of CMT-SP55TC.

US and foreign patents licensed from Dolby Laboratories
Licensing Corporation.

Model Name Using Similar Mechanism	MDS-JE330
MD Mechanism Type	MDM-5A
Optical Pick-up Type	KMS-260B/S1NP

SPECIFICATIONS

System MiniDisc digital audio system
Laser Semiconductor laser ($\lambda=780$ nm)
Emission duration: continuous
Laser output Max. 44.6 μ W*
*This output is the value
measured at a distance of 200 mm
from the objective lens surface on
the Optical Pick-up Block with
7 mm aperture.
Sampling frequency 44.1 kHz
Frequency response 20 Hz – 20 kHz
Inputs
DIGITAL OPTICAL CD IN: Optical
DIGITAL OPTICAL AUX IN: Optical
Output
DIGITAL OPTICAL OUT: Optical

General

Dimensions (w/h/d) incl. projecting parts and controls
Approx. 202 × 101 × 298 mm
Mass Approx. 1.7 kg
Supplied accessories System cable (1)
Digital cable (1)

Design and specifications are subject to change
without notice.

MINIDISC DECK

9-929-537-12
2001F0200-1
© 2001.6

Sony Corporation
Home Audio Company
Shinagawa Tec Service Manual Production Group

SONY®

SELF-DIAGNOSIS FUNCTION

The self-diagnosis function consists of error codes for customers which are displayed automatically when errors occur, and error codes which show the error history in the test mode during servicing. For details on how to view error codes for the customer, refer to the following box in the instruction manual. For details on how to check error codes during servicing, refer to the following “Procedure for using the Self-Diagnosis Function (Error History Display Mode)”.

Self-diagnosis Display

This system has a Self-diagnosis display function to let you know if there is a system malfunction. The display shows a code made up of three letters and a message alternately to show you the problem. To solve the problem refer to the following list. If any problem persists, consult your nearest Sony dealer.

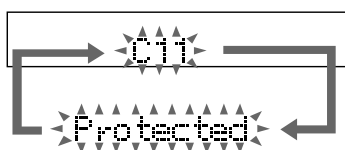

C11/Protected

The MD is protected against erasure.

→Remove the MD and slide the tab to close the slot (See page 11).

C12/Cannot Copy

You tried to record a CD or MD with a format that the system does not support, such as a CD-ROM.

→Remove the disc and turn off the system once, then turn it on again.

C13/REC Error

Recording could not be performed properly.

→Move the system to a stable place, and start recording over from the beginning.

The MD is dirty or scratched, or the MD does not meet the standards.

→Replace the MD and start recording over from the beginning.

C13/Read Error

The MD deck cannot read the disc information properly.

→Remove the MD once, then insert it again.

C14/Toc Error

The MD deck cannot read the disc information properly.

→Replace the MD.

→Erase all the recorded contents of the MD using the All Erase function (See page 32).

C41/Cannot Copy

The sound source is a copy of a commercially available music software, or you tried to record a CD-R (Recordable CD).

→The Serial Copy Management System prevents making a digital copy.

You cannot record a CD-R (see page 43).

C71/Check OPT-IN

This appears momentarily because of the signal of the digital broadcast during recording.

→There is no affect on the recorded contents.

No component is connected to the DIGITAL OPTICAL IN jack, or a digital component is not connected properly.

→Connect a digital component to the DIGITAL OPTICAL IN jack properly using a digital connecting cable (an optical cable) (not supplied (See page 39)).

The connected digital component is not turned on.

→See the operating instructions supplied with the connected component and confirm whether the component is turned on.

The digital connecting cable (an optical cable) connected to the DIGITAL OPTICAL IN jack is pulled out, or the connected digital component is turned off during digital recording.

→Connect the cable, or turn on the digital component.

Procedure for using the Self-Diagnosis Function (Error History Display Mode).

Note: Perform the self-diagnosis function in the “error history display mode” in the test mode. The following describes the least required procedure. Be careful not to enter other modes by mistake. If you set other modes accidentally, press the **MENU/NO** button (MD) to exit the mode.

1. When the power OFF (STANDBY), press the **I/⏻** button (TA) while pressing the **□** button (MD) and **ENTER/YES** button (MD) together.
2. Press the **MENU/NO** button, and when “Check” is displayed.
3. Rotate the **◀▶** knob (MD) and when “[Service]” is displayed, press the **ENTER/YES** button (MD).
4. Rotate the **◀▶** knob (MD) and display “ERR DP MODE”.
5. Pressing the **ENTER/YES** button (MD) sets the error history mode and displays “total rec”.
6. Select the contents to be displayed or executed using the **◀▶** knob (MD).
7. Pressing the **CD SYNC REC** button (MD) and to execute the contents selected.
8. Pressing the **CD SYNC REC** button (MD) another time returns to step 5.
9. Pressing the **MENU/NO** button (MD) displays “ERROR DP MODE” and exits the error history mode.
10. To exit the test mode, press the **I/⏻** button (TA). The unit sets into the STANDBY state, the disc is ejected, and the test mode ends.

ITEMS OF ERROR HISTORY MODE ITEMS AND CONTENTS

Selecting the Test Mode





Display	Details of History
total rec	Displays the recording time. Displayed as “r□□□□□h”. The displayed time is the total time the laser is set to the high power state. This is about 1/4 of the actual recording time. The time is displayed in decimal digits from 0h to 65535h.
total play	Displays the play time. Displayed as “p□□□□□h”. The time displayed is the total actual play time. Pauses are not counted. The time is displayed in decimal digits from 0h to 65535h.
retry err	Displays the total number of retries during recording and number of retry errors during play. Displayed as “r□□ p□□”. “r” indicates the retries during recording while “p” indicates the retry errors during play. The number of retries and retry errors are displayed in hexadecimal digits from 00 to FF.
total err	Displays the total number of errors. Displayed as “total □□”. The number of errors is displayed in hexadecimal digits from 00 to FF.
err history	Displays the 10 latest errors. Displayed as “0□ E@@”. □ indicates the history number. The smaller the number, the more recent is the error. (00 is the latest). @@ indicates the error code. Refer to the following table for the details. The error history can be switched by rotating the  knob (MD).
er refresh	Mode which erases the “retry err”, “total err”, and “err history” histories. When returning the unit to the customer after completing repairs, perform this to erase the past error history. After pressing the  button (MD) when “er refresh” appears, press  button (MD) to erase the history. “Complete!!” will be displayed momentarily. Be sure to check the following when this mode has been executed. <ul style="list-style-type: none"> • The data has been erased. • The mechanism operates normally when recording and play are performed.
tm refresh?	Mode which erases the “total rec” and “total play” histories. These histories serve as approximate indications of when to replace the optical pick-up. If the optical pick-up has been replaced, perform this operation and erase the history. After pressing the  button (MD) when “tm refresh?” is displayed, press the  button (MD) to erase the history. “Complete!!” will be displayed momentarily. Be sure to check the following when this mode has been executed. <ul style="list-style-type: none"> • The data has been erased. • The mechanism operates normally when recording and play are performed.

Table of Error Codes

Error Code	Details of Error	Error Code	Details of Error
E00	No error	E05	FOK has deviated
E01	Read error. PTOC cannot be read (DISC ejected)	E06	Cannot focus (Servo has deviated)
		E07	Recording retry
E02	TOC error. UTOC error (DISC not ejected)	E08	Recording retry error
		E09	Playback retry error
E03	Loading error		
E04	Address cannot be read (Servo has deviated)	E0A	Play retry error (C2 error)

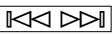
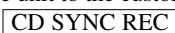
CAUTION

Danger of explosion if battery is incorrectly replaced.
Replace only with the same or equivalent type recommended by the equipment manufacturer.
Discard used batteries according to manufacture's instructions.

ADVARSEL!

Lithiumbatteri - Eksplosionsfare ved fejlagtig håndtering.
Udskiftning må kun ske med batteri af samme fabrikat og type.
Levér det brugte batteri tilbage til leverandøren.

ADVARSEL

Eksplosjonsfare ved feilaktig skifte av batteri.
Benytt samme batteritype eller en tilsvarende type anbefalt av apparatfabrikanten.
Brukte batterier katterier kasseres i henhold til fabrikantens

VARNIG

Explosionsfara vid felaktigt batteribyte.
Använd samma batterityp eller en likvärdig typ som rekommenderas av apparattillverkaren.
Kassera använt batteri enligt gällande föreskrifter.

VAROITUS

Parist voi räjähtää, jos se on virheellisesti asennettu.
Vaihda paristo ainoastaan laitevalmistajan suosittelemaan tyyppiin.
Hävitätä käytetty paristo valmistajan ohjeiden mukaisesti.

Laser component in this product is capable of emitting radiation exceeding the limit for Class 1.

CLASS 1 LASER PRODUCT
LUOKAN 1 LASERLAITE
KLASS 1 LASERAPPARAT

This appliance is classified as a CLASS 1 LASER product. The CLASS 1 LASER PRODUCT MARKING is located on the rear exterior.

CAUTION : INVISIBLE LASER RADIATION WHEN OPEN AND INTERLOCKS DEFEATED. AVOID EXPOSURE TO BEAM.
ADVARSEL : USYNLIG LASERSTRÅLING VED ÅBNING NÅR SIKKERHEDSAFBRYDERE ER UDE AF FUNKTION. UNDGÅ UDSÆTTELSE FOR STRÅLING.
VORSICHT : UNSICHTBARE LASERSTRAHLUNG. WENN ABDECKUNG GEÖFFNET UND SICHERHEITSVERRIEGELUNG ÜBERBRÜCKT. NICHT DEM STRAHL AUSSETZEN.
VARO! : AVATTAESSA JA SUOJALUKITUS OHITETTAESSA OLET ALT-TIINA NÄKYMÄTTÖMÄLLE LASERÄTEILYLLE. ÄLÄ KATSO SÄTEESEEN.
VARNING : OSYNLIG LASERSTRÅLING NÅR DENNA DEL ÄR ÖPPNAD OCH SPÄRREN ÄR URKOPPLAD. BETRAKTA EJ STRÅLEN.
ADVERSEL : USYNLIG LASERSTRÅLING NÅR DEKSEL ÅPNES OG SIKKERHEDSLÅS BRYTES. UNNGÅ EKSPONERING FOR STRÅLEN.
VIGYAZAT! : A BURKOLAT NYITÁSAKOR LÁTHATATLAN LÉZERSUGÁRVESZÉLY! KERÜLJE A BESUGÁRZÁST!

This caution label is located inside the unit.

CAUTION

Use of controls or adjustments or performance of procedures other than those specified herein may result in hazardous radiation exposure.

Notes on chip component replacement

- Never reuse a disconnected chip component.
- Notice that the minus side of a tantalum capacitor may be damaged by heat.

Flexible Circuit Board Repairing

- Keep the temperature of soldering iron around 270°C during repairing.
- Do not touch the soldering iron on the same conductor of the circuit board (within 3 times).
- Be careful not to apply force on the conductor when soldering or unsoldering.

SAFETY-RELATED COMPONENT WARNING !!

COMPONENTS IDENTIFIED BY MARK \triangle OR DOTTED LINE WITH MARK \triangle ON THE SCHEMATIC DIAGRAMS AND IN THE PARTS LIST ARE CRITICAL TO SAFE OPERATION. REPLACE THESE COMPONENTS WITH SONY PARTS WHOSE PART NUMBERS APPEAR AS SHOWN IN THIS MANUAL OR IN SUPPLEMENTS PUBLISHED BY SONY.

TABLE OF CONTENTS

1. SERVICING NOTE	6
2. GENERAL	13
3. DISASSEMBLY	
3-1. Case	14
3-2. Front Panel Assy	14
3-3. MD Mechanism Deck (MDM-5A)	15
3-4. Main Board	15
3-5. Slider (Cam)	16
3-6. BD Board	16
3-7. Over Write Head	17
3-8. Optical Pick-up (KMS-260A/J1N)	17
3-9. Spindle Motor, Sled Motor	17
4. TEST MODE	18
5. ELECTRICAL ADJUSTMENTS	22
6. DIAGRAMS	
6-1. Block Diagrams	
• BD Section	32
• Main Section	33
6-2. Printed Wiring Board – BD Section –	34
6-3. Schematic Diagram – BD (1/2) Section –	35
6-4. Schematic Diagram – BD (2/2) Section –	36
6-5. Schematic Diagram – Main (1/2) Section –	37
6-6. Schematic Diagram – Main (2/2) Section –	38
6-7. Printed Wiring Board – Main Section –	39
6-8. Printed Wiring Board – Panel Section –	40
6-9. Schematic Diagram – Panel Section –	41
6-10. Schematic Diagram – BD Switch Section –	42
6-11. Printed Wiring Board – BD Switch Section –	42
6-12. IC Block Diagrams	42
6-13. IC Pin Functions	45
7. EXPLODED VIEWS	
7-1. Case and Front Panel Section	50
7-2. Mechanism Deck Section (MDM-5A)	51
7-3. Base Unit Section (MBU-5A)	52
8. ELECTRICAL PARTS LIST	53

MODEL IDENTIFICATION

— BACK PANEL —

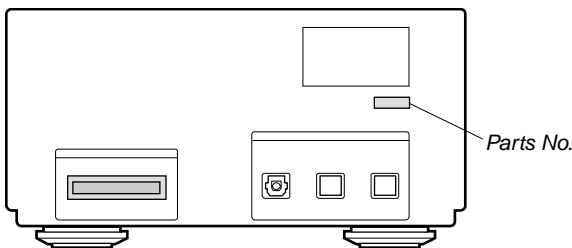

MODEL	PARTS No.
AEP, UK, AED models	4-229-665-0□
HK, MY, SP models	4-229-665-2□
KR model	4-229-665-3□

- Abbreviation
- AED : North European model
- MY : Malaysia model
- SP : Singapore model
- HK : Hong kong model
- KR : Korea model

SECTION 1

SERVICING NOTE

This unit cannot be repaired by itself.

When repairing, connect the whole system except for the speaker.

CD Text Display

- This unit displays CD text.



Text is displayed for the first 50 track only and will not be displayed from the 51st track onwards. Do not suspect a fault in this case.

In some cases, some special characters will not be displayed and may be replaced by other characters. Do not suspect a fault in this case.

Cold Reset

- The cold reset clears all data including preset data stored in the RAM to initial conditions. Execute this mode when returning the set to the customer.



Procedure :

1. When the power ON, press the  button (TA) while pressing the  button (ST) and  buttons (CD) together.
2. "COLD RESET" is displayed on the fluorescent indicator tube and reset is executed.

Hot Reset









- This mode reset the preset data kept in the memory. The hot reset mode functions same as if the power cord is plugged in and out.

Procedure :

1. When the power ON, press the  button (TA) while pressing the  button (ST) and  buttons (CD) together.
2. Turn off the unit and reset is executed.

GC Test Mode

Procedure :

1. When the power ON, press the  button (TA) while pressing the  button (ST) and  buttons (CD) together.
2. LCD are all turned on.
3. Press  button (ST) to enter the model destination indication mode. "SP55 CE2" or "SP55 ASIA2" appears.
4. Every pressing of  button (ST) changes the display in the following order.
MC Version → CD Version → ST Version → TC Version → TA Version → TM Version → model destination display.
5. Press  button (ST) and the date appears as "00615a"
Every pressing of  button (ST) changes the display in the Version display and model destination display.
6. Press  button (ST) to enter the key check mode.
7. In the key check mode, the fluorescent indicator tube displays "Key 0 Vol 0". Each time a button is pressed, "Key" value increases. However, once a button is pressed, it is no longer taken into account.
"Vol" Value increases like "1, 2, 3 ..." if rotating  knob (TA) in the clockwise direction, or decreases like "0, 9, 8 ..." if rotating in the counterclockwise direction.
8. To exit from this mode, disconnect the power cord.

JIG FOR CHECKING BD BOARD WAVEFORM

The special jig (J-2501-149-A) is useful for checking the waveform of the BD board. The names of terminals and the checking items to be performed are shown as follows.

GND : Ground

I+3V : For measuring IOP (Check the deterioration of the optical pick-up laser)

IOP : For measuring IOP (Check the deterioration of the optical pick-up laser)

TEO : TRK error signal (Traverse adjustment)

VC : Reference level for checking the signal



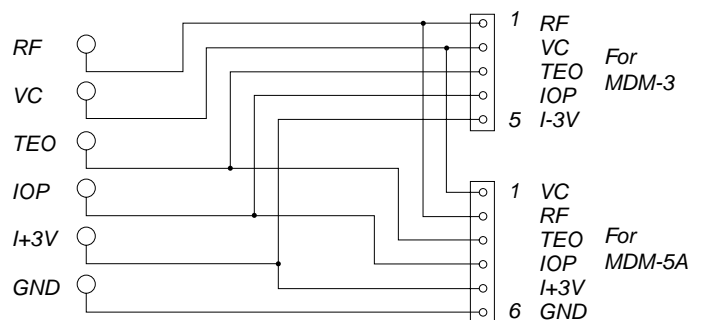
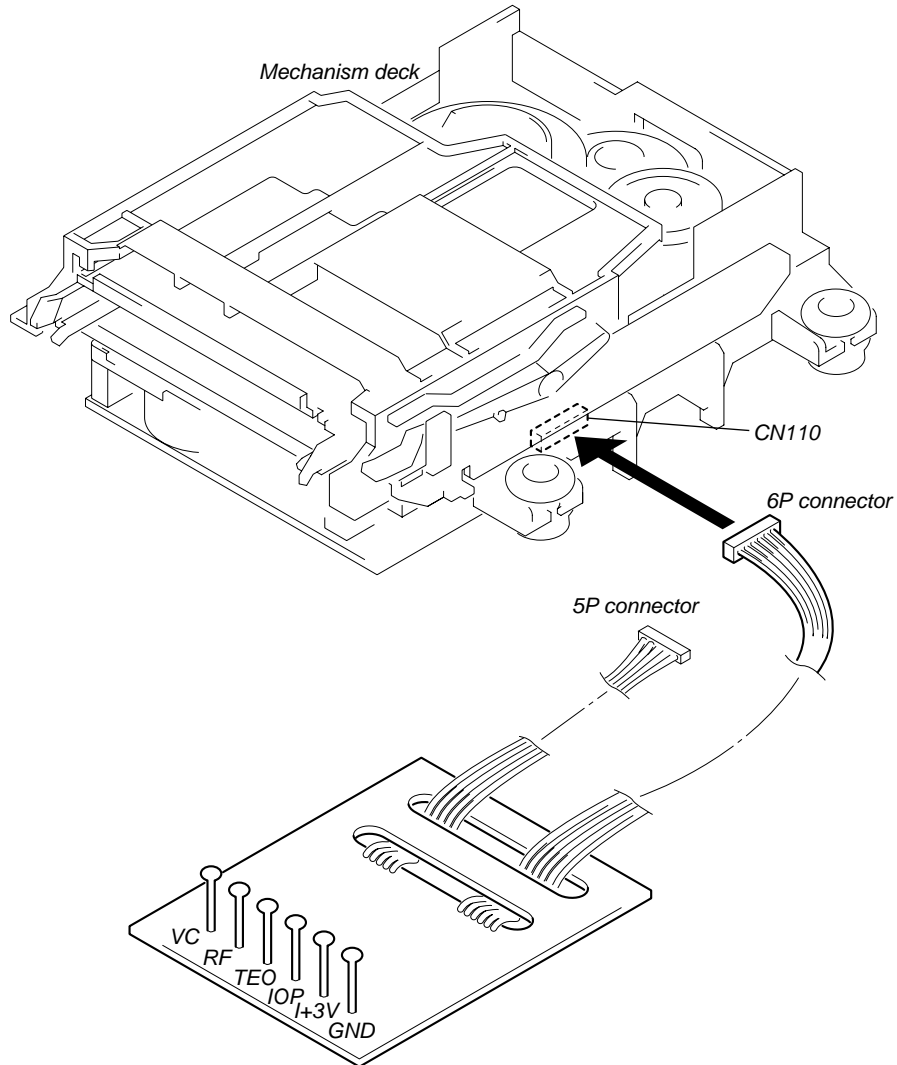









RF : RF signal (Check jitter)







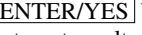



IOP DATA RECORDING AND DISPLAY WHEN OPTICAL PICK-UP AND NON-VOLATILE MEMORY (IC171 OF BD BOARD) ARE REPLACED

The IOP value labeled on the optical pick-up can be recorded in the non-volatile memory. By recording the value, it will eliminate the need to look at the value on the label of the optical pick-up. When replacing the optical pick-up or non-volatile memory (IC171 of BD board), record the IOP value on the optical pick-up according to the following procedure.

Record Procedure:

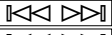
1. When the power OFF (STANDBY), press the  button (TA) while pressing the  button (MD) and  button (MD) together.
2. Press the  button (MD), and when “Check” is displayed.
3. Rotate the  knob (MD) to display “MD [Service]”, and press the  button (MD).
4. Rotate the  knob (MD) to display “MD Iop Write”, and press the  button (MD).
5. The display becomes “MD Ref=@@.@” (@ is an arbitrary number) and the numbers which can be changed will blink.
6. Input the IOP value written on the optical pick-up.
To select the number : Press the  button (MD), and when “Check” is displayed.
To select the digit : Press the  button (MD).
7. When the  button (MD) is pressed, the display becomes “MD Measu=@@.@” (@ is an arbitrary number).
8. As the adjustment results are recorded for the 6 value. Leave it as it is and press the  button (MD).
9. “MD Complete!” will be displayed momentarily. The value will be recorded in the non-volatile memory and the display will become “MD Iop Write”.
10. Press the  button (TA) to complete.

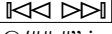
Display Procedure:

1. When the power OFF (STANDBY), press the  button (TA) while pressing the  button (MD) and  button (MD) together.
2. Press the  button (MD), and when “Check” is displayed.
3. Rotate the  knob (MD) to display “MD [Service]”, and press the  button (MD).
4. Rotate the  knob (MD) to display “MD Iop Read”.
5. “MD @@.@/###.#” is displayed and the recorded contents are displayed.
@@.@ : indicates the Iop value labeled on the pick-up.
###.# : indicates the Iop value after adjustment
6. To end, press the  button (MD) to display “MD Iop Read”. Then press the  button (TA).

CHECKS PRIOR TO PARTS REPLACEMENT AND ADJUSTMENTS

Before performing repairs, perform the following checks to determine the faulty locations up to a certain extent. Details of the procedures are described in “5 Electrical Adjustments”.

	Criteria for Determination (Unsatisfactory if specified value is not satisfied)	Measure if unsatisfactory:
Laser power check (5-6-2 : See page 24)	<ul style="list-style-type: none"> 0.9 mW power Specified value : 0.84 to 0.92 mW 7.0 mW power Specified value : 6.8 to 7.2 mW 	<ul style="list-style-type: none"> Clean the optical pick-up Adjust again Replace the optical pick-up
	<ul style="list-style-type: none"> Iop (at 7mW) Labeled on the optical pick-up Iop value \pm 10mA 	<ul style="list-style-type: none"> Replace the optical pick-up
Traverse check (5-6-3 : See page 24)	<ul style="list-style-type: none"> Traverse waveform Specified value : Below 10% offset 	<ul style="list-style-type: none"> Replace the optical pick-up
Focus bias check (5-6-4 : See page 25)	<ul style="list-style-type: none"> Error rate check Specified value : For points a, b, and c C1 error : Below 220 AD error : Below 2 	<ul style="list-style-type: none"> Replace the optical pick-up
C PLAY check (5-6-5 : See page 25)	<ul style="list-style-type: none"> Error rate check Specified value: a. When using test disc (MDW-74/GA-1) C1 error : Below 80 AD error : Below 2 b. When using check disc (TDYS-1) C1 error : Below 50 	<ul style="list-style-type: none"> Replace the optical pick-up
Self-recording/playback check (REC/PLAY) (5-6-6 : See page 25)	<ul style="list-style-type: none"> CPLAY error rate check Specified value: C1 error : Below 80 AD error : Below 2 	If always unsatisfactory: <ul style="list-style-type: none"> Replace the overwrite head Check for disconnection of the circuits around the overwrite head
		If occasionally unsatisfactory: <ul style="list-style-type: none"> Check if the overwrite head is distorted Check the mechanism around the sled
TEMP check (Temperature compensation offset check) (5-6-1 : See page 24)	<ul style="list-style-type: none"> Unsatisfactory if displayed as T=@@ (##) [NG] NG (@@, ## are both arbitrary numbers) 	<ul style="list-style-type: none"> Check for disconnection of the circuits around D101 (BD board) Check the signals around IC101, IC121, CN102, CN103 (BD board)

Note:

The criteria for determination above is intended merely to determine if satisfactory or not, and does not serve as the specified value for adjustments.

When performing adjustments, use the specified values for adjustments.

FORCED RESET

The system microprocessor can be reset in the following procedure.

Use these procedure when the unit cannot be operated normally due to the overrunning of the microprocessor, etc.

Procedure :

Remove the short-pin attached to CN821, and power off or del AC cable, and then attach it again. Remove the AC code, and wait for about five seconds, and turn on the power again, and put the short-pin.

[MAIN BOARD] (Component Side)

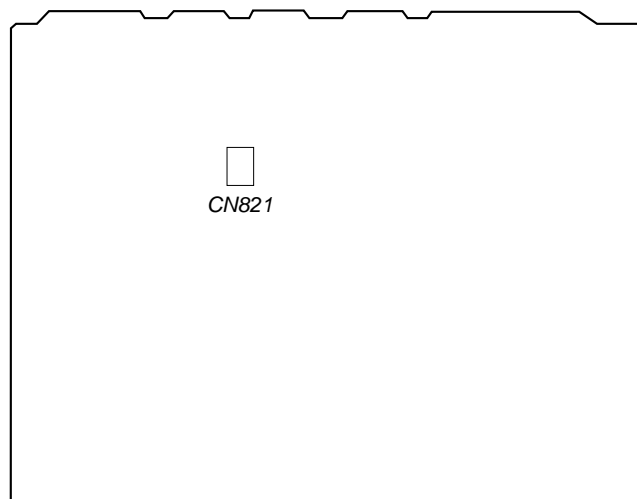

RETRY CAUSE DISPLAY MODE

- In this test mode, the causes for retry of the unit during recording can be displayed on the fluorescent indicator tube. During playback, the “track mode” for obtaining track information will be set. This is useful for locating the faulty part of the unit.
- The following will be displayed :
 - During recording and stop : Retry cause, number of retries, and number of retry errors.
 - During playback : Information such as type of disc played, part played, copyright.
 These are displayed in hexadecimal.

Procedure:

- Load a recordable disc whose contents can be erased, into the unit.
- Press the **MENU/NO** button (MD). When “Edit/Menu” is displayed on the LCD display, Rotate the **◀▶** knob (MD) to display “All Erase??”.
- Press the **ENTER/YES** button (MD).
- “All Erase??” is displayed on the LCD display.
- Press the **ENTER/YES** button (MD) to display “Complete!!”, and press the **□** button (MD) immediately. Wait for about 10 seconds while pressing the button.
- When the “MD Blank disk” displayed on the LCD display goes off, release the **□** button (MD).
- Press the **●REC** button (MD) to enter recording standby. Then press the **□** button (MD) and start recording. In about 2 seconds, the record mode retry cause is displayed. (Fig.1) If recording cannot be performed, rotate the **FUNCTION** knob (TA) and set a different section.
- To check the “track mode”, stop recording by pressing **□** button (MD) and press the **▶** button (MD) to start play and the track information in the play mode appears.
- To exit the test mode, press the **I/O** button (TA), and turn OFF the power. When “STNDBY” disappears, disconnect the power plug from the outlet. If the test mode cannot be exited, refer to “Forced Reset” on page 9.

Fig. 1 Reading the Test Mode Display (During recording and stop)

RTs@@c##c**
Fluorescent display tube display

@@ : Cause of retry
: Number of retries
** : Number of retry errors

Reading the Retry Cause Display

Hexadecimal	Higher Bits				Lower Bits				Hexa-decimal	Cause of Retry	Occurring conditions
	8	4	2	1	8	4	2	1			
Bit	b7	b6	b5	b4	b3	b2	b1	b0			
Binary	0	0	0	0	0	0	0	1	01	shock	When track jump (shock) is detected
	0	0	0	0	0	0	1	0	02	ader5	When ADER was counted more than five times continuously
	0	0	0	0	0	1	0	0	04	Discontinuous address	When ADIP address is not continuous
	0	0	0	0	1	0	0	0	08	DIN unlock	When DIN unlock is detected
	0	0	0	1	0	0	0	0	10	FCS incorrect	When not in focus
	0	0	1	0	0	0	0	0	20	IVR rec error	When ABCD signal level exceeds the specified range
	0	1	0	0	0	0	0	0	40	CLV unlock	When CLV is unlocked
	1	0	0	0	0	0	0	0	80	Access fault	When access operation is not performed normally

Reading the Display:

Convert the hexadecimal display into binary display. If more than two causes, they will be added.

Example

When 42 is displayed:

Higher bit : 4 = 0100 → b6

Lower bit : 2 = 0010 → b1

In this case, the retry cause is combined of “CLV unlock” and “ader5”.

When A2 is displayed:

Higher bit : A = 1010 → b7+b5

Lower bit : 2 = 0010 → b1

The retry cause in this case is combined of “Access fault”, “IVR rec error”, and “ader5”.

Reading the Track Mode Display

Hexadecimal	Higher Bits				Lower Bits				Hexadecimal	Details	
	8	4	2	1	8	4	2	1		When 0	When 1
Bit	b7	b6	b5	b4	b3	b2	b1	b0			
Binary	0	0	0	0	0	0	0	1	01	Emphasis OFF	Emphasis ON
	0	0	0	0	0	0	1	0	02	Monaural	Stereo
	0	0	0	0	0	1	0	0	04	This is 2-bit display. Normally 01. 01:Normal audio. Others:Invalid	
	0	0	0	0	1	0	0	0	08		
	0	0	0	1	0	0	0	0	10	Audio (Normal)	Invalid
	0	0	1	0	0	0	0	0	20	Original	Digital copy
	0	1	0	0	0	0	0	0	40	Copyright	No copyright
	1	0	0	0	0	0	0	0	80	Write prohibited	Write allowed

Reading the Display:

Convert the hexadecimal display into binary display. If more than two causes, they will be added.

Example When 84 is displayed:

Higher bit : 8 = 1000 → b7

Lower bit : 4 = 0100 → b2

In this case, as b2 and b7 are 1 and others are 0, it can be determined that the retry cause is combined of “Emphasis OFF”, “Monaural”, “Original”, “Copyright exists”, and “Write allowed”.

Example When 07 is displayed:

Higher bit : 0 = 1000 → All 0

Lower bit : 7 = 0111 → b0+b1+b2

In this case, as b0, b1, and b2 are 1 and others are 0, it can be determined that the retry cause is combined of “Emphasis ON”, “Stereo”, “Original”, “Copyright exists”, and “Write prohibited”.

Hexadecimal → Binary Conversion Table

Hexadecimal	Binary	Hexadecimal	Binary
0	0000	8	1000
1	0001	9	1001
2	0010	A	1010
3	0011	B	1011
4	0100	C	1100
5	0101	D	1101
6	0110	E	1110
7	0111	F	1111

SERVICING POSITION

1. Remove the four screws securing the upper case, and remove the upper case.
2. Remove the three screws **A** securing the rear panel.
3. Remove the two craw **B** securing the MAIN board.
4. Remove the MAIN board with the rear panel.

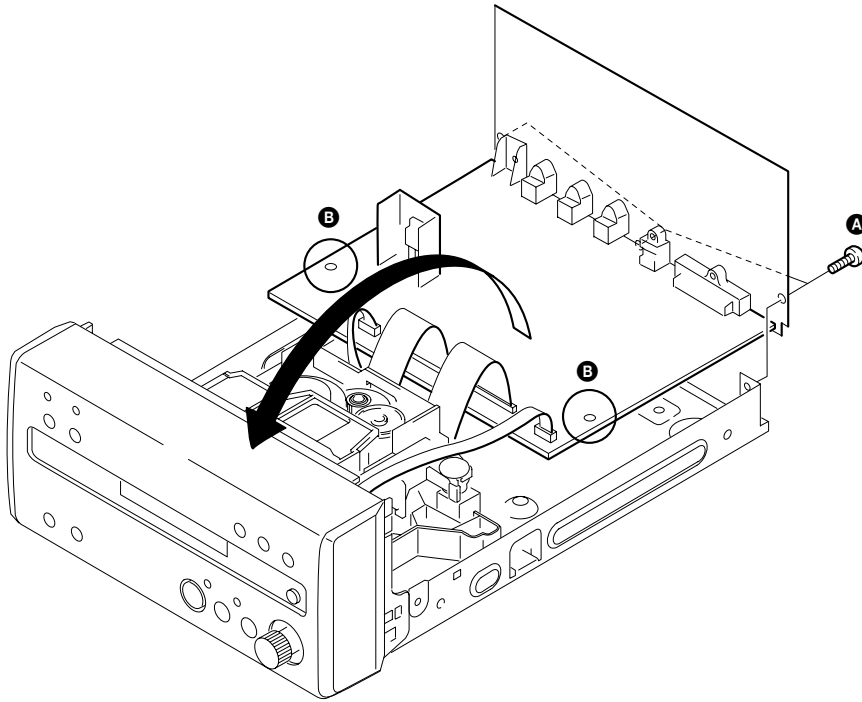

SECTION 2 GENERAL

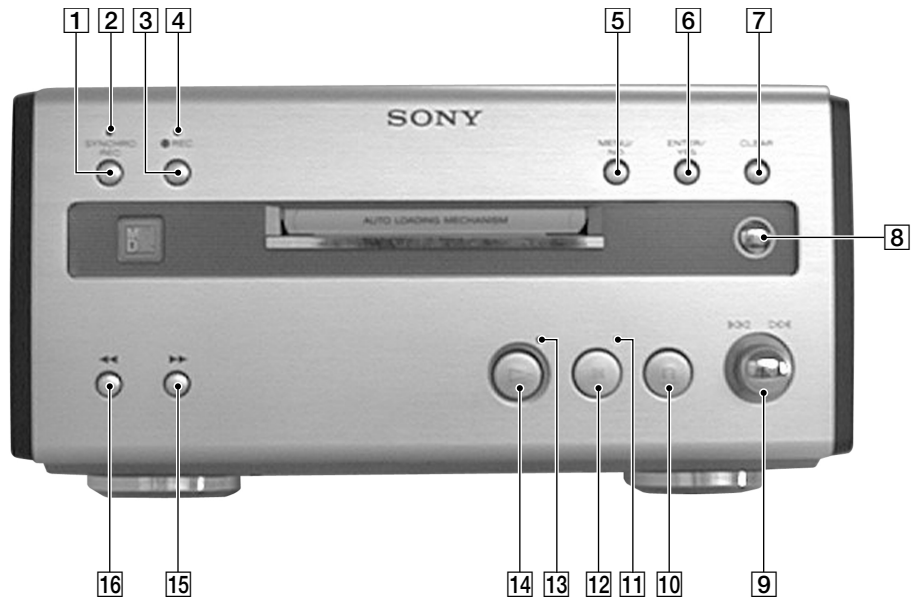

- | | | | |
|----------|-----------------------|-----------|-------------|
| 1 | CD SYNC REC button | 9 | ⏮ ⏭ knob |
| 2 | CD SYNC REC indicator | 10 | □ button |
| 3 | ● REC button | 11 | ⏪ indicator |
| 4 | ● REC indicator | 12 | ⏪ button |
| 5 | MENU/NO button | 13 | ▷ indicator |
| 6 | ENTER/YES button | 14 | ▷ button |
| 7 | CLEAR button | 15 | ⏩ button |
| 8 | ⏏ button | 16 | ⏮ button |

SECTION 3 DISASSEMBLY

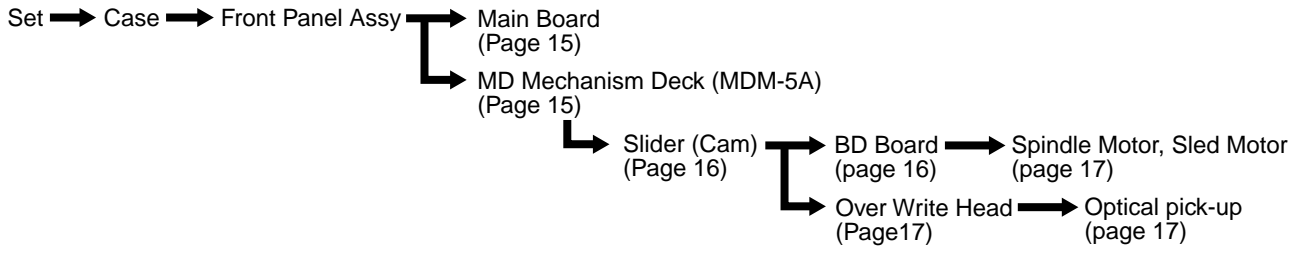

Note: Follow the disassembly procedure in the numerical order given.

3-1. CASE

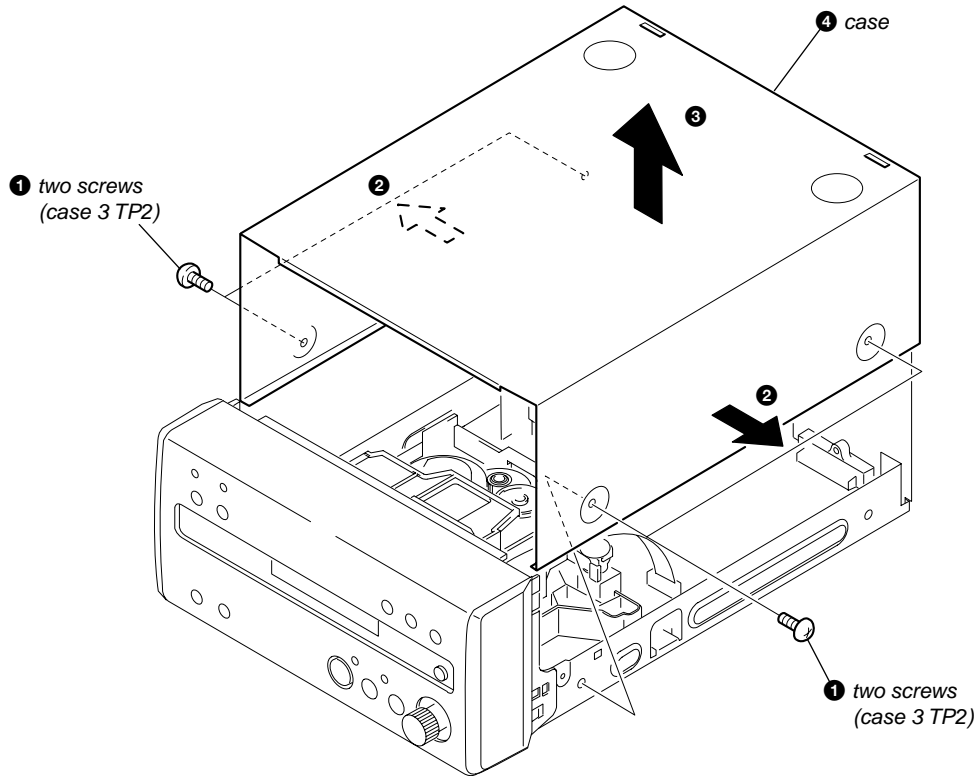

3-2. FRONT PANEL ASSY

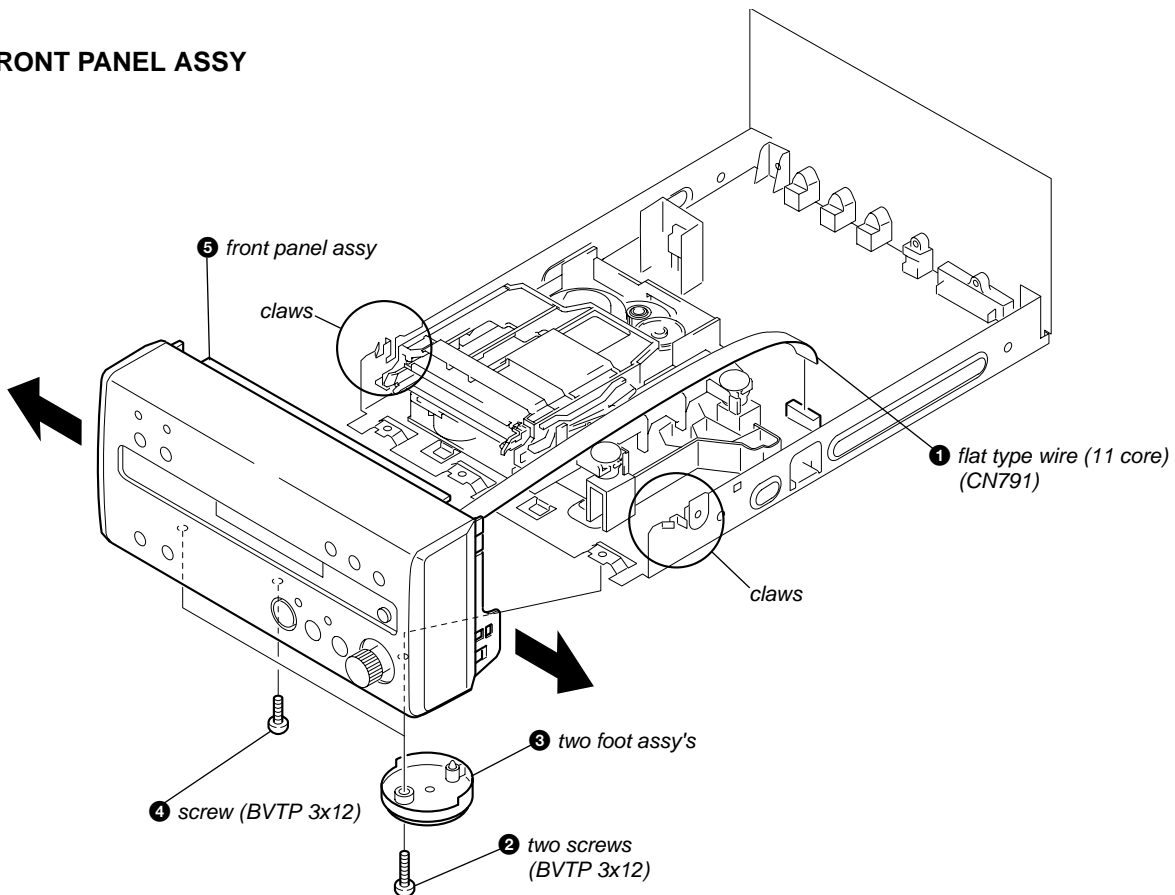

3-3. MD MECHANISM DECK (MDM-5A)

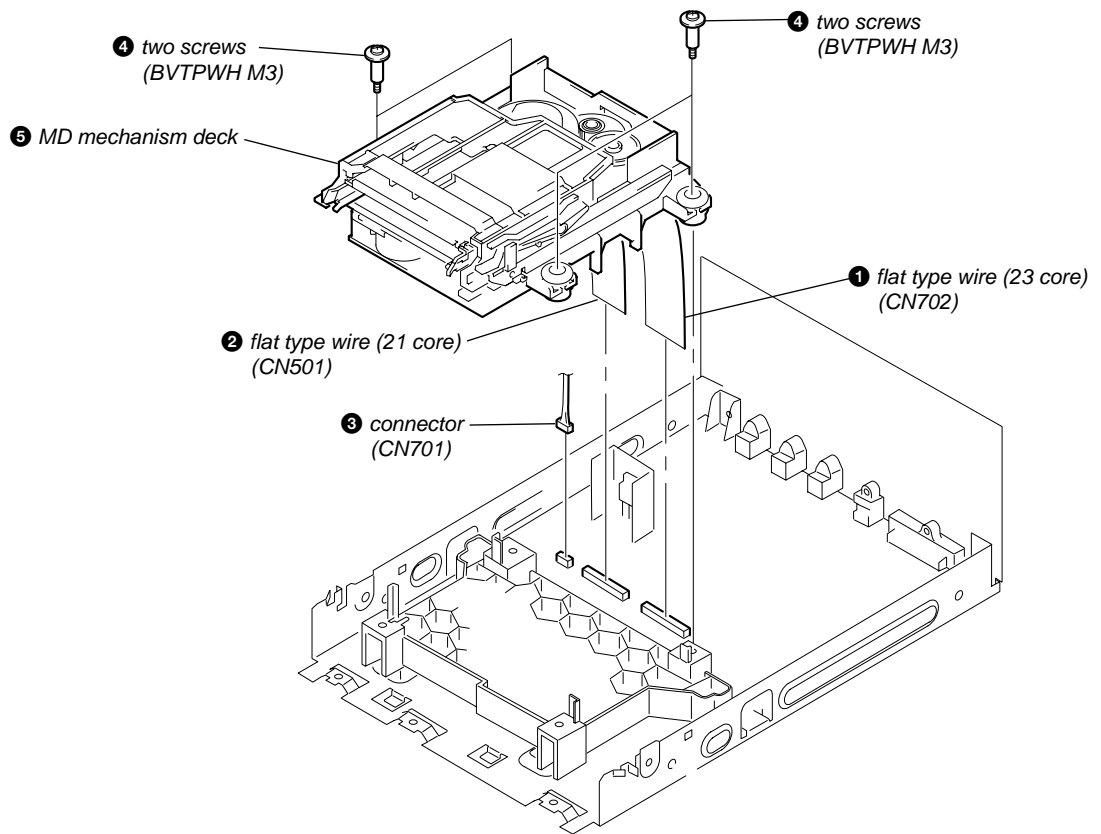

3-4. MAIN BOARD

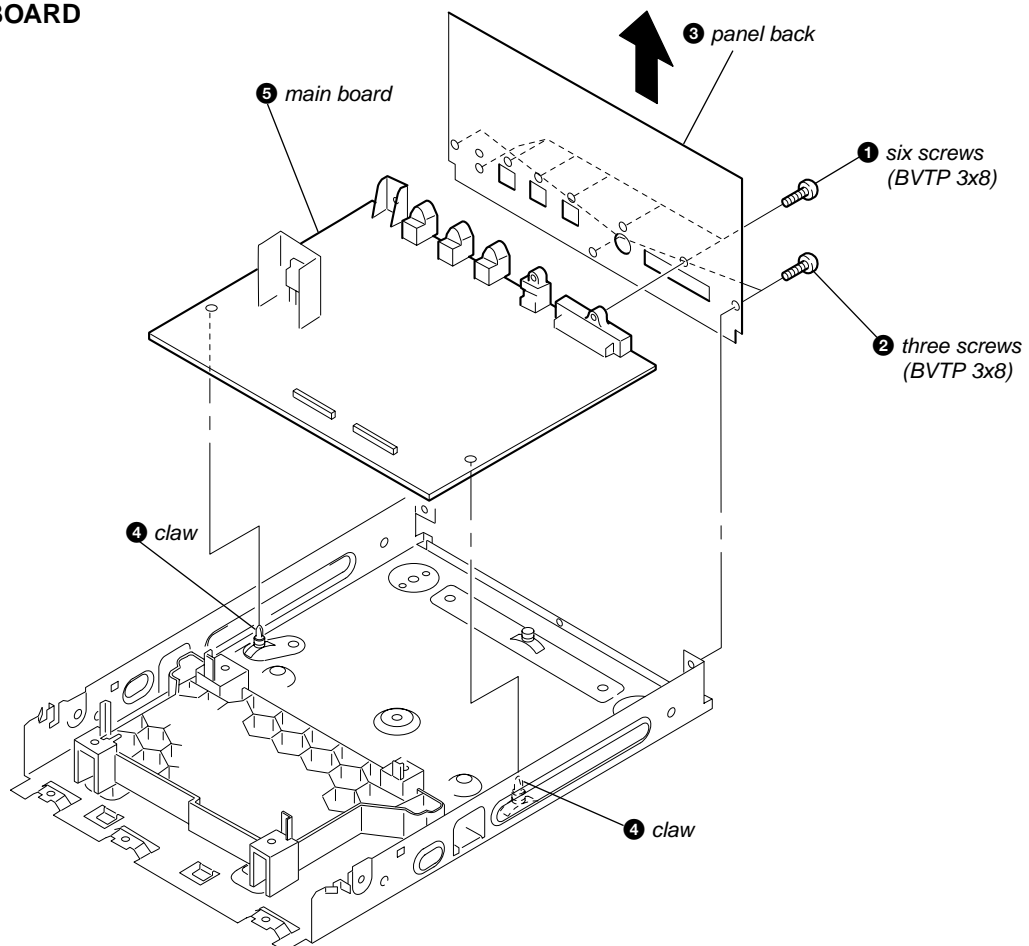

3-5. SLIDER (CAM)

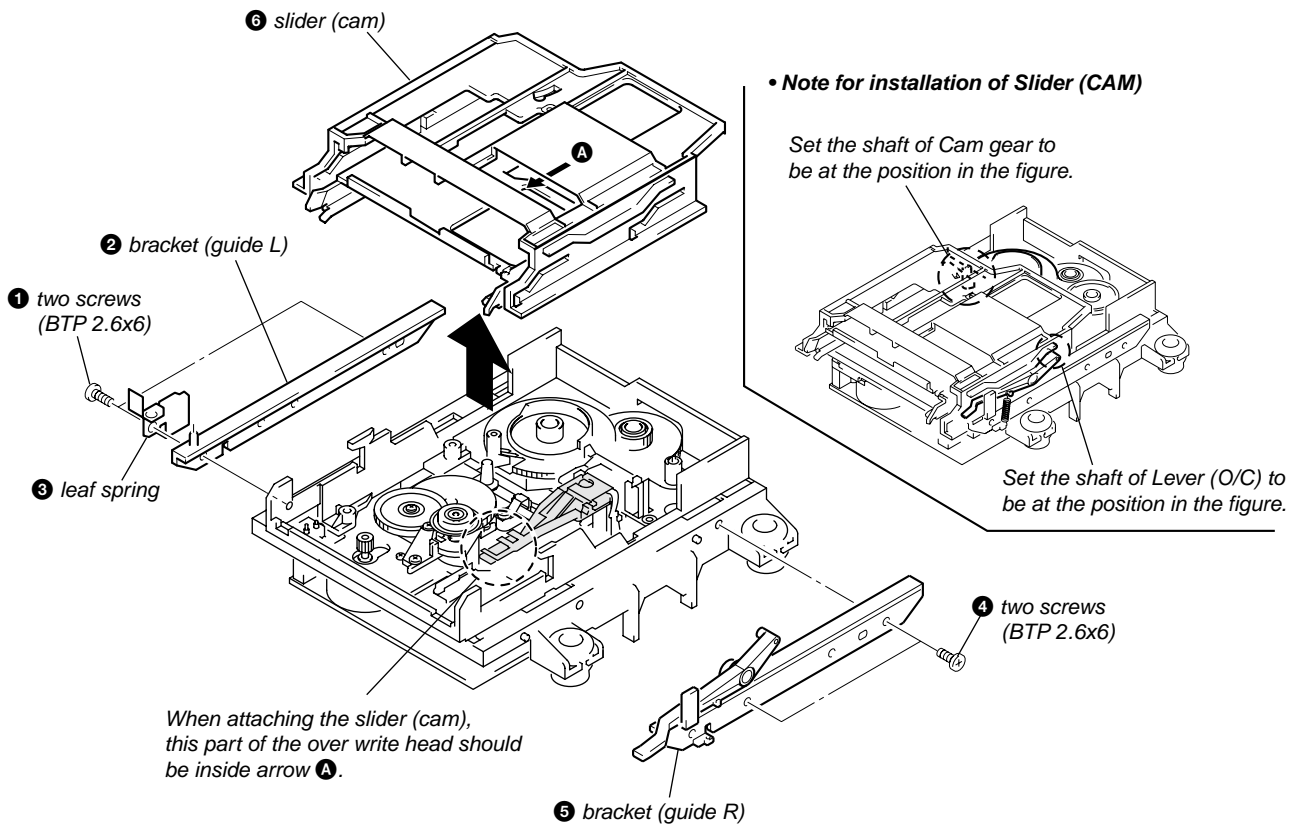

3-6. BD BOARD

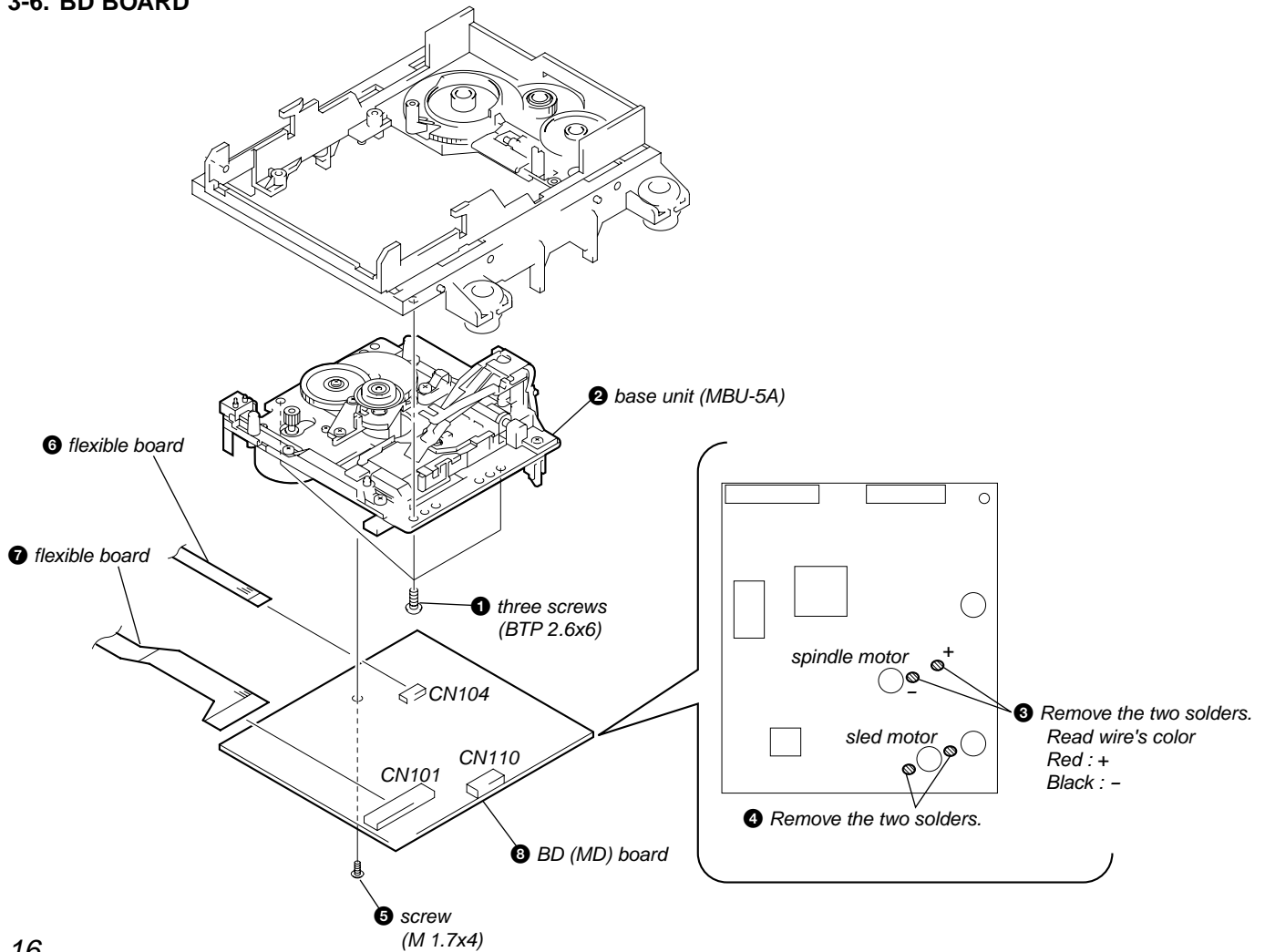

3-7. OVER WRITE HEAD

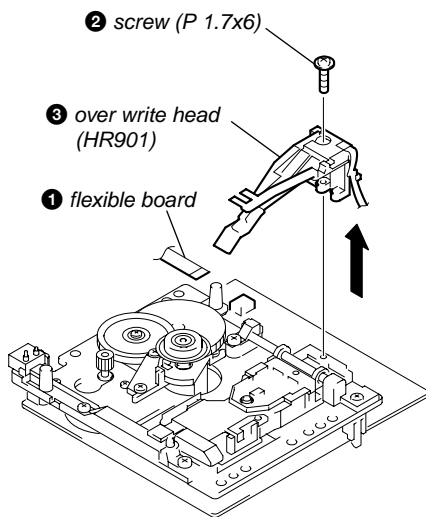

3-8. OPTICAL PICK-UP (KMS-260B/S1NP)

Note:

Turn the optical pick-up inside out, and pull out the flexible board.

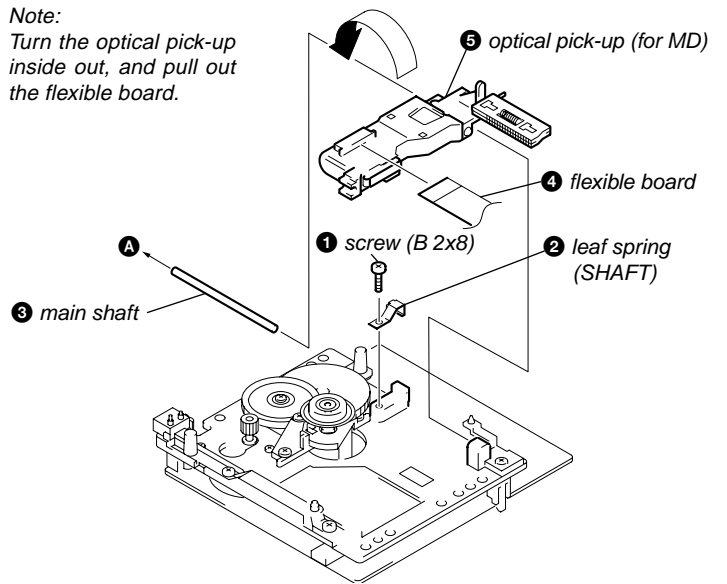

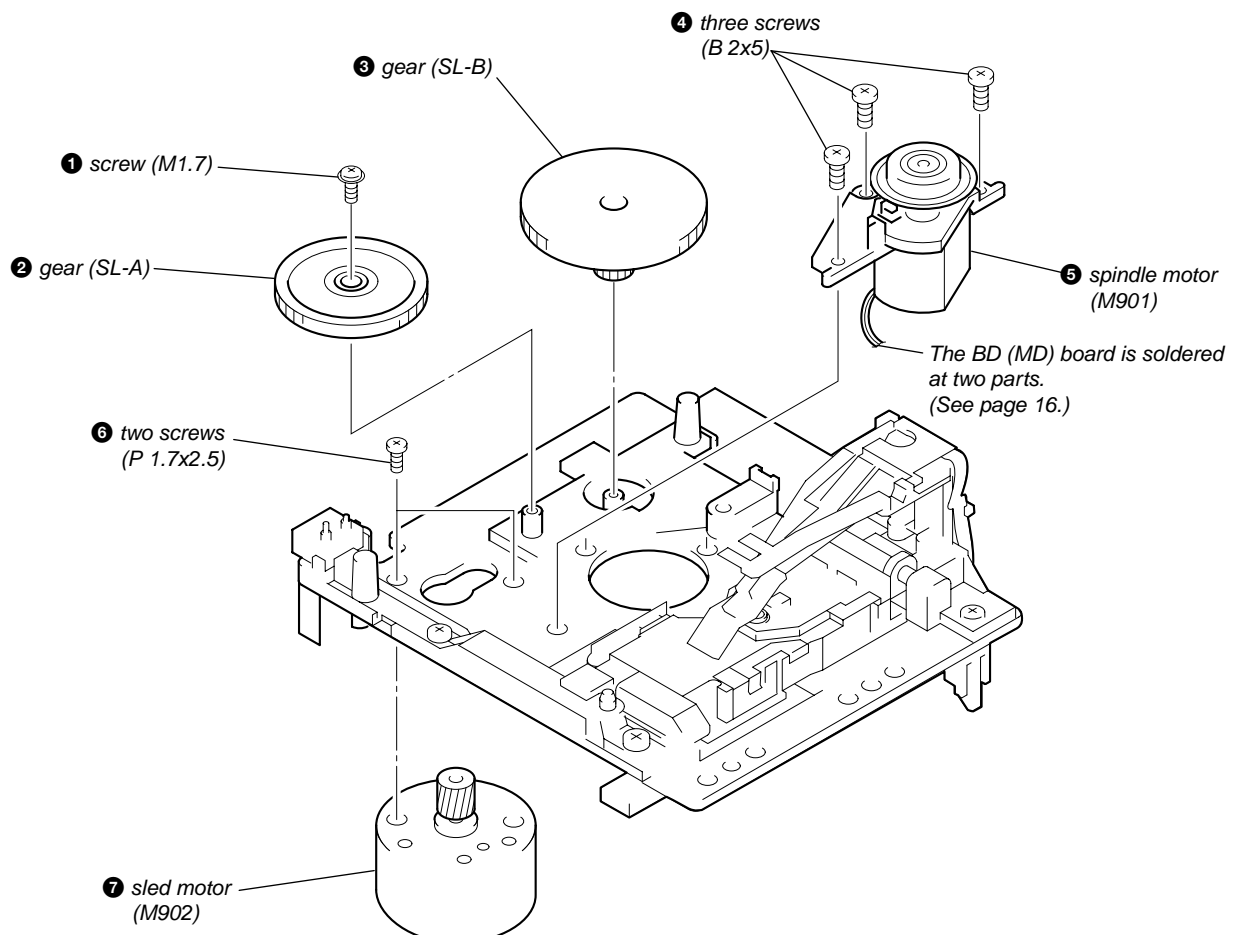

3-9. SPINDLE MOTOR, SLED MOTOR



SECTION 4 TEST MODE

4-1. PRECAUTIONS FOR USE OF TEST MODE







- As loading related operations will be performed regardless of the test mode operations being performed, be sure to check that the disc is stopped before setting and removing it.
Even if the  button (MD) is pressed while the disc is rotating during continuous playback, continuous recording, etc., the disc will not stop rotating.
Therefore, it will be ejected while rotating.
Be sure to press the  button (MD) after pressing the  button (MD) and the rotation of disc is stopped.

4-1-1. Recording laser emission mode and operating buttons

- Continuous recording mode (MD CREC MODE)
- Laser power check mode (MD LDPWR CHECK)
- Laser power adjustment mode (MD LDPWR ADJUST)
- Traverse (MO) check (MD EF MO CHECK)
- Traverse (MO) adjustment (MD EF MO ADJUST)
- When pressing the  button (MD).

4-2. SETTING THE TEST MODE



The following are two methods of entering the test mode.



- Rotate the  knob (TA), and set the function to “MD” before hand. When the power OFF (STANDBY), press the  button (TA) while pressing the  button (MD) and  button (MD) together.
- Press the  button (MD), and when “MD Check” is displayed.
- When the test mode is set, “MD [Check]” will be displayed. Rotate the  knob (MD) switches between the following four groups; ... \longleftrightarrow MD Check \longleftrightarrow MD Adjust \longleftrightarrow MD Service \longleftrightarrow MD Develop \longleftrightarrow

4-3. EXITING THE TEST MODE

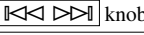

Press the  button (TA). The disc is ejected when loaded, and “Standby” display blinks, and the STANDBY state is set.

4-4. BASIC OPERATIONS OF THE TEST MODE

All operations are performed using the  knob (MD),  button (MD), and  button (MD).
The functions of these buttons are as follows.

Function name	Function
 knob (MD)	Changes parameters and modes
 button (MD)	Proceeds onto the next step. Finalizes input.
 button (MD)	Returns to previous step. Stops operations.

4-5. SELECTING THE TEST MODE

There are 31 types of test modes as shown below. The groups can be switched by rotating the  knob (MD). After selecting the group to be used, press the  button (MD). After setting a certain group, rotating the  knob (MD) switches between these modes.

Refer to “Group” in the table for details selected.

All items used for servicing can be treated using group S. So be carefully not to enter other groups by mistake.

Display	Contents	Mark	Group (*)
MD TEMP CHECK	Temperature compensation offset check		C S
MD LDPWR CHECK	Laser power check		C S
MD EF MO CHECK	Traverse (MO) check		C S
MD EF CD CHECK	Traverse (CD) check		C S
MD FBIAS CHECK	Focus bias check		C S
MD S curve CHECK	S letter check	(X)	C
MD VERIFY MODE	Non-volatile memory check	(X)	C
MD DETRK CHECK	Detrack check	(X)	C
MD TEMP ADJUST	Temperature compensation offset adjustment		A S
MD LDPWR ADJUST	Laser power adjustment		A S
MD EF MO ADJUST	Traverse (MO) adjustment		A S
MD EF CD ADJUST	Traverse (CD) adjustment		A S
MD FBIAS ADJUST	Focus bias adjustment		A S
MD EEP MODE	Non-volatile memory control	(X) (!)	D
MD MANUAL CMD	Command transmission	(X)	D
MD SVDATA READ	Status display	(X)	D
MD ERR DP MODE	Error history display, clear		S
MD SLED MOVE	Sled check	(X)	D
MD ACCESS MODE	Access check	(X)	D
MD 0920 CHECK	Outermost circumference check	(X)	D
MD HEAD ADJUST	Head position check	(X)	D
MD CPLAY2 MODE	Same functions as CPLAY MODE	(X)	D
MD CREC2 MODE	Same functions as CREC MODE	(X)	D
MD ADJ CLEAR	Initialization of non-volatile memory of adjustment value		A S
MD AG Set (MO)	Auto gain output level adjustment (MO)		A S
MD AG Set (CD)	Auto gain output level adjustment (CD)		A S
MD Iop Read	IOP data display		C S
MD Iop Write	IOP data write		A S
MD INFORMATION	Microprocessing version display		C S
MD CPLAY MODE	Continuous play mode		C A S D
MD CREC MODE	Continuous recording mode		C A S D

Group (*)

C: Check A: Adjust
S: Service D: Develop

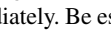
- For details of each adjustment mode, refer to “5. Electrical Adjustments”.
- For details of “ERR DP MODE”, refer to “Self-Diagnosis Function” on page 2.
- If a different mode has been selected by mistake, press the  button (MD) to exit that mode.
- Modes with (X) in the Mark column are not used for servicing and therefore are not described in detail. If these modes are set accidentally, press the  button (MD) to exit the mode immediately. Be especially careful not to set the modes with (!) as they will overwrite the non-volatile memory and reset it, and as a result, the unit will not operate normally.

4-5-1. Operating the Continuous Playback Mode

1. Entering the continuous playback mode

- ① Set the disc in the unit. (Whichever recordable discs or discs for playback only are available.)
- ② Rotate the [◀▶] knob (MD) and display “MD CPLAY MODE”.
- ③ Press the [ENTER/YES] button (MD) to change the display to “MD CPLAY MID”.
- ④ When access completes, the display changes to “MD C = [] AD = []”.

Note : The numbers “[]” displayed show you error rates and ADER.

2. Changing the parts to be played back

- ① Press the [ENTER/YES] button (MD) during continuous playback to change the display as below.

“MD CPLAY MID” → “MD CPLAY OUT” → “MD CPLAY IN”

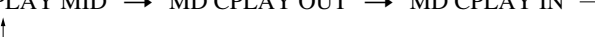

When pressed another time, the parts to be played back can be moved.

- ② When access completes, the display changes to “MD C = [] AD = []”.

Note : The numbers “[]” displayed show you error rates and ADER.

3. Ending the continuous playback mode

- ① Press the [MENU/NO] button (MD). The display will change to “MD CPLAY MODE”.
- ② Press the [] button (MD) to remove the disc.

Note : The playback start addresses for IN, MID, and OUT are as follows.

IN 40h cluster
MID 300h cluster
OUT 700h cluster

4-5-2. Operating the Continuous Recording Mode (Use only when performing self-recording/palyback check.)

1. Entering the continuous recording mode

- ① Set a recordable disc in the unit.
- ② Rotate the [◀▶] knob (MD) and display “MD CREC MODE”.
- ③ Press the [ENTER/YES] button (MD) to change the display to “MD CREC MID”.
- ④ When access completes, the display changes to “MD CREC ([])”.

Note : The numbers “[]” displayed shows you the recording position addresses.

2. Changing the parts to be recorded

- ① When the [ENTER/YES] button (MD) is pressed during continuous recording, the display changes as below.

“MD CPLAY MID” → “MD CPLAY OUT” → “MD CPLAY IN”

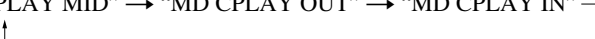

When pressed another time, the parts to be recorded can be changed.

- ② When access completes, the display changes to “MD CREC ([])”.

Note : The numbers “[]” displayed shows you the recording position addresses.

3. Ending the continuous recording mode

- ① Press the [MENU/NO] button (MD). The display changes to “MD CREC MODE”.
- ② Press the [] button (MD) to remove the disc.

Note 1 : The recording start addresses for IN, MID, and OUT are as follows.

IN 40h cluster
MID 300h cluster
OUT 700h cluster

Note 2 : The [MENU/NO] button (MD) can be used to stop recording anytime.

Note 3 : Do not perform continuous recording for long periods of time above 5 minutes.







Note 4 : During continuous recording, be careful not to apply vibration.

4-5-3. Non-Volatile Memory Mode (EEP MODE)

This mode reads and writes the contents of the non-volatile memory.

It is not used in servicing. If set accidentally, press the [MENU/NO] button (MD) immediately to exit it.

4-6. FUNCTIONS OF OTHER BUTTONS

Function	Contents
	Sets continuous playback state. playback, the tracking servo turns ON.
	Stops continuous playback and continuous recording.
	The sled moves to the outer circumference only when this is pressed.
	The sled moves to the inner circumference only when this is pressed.
	ON/OFF of recording head arm each time the button is pressed.
	Ejects the disc

SECTION 5 ELECTRICAL ADJUSTMENTS

5-1. PARTS REPLACEMENT AND ADJUSTMENT

- Check and adjust the MDM and MBU as follows.
The procedure changes according to the part replaced

- Abbreviation
OP : Optical pick-up
OWH: Overwrite head

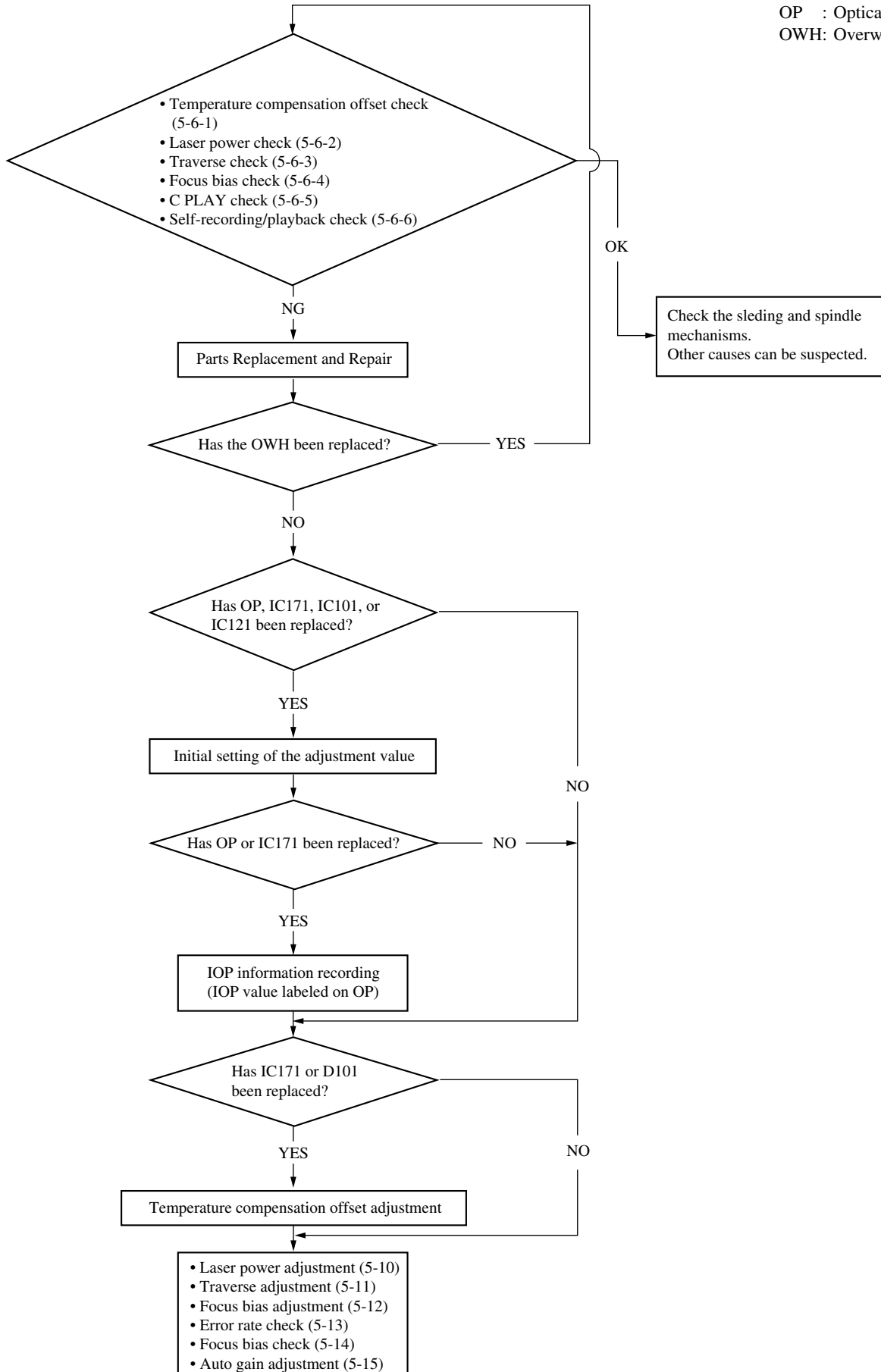

5-2. PRECAUTIONS FOR CHECKING LASER DIODE EMISSION

To check the emission of the laser diode during adjustments, never view directly from the top as this may lose your eye-sight.

5-3. PRECAUTIONS FOR USE OF OPTICAL PICK-UP (KMS-260B)

As the laser diode in the optical pick-up is easily damaged by static electricity, solder the laser tap of the flexible board when using it. Before disconnecting the connector, desolder first. Before connecting the connector, be careful not to remove the solder. Also take adequate measures to prevent damage by static electricity. Handle the flexible board with care as it breaks easily.

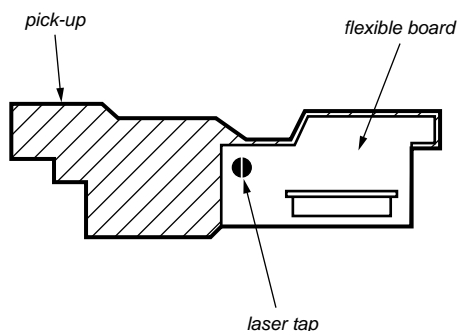

Optical pick-up flexible board

5-4. PRECAUTIONS FOR ADJUSTMENTS

1) When replacing the following parts, perform the adjustments and checks with ○ in the order shown in the following table.

	Optical Pick-up	BD Board			
		IC171	D101	IC101, IC121	IC192
1. Initial setting of adjustment value	○	○	×	○	×
2. Recording of IOP information (Value written in the pick-up)	○	○	×	×	×
3. Temperature compensation offset adjustment	×	○	○	×	×
4. Laser power adjustment	○	○	×	○	○
5. Traverse adjustment	○	○	×	○	×
6. Focus bias adjustment	○	○	×	○	×
7. Error rate check	○	○	×	○	×
8. Auto gain output level adjustment	○	○	×	○	×

- 2) Set the test mode when performing adjustments.
After completing the adjustments, exit the test mode.
Perform the adjustments and checks in "group S" of the test mode.
- 3) Perform the adjustments to be needed in the order shown.

- 4) Use the following tools and measuring devices.
 - Check Disc (MD) TDYS-1 (Parts No. 4-963-646-01)
 - Test Disk (MDW-74/AGA-1) (Parts No. 4-229-747-01)
 - Laser power meter LPM-8001 (Parts No. J-2501-046-A)
 or
 - MD Laser power meter 8010S (Parts No. J-2501-145-A)
 - Oscilloscope (Measure after performing CAL of prove.)
 - Digital voltmeter
 - Thermometer
 - Jig for checking BD board waveform (Parts No. : J-2501-149-A)
- 5) When observing several signals on the oscilloscope, etc., make sure that VC and ground do not connect inside the oscilloscope.
(VC and ground will become short-circuited.)
- 6) Using the above jig enables the waveform to be checked without the need to solder.
(Refer to Servicing Note on page 6.)
- 7) As the disc used will affect the adjustment results, make sure that no dusts nor fingerprints are attached to it.

5-5. CREATING CONTINUOUSLY RECORDED DISC

* This disc is used in focus bias adjustment and error rate check.

The following describes how to create a continuous recording disc.

1. Insert a disc (blank disc) commercially available.
2. Rotate the knob and display "MD CREC MODE".
3. Press the button again to display "MD CREC MID". Display "MD CREC (0300)" and start to recording.
4. Complete recording within 5 minutes.
5. Press the button and stop recording .
6. Press the button and remove the disc.

The above has been how to create a continuous recorded data for the focus bias adjustment and error rate check.

Note :

- Be careful not to apply vibration during continuous recording.

5-6. CHECKS PRIOR TO REPAIRS

These checks are performed before replacing parts according to “approximate specifications” to determine the faulty locations. For details, refer to “Checks Prior to Parts Replacement and Adjustments” (See page 9).

5-6-1. Temperature Compensation Offset Check

When performing adjustments, set the internal temperature and room temperature to 22 to 28°C.

Checking Procedure:

1. Rotate the $\llbracket \leftarrow \rightarrow \rrbracket$ knob to display “MD TEMP CHECK”.
2. Press the $\llbracket \text{ENTER/YES} \rrbracket$ button.
3. “MD T=@@ (##) [OK]” should be displayed. If “MD T=@@ (##) [NG]” is displayed, it means that the results are bad. (@@ indicates the current value set, and ## indicates the value written in the non-volatile memory.)

5-6-2. Laser Power Check

Before checking, check the IOP value of the optical pick-up. (Refer to 5-8. Recording and Displaying the IOP Information.)

Connection :

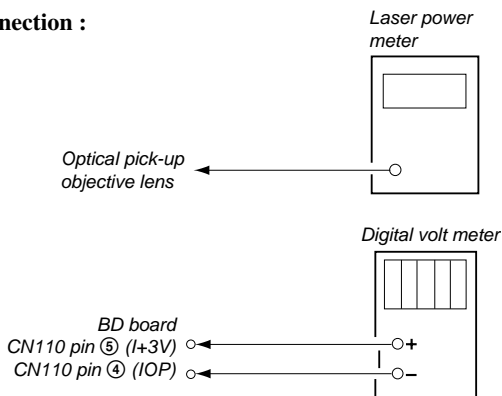

Checking Procedure:

1. Set the laser power meter on the objective lens of the optical pick-up. (When it cannot be set properly, press the $\llbracket \leftarrow \rrbracket$ button or $\llbracket \rightarrow \rrbracket$ button to move the optical pick-up.) Connect the digital volt meter to CN110 pin ⑤ (I+3V) and CN110 pin ④ (IOP).
2. Then, rotate the $\llbracket \leftarrow \rightarrow \rrbracket$ knob and display “MD LDPWR CHECK”.
3. Press the $\llbracket \text{ENTER/YES} \rrbracket$ button once and display “MD 0.9 mW *** \$ []”. Check that the reading of the laser power meter become 0.84 to 0.92 mW. (***) means IOP value)
4. Press the $\llbracket \text{ENTER/YES} \rrbracket$ button once more and display “MD 7.0 mW *** \$ []”. Check that the reading the laser power meter and digital volt meter satisfy the specified value.

Specified Value :

Laser power meter reading : 7.0 ± 0.2 mW

Digital voltmeter reading : Optical pick-up displayed value $\pm 10\%$

(Optical pick-up label)

KMS260A
27X40
B0825

(For details of the method for checking this value, refer to “5-8. Recording and Displaying the IOP Information.”)

$I_{op} = 82.5$ mA in this case

I_{op} (mA) = Digital voltmeter reading (mV)/1 (Ω)

5. Press the $\llbracket \text{MENU/NO} \rrbracket$ button and display “MD LDPWR CHECK” and stop the laser emission. (The $\llbracket \text{MENU/NO} \rrbracket$ button is effective at all times to stop the laser emission.)

Note 1: After step 4, each time the $\llbracket \text{ENTER/YES} \rrbracket$ button is pressed, the display will be switched between “MD LD 0.7 mW \$ []”, “MD LD 0.7 mW \$ []”, “MD LD 6.2 mW \$ []”, “MD LD WP ホセイ \$ []”, “MD LD 0.9 mW \$ []”. Nothing needs to be performed here.

5-6-3. Traverse Check

Connection :

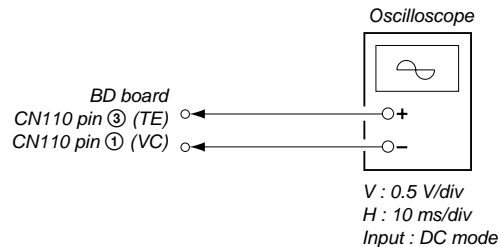

Checking Procedure:

1. Connect an oscilloscope to CN110 pin ③ (TE) and CN110 pin ① (VC) of the BD board.
2. Load a disc (any available on the market). (Refer to Note 1.)
3. Press the $\llbracket \leftarrow \rrbracket$ button and move the optical pick-up outside the pit.
4. Rotate the $\llbracket \leftarrow \rightarrow \rrbracket$ knob and display “MD EF MO CHECK”.
5. Press the $\llbracket \text{ENTER/YES} \rrbracket$ button and display “MD EFB = [] MO-R”. (Laser power READ power/Focus servo ON/tracking servo OFF/spindle (S) servo ON)
6. Observe the waveform of the oscilloscope, and check that the specified value is satisfied. Do not rotate the $\llbracket \leftarrow \rightarrow \rrbracket$ knob. (Read power traverse checking)

(Traverse Waveform)

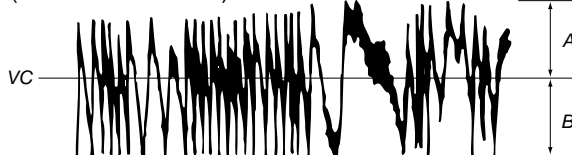

Specified value : Below 10% offset value

$$\text{Offset value (\%)} = \frac{|A - B|}{2(A + B)} \times 100$$

7. Press the $\llbracket \text{ENTER/YES} \rrbracket$ button and display “MD EFB = [] MO-W”.
8. Observe the waveform of the oscilloscope, and check that the specified value is satisfied. Do not rotate the $\llbracket \leftarrow \rightarrow \rrbracket$ knob. (Write power traverse checking)

(Traverse Waveform)

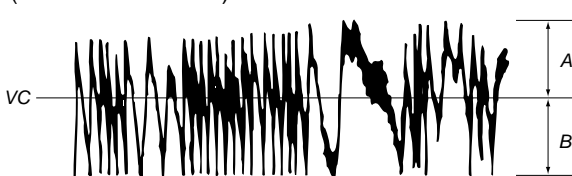

Specified value : Below 10% offset value

$$\text{Offset value (\%)} = \frac{|A - B|}{2(A + B)} \times 100$$

9. Press the $\llbracket \text{ENTER/YES} \rrbracket$ button display “MD EFB = [] MO-P”. Then, the optical pick-up moves to the pit area automatically and servo is imposed.

10. Observe the waveform of the oscilloscope, and check that the specified value is satisfied. Do not rotate the ◀ button or ▶ button.

(Traverse Waveform)

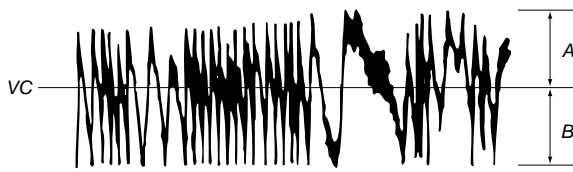

Specified value : Below 10% offset value

$$\text{Offset value (\%)} = \frac{|A - B|}{2(A + B)} \times 100$$

11. Press the [ENTER/YES] button display “MD EF MO CHECK”
The disc stops rotating automatically.
12. Press the [⏏] button and remove the disc.
13. Load the check disc (MD) TDYS-1.
14. Rotate the [◀▶] knob and display “MD EF CD CHECK”.
15. Press the [ENTER/YES] button and display “MD EFB = [] CD”. Servo is imposed automatically.
16. Observe the waveform of the oscilloscope, and check that the specified value is satisfied. Do not rotate the ◀ button or ▶ button.

(Traverse Waveform)

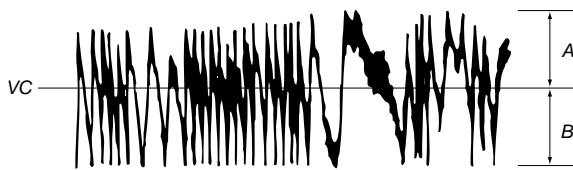

Specified value : Below 10% offset value

$$\text{Offset value (\%)} = \frac{|A - B|}{2(A + B)} \times 100$$

17. Press the [ENTER/YES] button and display “MD EF CD CHECK”.
18. Press the [⏏] button and remove the check disc (MD) TDYS-1.

Note 1 : MO reading data will be erased during if a recorded disc is used in this adjustment.

Note 2 : If the traverse waveform is not clear, connect the oscilloscope as shown in the following figure so that it can be seen more clearly.

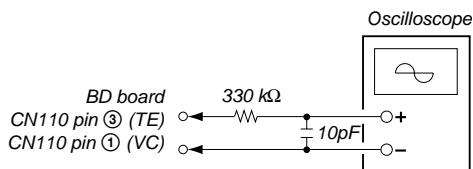

5-6-4. Focus Bias Check

Change the focus bias and check the focus tolerance amount.

Checking Procedure :

1. Load a test disk (MDW-74/GA-1).
 2. Rotate the [◀▶] knob and display “MD CPLAY MODE”.
 3. Press the [ENTER/YES] button twice and display “MD CPLAY MID”.
 4. Press the [MENU/NO] button when “MD C = [] AD = []” is displayed.
 5. Rotate the [◀▶] knob and display “FBIAS CHECK”.
 6. Press the [ENTER/YES] button and display “MD []/[] c = []”.
- The first four digits indicate the C1 error rate, the two digits after [/] indicate ADER, and the 2 digits after [c =] indicate the focus bias value.
- Check that the C1 error is below 220 and ADER is below 2.
7. Press the [ENTER/YES] button and display “MD []/[] b = []”.
- Check that the C1 error is below 220 and ADER is below 2.
8. Press the [ENTER/YES] button and display “MD []/[] a = []”.
- Check that the C1 error is below 220 and ADER is below 2.
9. Press the [MENU/NO] button, next press the [⏏] button, and remove the test disc.

5-6-5. C PLAY Check

MO Error Rate Check

Checking Procedure :

1. Load a test disk (MDW-74/GA-1).
2. Rotate the [◀▶] knob and display “MD CPLAY MODE”.
3. Press the [ENTER/YES] button and display “MD CPLAY MID”.
4. The display changes to “MD C1 = [] AD = []”.
5. If the C1 error rate is below 80, check that ADER is below 2.
6. Press the [MENU/NO] button, stop playback, press the [⏏] button, and test disc.

CD Error Rate Check

Checking Procedure :

1. Load a check disc (MD) TDYS-1.
2. Rotate the [◀▶] knob and display “MD CPLAY MODE”.
3. Press the [ENTER/YES] button twice and display “MD CPLAY MID”.
4. The display changes to “MD C1 = [] AD = []”.
5. Check that the C1 error rate is below 50.
6. Press the [MENU/NO] button, stop playback, press the [⏏] button, and the test disc.

5-6-6. Self-Recording/playback Check

Prepare a continuous recording disc using the unit to be repaired and check the error rate.

Checking Procedure :

1. Insert a recordable disc (blank disc) into the unit.
2. Rotate the [◀▶] knob to display “MD CREC MODE”.
3. Press the [ENTER/YES] button to display the “MD CREC MID”.
4. When recording starts, this becomes “MD CREC (@@@@)” (@@@@ is the address), and recording starts.
5. About 1 minute later, press the [MENU/NO] button to stop continuous recording.
6. Rotate the [◀▶] knob to display “MD CPLAY MODE”.
7. Press the [ENTER/YES] button to display “MD CPLAY MID”.
8. “MD C1 = [] AD = []” will be displayed.
9. Check that the C1 error becomes below 80 and the AD error below 2.
10. Press the [MENU/NO] button to stop playback, and press the [⏏] button and remove the disc.

5-7. INITIAL SETTING OF ADJUSTMENT VALUE



Note:

Mode which sets the adjustment results recorded in the non-volatile memory to the initial setting value. However the results of the temperature compensation offset adjustment will not change to the initial setting value.

If initial setting is performed, perform all adjustments again excluding the temperature compensation offset adjustment.

For details of the initial setting, refer to “5-4. Precautions for Adjustments” and execute the initial setting before the adjustment as required.













Setting Procedure :

1. Rotate the  knob to display “MD ADJ CLEAR”.
2. Press the  button. “Complete!!” will be displayed momentarily and initial setting will be executed, after which “MD ADJ CLEAR” will be displayed.

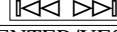

5-8. RECORDING AND DISPLAYING THE IOP INFORMATION

The IOP data can be recorded in the non-volatile memory. The IOP value on the label of the optical pick-up and the IOP value after the adjustment will be recorded. Recording these data eliminates the need to read the label on the optical pick-up.

Recording Procedure :

1. When the power OFF (STANDBY), press the  button (TA) while pressing the  button and  button together.
2. Press the  button, and when “Check” is displayed.
3. Rotate the  knob to display “MD [Service]”, and press the  button.
4. Rotate the  knob to display “MD Iop Write”, and press the  button.
5. The display becomes Ref=@@.@ (@ is an arbitrary number) and the numbers which can be changed will blink.
6. Input the IOP value written on the optical pick-up.
To select the number : Rotate the  knob.
To select the digit : Press the  button.
7. When the  button is pressed, the display becomes “MD Measu=@@.@.” (@ is an arbitrary number).
8. As the adjustment results are recorded for the 7 value. Leave it as it is and press the  button.
9. “Complete!!” will be displayed momentarily. The value will be recorded in the non-volatile memory and the display will become “MD Iop Write”.

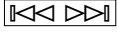
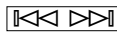
Display Procedure :

1. Rotate the  knob to display “MD Iop Read”.
2. “MD @@.@/##.#” is displayed and the recorded contents are displayed.
@@.@ indicates the IOP value labeled on the pick-up.
##.# indicates the IOP value after adjustment
3. To end, press the  button or  button to display “MD Iop Read”.







5-9. TEMPERATURE COMPENSATION OFFSET ADJUSTMENT

Save the temperature data at that time in the non-volatile memory as 25 °C reference data.

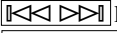
Note :

1. Usually, do not perform this adjustment.
2. Perform this adjustment in an ambient temperature of 22 °C to 28 °C. Perform it immediately after the power is turned on when the internal temperature of the unit is the same as the ambient temperature of 22 °C to 28 °C.
3. When D101 has been replaced, perform this adjustment after the temperature of this part has become the ambient temperature.

Adjusting Procedure :

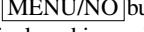
1. Rotate the  knob and display “MD TEMP ADJUST”.
2. Press the  button and select the “MD TEMP ADJUST” mode.
3. “MD TEMP =  [OK]” and the current temperature data will be displayed.
4. To save the data, press the  button.
When not saving the data, press the  button.
5. When the  button is pressed, “MD TEMP =  SAVE” will be displayed and turned back to “MD TEMP ADJUST” display then. When the  button is pressed, “MD TEMP ADJUST” will be displayed immediately.

Specified Value :

The “MD TEMP = ” should be within “E0 - EF”, “F0 - FF”, “00 - 0F”, “10 - 1F” and “20 - 2F”.







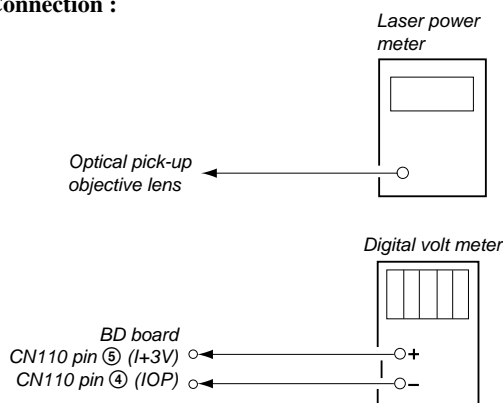

5-10. LASER POWER ADJUSTMENT

Check the IOP value of the optical pick-up before adjustments. (Refer to 5-8. Recording and Displaying the IOP Information.)

Connection :

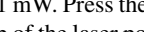

Adjusting Procedure :

1. Set the laser power meter on the objective lens of the optical pick-up. (When it cannot be set properly, press the  button or  button to move the optical pick-up.)
Connect the digital volt meter to CN110 pin 5 (I+3V) and CN110 pin 4 (IOP).
2. Rotate the  knob and display “MD LDPWR ADJUST”.
(Laser power : For adjustment)
3. Press the  button once and display “MD LD 0.9 mW \$ ”.
4. Rotate the  knob so that the reading of the laser power meter becomes 0.85 to 0.91 mW. Press the  button after setting the range knob of the laser power meter, and save the adjustment results. (“MD LD SAVE \$ ” will be displayed for a moment.)

- Then "MD LD 7.0 mW \$ []" will be displayed.
- Rotate the [] knob so that the reading of the laser power meter becomes 6.9 to 7.1 mW, press the [ENTER/YES] button and save it.

Note : Do not perform the emission with 7.0 mW more than 15 seconds continuously.

- Then, rotate the [] knob and display "MD LDPWR CHECK".
- Press the [ENTER/YES] button once and display "MD 0.9 mW *** \$ []". Check that the reading of the laser power meter become 0.85 to 0.91 mW. (***) means the IOP value)
- Press the [ENTER/YES] button once more and display "MD 7.0 mW *** \$ []". Check that the reading the laser power meter and digital volt meter satisfy the specified value.
Note down the digital voltmeter reading value.

Specified Value :

Laser power meter reading : 7.0 ± 0.1 mW

Digital voltmeter reading : Optical pick-up displayed value $\pm 10\%$

(Optical pick-up label)

KMS260A
27X40
B0825

(For details of the method for checking this value, refer to "5-8. Recording and Displaying the IOP Information".)

IOP = 82.5 mA in this case

$IOP (mA) = \text{Digital voltmeter reading (mV)} / 1 (\Omega)$

- Press the [MENU/NO] button and display "MD LDPWR CHECK" and stop the laser emission.
(The [MENU/NO] button is effective at all times to stop the laser emission.)
- Rotate the [] knob to display "MD Iop Write".
- Press the [ENTER/YES] button. When the display becomes Ref=@@.@ (@ is an arbitrary number), press the [ENTER/YES] button to display "MD Measu=@@.@." (@ is an arbitrary number).
- The numbers which can be changed will blink. Input the IOP value noted down at step 9.
To select the number : Rotate the [] knob.
To select the digit : Press the [SYNCHRO REC] button.
Selection of digit : Press the [SYNCHRO REC] button.
- When the [ENTER/YES] button is pressed, "Complete!" will be displayed momentarily. The value will be recorded in the non-volatile memory and the display will become "MD Iop Write".

Note 1: After step 4, each time the [ENTER/YES] button is pressed, the display will be switched between "MD 0.7 mW *** \$ []", "MD 6.2 mW *** \$ []", and "MD Wp ホセイ *** \$ []". Nothing needs to be performed here.

5-11. TRAVERSE ADJUSTMENT

Connection :

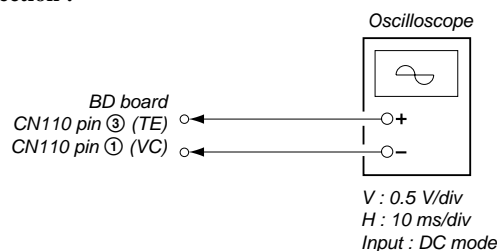

Adjusting Procedure :

- Connect an oscilloscope to CN110 pin ③ (TE) and CN110 pin ① (VC) of the BD board.
- Load a disc (any available on the market). (Refer to Note 1.)
- Press the [] button and move the optical pick-up outside the pit.
- Rotate the [] knob and display "MD EF MO ADJUST".
- Press the [ENTER/YES] button and display "MD EFB = [] MO-R".
(Laser power READ power/Focus servo ON/tracking servo OFF/spindle (S) servo ON)
- Rotate the [] knob so that the waveform of the oscilloscope becomes the specified value.
(When the [] knob is rotated, the [] of "MD EFB = []" changes and the waveform changes.) In this adjustment, waveform varies at intervals of approx. 2%. Adjust the waveform so that the specified value is satisfied as much as possible. (Read power traverse adjustment)

(Traverse Waveform)

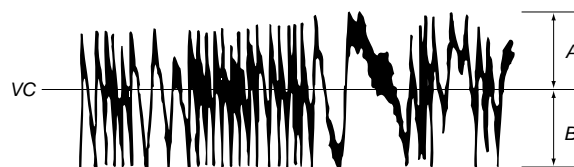

Specification A = B

- Press the [ENTER/YES] button and save the result of adjustment to the non-volatile memory ("MD EFB = [] SAVE" will be displayed for a moment. Then "MD EFB = [] MO-W" will be displayed).
- Rotate the [] knob so that the waveform of the oscilloscope becomes the specified value.
(When the [] knob is rotated, the [] of "MD EFB = []" changes and the waveform changes.) In this adjustment, waveform varies at intervals of approx. 2%. Adjust the waveform so that the specified value is satisfied as much as possible.
(Write power traverse adjustment)

(Traverse Waveform)

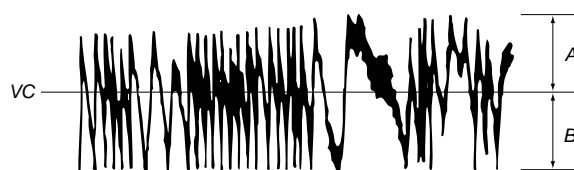

Specification A = B

9. Press the **ENTER/YES** button, and save the adjustment results in the non-volatile memory. (“MD EFB = **000** SAVE” will be displayed for a moment.)
10. “MD EFB = **000** MO-P”. will be displayed.
The optical pick-up moves to the pit area automatically and servo is imposed.
11. Rotate the **◀◀ ▶▶** knob until the waveform of the oscilloscope moves closer to the specified value.
In this adjustment, waveform varies at intervals of approx. 2%. Adjust the waveform so that the specified value is satisfied as much as possible.

(Traverse Waveform)

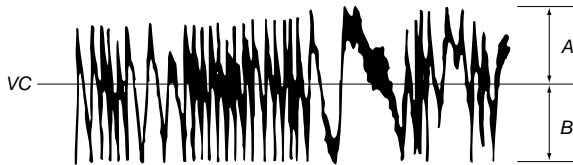

Specification A = B

12. Press the **ENTER/YES** button, and save the adjustment results in the non-volatile memory. (“MD EFB = **000** SAVE” will be displayed for a moment.)
Next “MD EF MO ADJUST” is displayed. The disc stops rotating automatically.
13. Press the **⏏** button and remove the disc.
14. Load the check disc (MD) TDYS-1.
15. Rotate **◀◀ ▶▶** knob and display “MD EF CD ADJUST”.
16. Press the **ENTER/YES** button and display “MD EFB = **000** CD”. Servo is imposed automatically.
17. Rotate the **◀◀ ▶▶** knob so that the waveform of the oscilloscope moves closer to the specified value.
In this adjustment, waveform varies at intervals of approx. 2%. Adjust the waveform so that the specified value is satisfied as much as possible.

(Traverse Waveform)

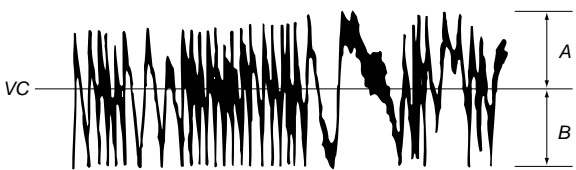

Specification A = B

18. Press the **ENTER/YES** button, display “MD EFB = **000** SAVE” for a moment and save the adjustment results in the non-volatile memory.
Next “MD EF CD ADJUST” will be displayed.
19. Press the **⏏** button and remove the check disc (MD) TDYS-1.

Note 1 : MO reading data will be erased during if a recorded disc is used in this adjustment.

Note 2 : If the traverse waveform is not clear, connect the oscilloscope as shown in the following figure so that it can be seen more clearly.

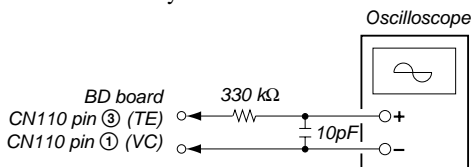

5-12. FOCUS BIAS ADJUSTMENT

Adjusting Procedure :

1. Load a test disk (MDW-74/GA-1).
2. Rotate the **◀◀ ▶▶** knob and display “MD CPLAY MODE”.
3. Press the **ENTER/YES** button and display “MD CPLAY MID”.
4. Press the **MENU/NO** button when “MD C1 = **0000** AD = **00**” is displayed.
5. Rotate the **◀◀ ▶▶** knob and display “MD FBIAS ADJUST”.
6. Press the **ENTER/YES** button and display “MD **0000/00** a = **00**”.
The first four digits indicate the C1 error rate, the two digits after [/] indicate ADER, and the 2 digits after [a =] indicate the focus bias value.
7. Rotate the **◀◀ ▶▶** knob in the clockwise direction and find the focus bias value at which the C1 error rate becomes 220 (Refer to Note 2).
8. Press the **ENTER/YES** button and display “MD **0000/00** b = **00**”.
9. Rotate the **◀◀ ▶▶** knob in the counterclockwise direction and find the focus bias value at which the C1 error rate becomes 220.
10. Press the **ENTER/YES** button and display “MD **0000/00** c = **00**”.
11. Check that the C1 error rate is below 50 and ADER is 00. Then press the **ENTER/YES** button.
12. If the “()” in “() - () - ()” is above 20, press the **ENTER/YES** button.
If below 20, press the **MENU/NO** button and repeat the adjustment from step 2.
13. Press the **⏏** button to remove the test disc.

Note 1 : The relation between the C1 error and focus bias is as shown in the following figure. Find points a and b in the following figure using the above adjustment. The focal point position C is automatically calculated from points a and b.

Note 2 : As the C1 error rate changes, perform the adjustment using the average value.

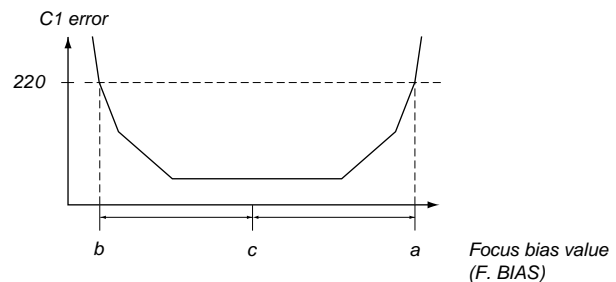

5-13. ERROR RATE CHECK

5-13-1. CD Error Rate Check

Checking Procedure :

1. Load a check disc (MD) TDYS-1.
2. Rotate the [◀◀ ▶▶] knob and display “MD CPLAY MODE”.
3. Press the [ENTER/YES] button twice and display “MD CPLAY MID”.
4. The display changes to “MD C1 = [] AD = []”.
5. Check that the C1 error rate is below 20.
6. Press the [MENU/NO] button, stop playback, press the [⏏] button, and remove the test disc.

5-13-2. MO Error Rate Check

Checking Procedure :

1. Load a test disc (MDW-74/GA-1).
2. Rotate the [◀◀ ▶▶] knob and display “MD CPLAY MODE”.
3. Press the [ENTER/YES] button and display “MD CPLAY MID”.
4. The display changes to “MD C1 = [] AD = []”.
5. If the C1 error rate is below 50, check that ADER is 00.
6. Press the [MENU/NO] button, stop playback, press the [⏏] button, and remove the test disc.

5-14. FOCUS BIAS CHECK

Change the focus bias and check the focus tolerance amount.

Checking Procedure :

1. Load a test disc (MDW-74/GA-1).
2. Rotate the [◀◀ ▶▶] knob and display “MD CPLAY MODE”.
3. Press the [ENTER/YES] button twice and display “MD CPLAY MID”.
4. Press the [MENU/NO] button when “MD C1 = [] AD = []” is displayed.
5. Rotate the [◀◀ ▶▶] knob and display “MD FBIAS CHECK”.
6. Press the [ENTER/YES] button and display “MD []/[] c = []”.

The first four digits indicate the C1 error rate, the two digits after [/] indicate ADER, and the 2 digits after [c =] indicate the focus bias value.

Check that the C1 error is below 50 and ADER is below 2.

7. Press the [ENTER/YES] button and display “MD []/[] b = []”.

Check that the C1 error is below 220 and ADER is below 2.

8. Press the [ENTER/YES] button and display “MD []/[] a = []”.

Check that the C1 error is below 220 and ADER is below 2

9. Press the [MENU/NO] button, next press the [⏏] button, and remove the continuously recorded disc.

Note 1 : If the C1 error and ADER are above other than the specified value at points a (step 8. in the above) or b (step 7. in the above), the focus bias adjustment may not have been carried out properly. Adjust perform the beginning again.

5-15. AUTO GAIN CONTROL OUTPUT LEVEL ADJUSTMENT

Be sure to perform this adjustment when the pick-up is replaced. If the adjustment results becomes “Adjust NG!”, the pick-up may be faulty or the servo system circuits may be abnormal.

5-15-1. CD Auto Gain Control Output Level Adjustment

Adjusting Procedure :

1. Insert the check disc (MD) TDYS-1.
2. Rotate the [◀◀ ▶▶] knob to display “MD AG Set (CD)”.
3. When the [ENTER/YES] button is pressed, the adjustment will be performed automatically. “Complete!” will then be displayed momentarily when the value is recorded in the non-volatile memory, after which the display changes to “MD AG Set (CD)”.
4. Press the [⏏] button to remove the disc.

5-15-2. MO Auto Gain Control Output Level Adjustment

Adjusting Procedure :

1. Insert the reference disc (MDW-74/GA-1) for recording.
2. Rotate the [◀◀ ▶▶] knob to display “MD AG Set (MO)”.
3. When the [ENTER/YES] button is pressed, the adjustment will be performed automatically. “Complete!” will then be displayed momentarily when the value is recorded in the non-volatile memory, after which the display changes to “MD AG Set (MO)”.
4. Press the [⏏] button to remove the disc.

5-16. ADJUSTING POINTS AND CONNECTING POINTS

[BD BOARD] (SIDE A)

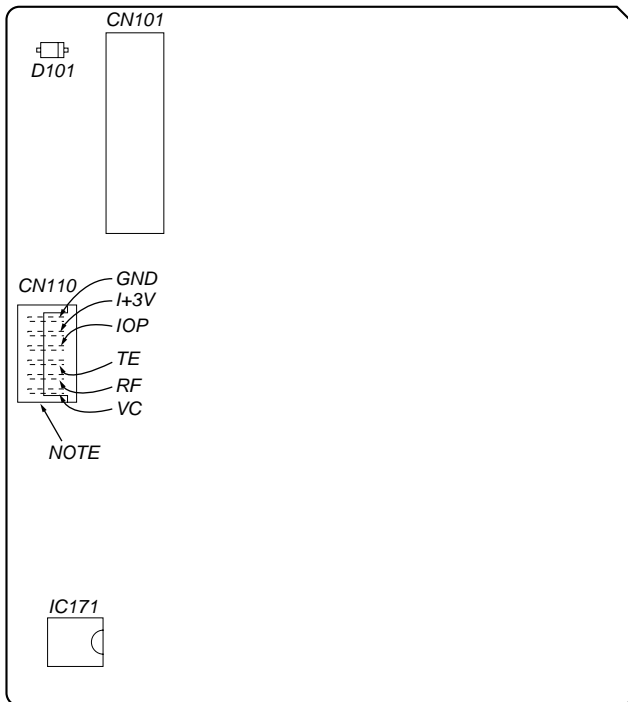

[BD BOARD] (SIDE B)

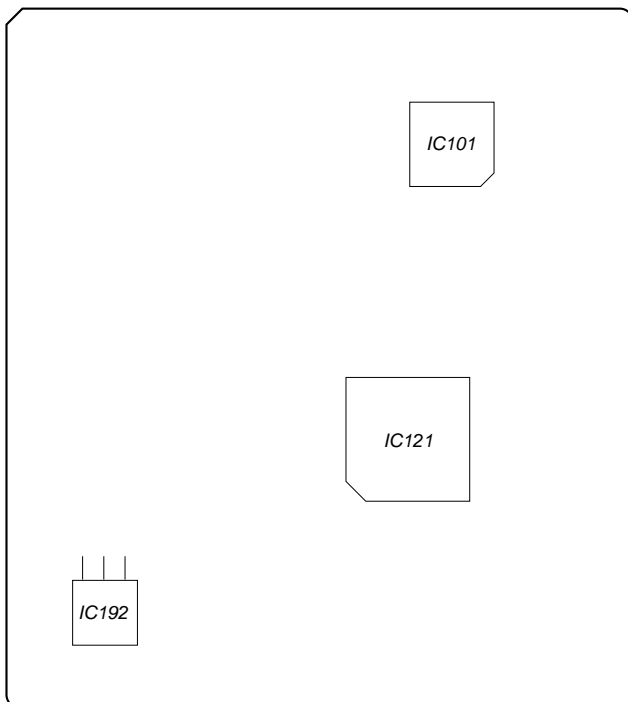

NOTE: It is useful to use the jig. for checking the waveform.
(Refer to Servicing Note on page 7.)

SECTION 6 DIAGRAMS

THIS NOTE IS COMMON FOR PRINTED WIRING BOARDS AND SCHEMATIC DIAGRAMS.
(In addition to this, the necessary note is printed in each block.)

For schematic diagrams.

Note:

- All capacitors are in μF unless otherwise noted. pF: $\mu\mu\text{F}$ 50 WV or less are not indicated except for electrolytics and tantalums.
- All resistors are in Ω and $1/4\text{W}$ or less unless otherwise specified.
- Δ : internal component.
- \square : panel designation.

Note: The components identified by mark Δ or dotted line with mark Δ are critical for safety.
Replace only with part number specified.

- $\boxed{\text{B}+}$: B+ Line.
- $\boxed{\text{B}-}$: B- Line.
- \square : adjustment for repair.
- no mark : STOP
- () : Play the test disc (TDYS-1)
- < : REC
- > : REC
- * : Can not be measured.
- Voltages are taken with a VOM (Input impedance 10 M Ω). Voltage variations may be noted due to normal production tolerances.
- Waveforms are taken with a oscilloscope. Voltage variations may be noted due to normal production tolerances.
- Circled numbers refer to waveforms.
- Signal path.
- Σ : PB
- \blacktriangleright : REC
- $\Sigma \gg$: PB (DIGITAL)
- $\blacktriangleright \gg$: REC (DIGITAL)

For printed wiring boards.

Note:

- \circ : parts extracted from the component side.
- --- : parts extracted from the conductor side.
- \circ : Through hole.
- --- : Pattern from the side which enables seeing. (The other layers' patterns are not indicated.)

Caution:

Pattern face side: Parts on the pattern face side seen from the (Side B) pattern face are indicated.
Parts face side: Parts on the parts face side seen from the (Side A) parts face are indicated.

• Indication of transistor

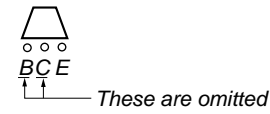
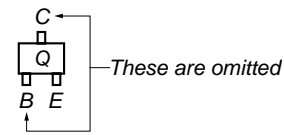

WAVEFORMS

– BD (1/2) SECTION –

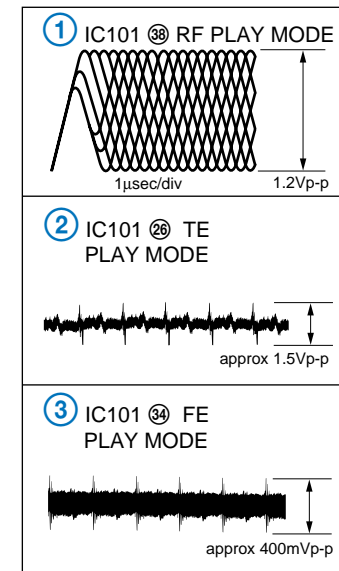

– MAIN SECTION –

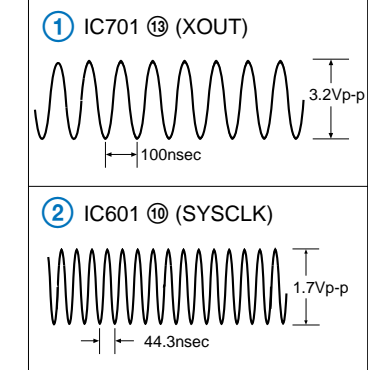

– BD (2/2) SECTION –

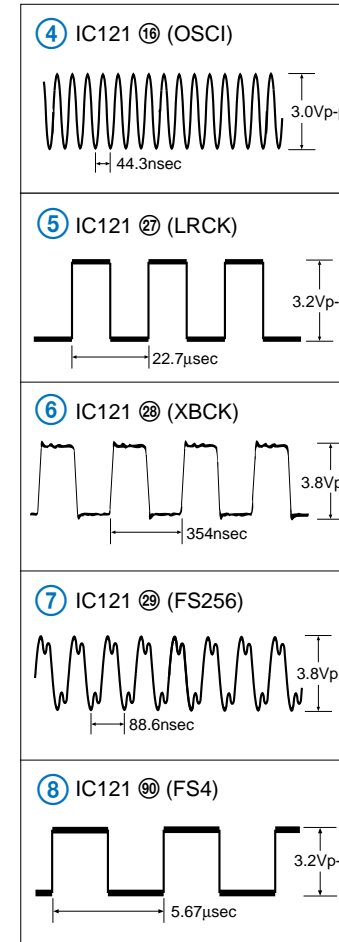

6-1. BLOCK DIAGRAMS
- BD SECTION -

DIGITAL SERVO SIGNAL PROCESSOR, DIGITAL SIGNAL PROCESSOR
EFM/ACIRC ENCODER/DECODER, SHOCK-PROOF MEMORY CONTROLLER,
ATRAC ENCODER/DECODER
IC121

- R-ch is omitted.
- Signal path
- : PB
- : REC
- : PB (Digital)
- : REC (Digital)

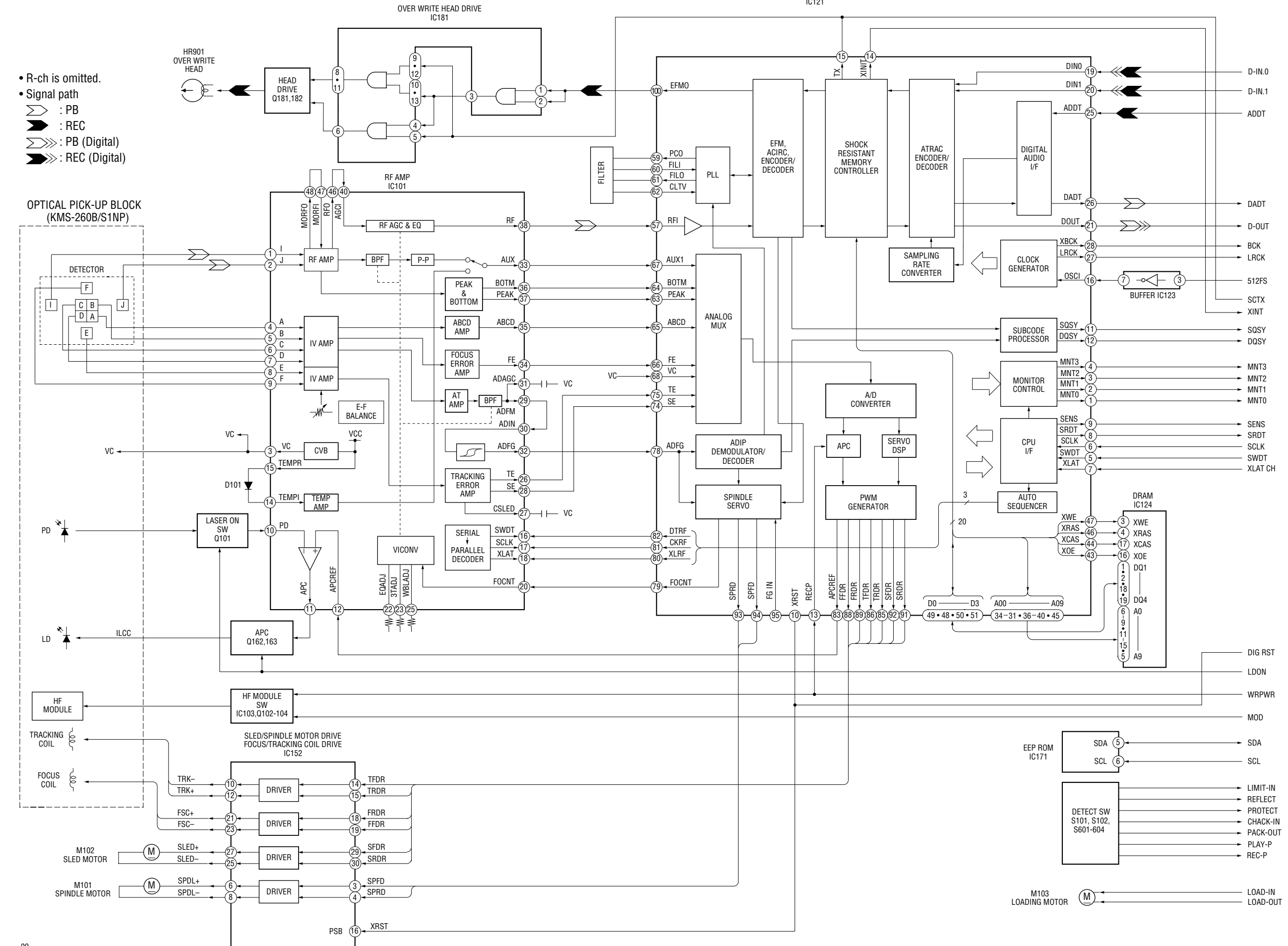

A
MAIN SECTION
(Page 33)

B
MAIN SECTION
(Page 33)

C
MAIN SECTION
(Page 33)

- MAIN SECTION -

A
BD SECTION
(Page 32)

B
BD SECTION
(Page 32)

C
BD SECTION
(Page 32)

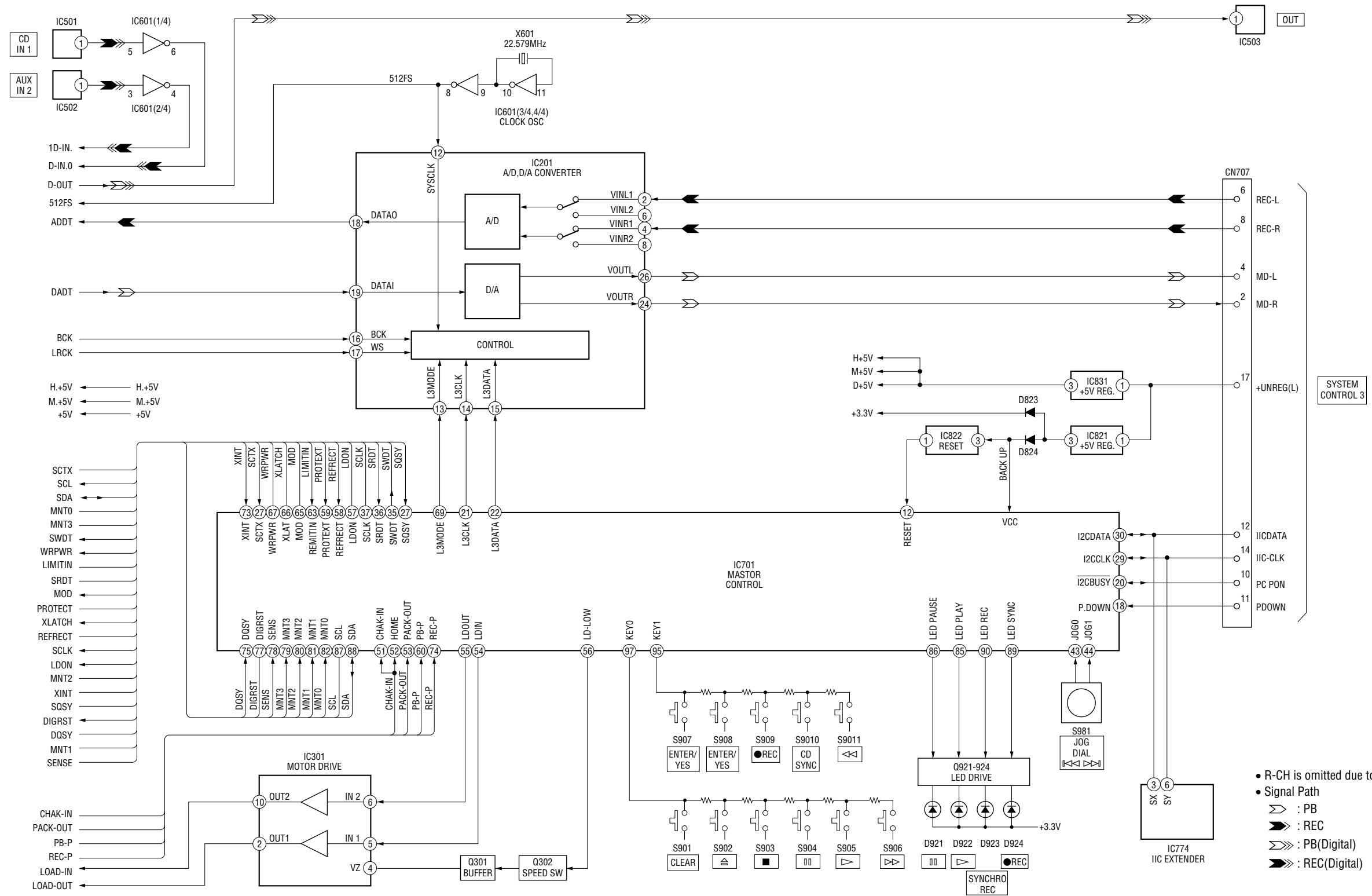

- R-CH is omitted due to same as L-CH.
- Signal Path
- : PB
- : REC
- : PB(Digital)
- : REC(Digital)

6-2. PRINTED WIRING BOARD – BD SECTION –

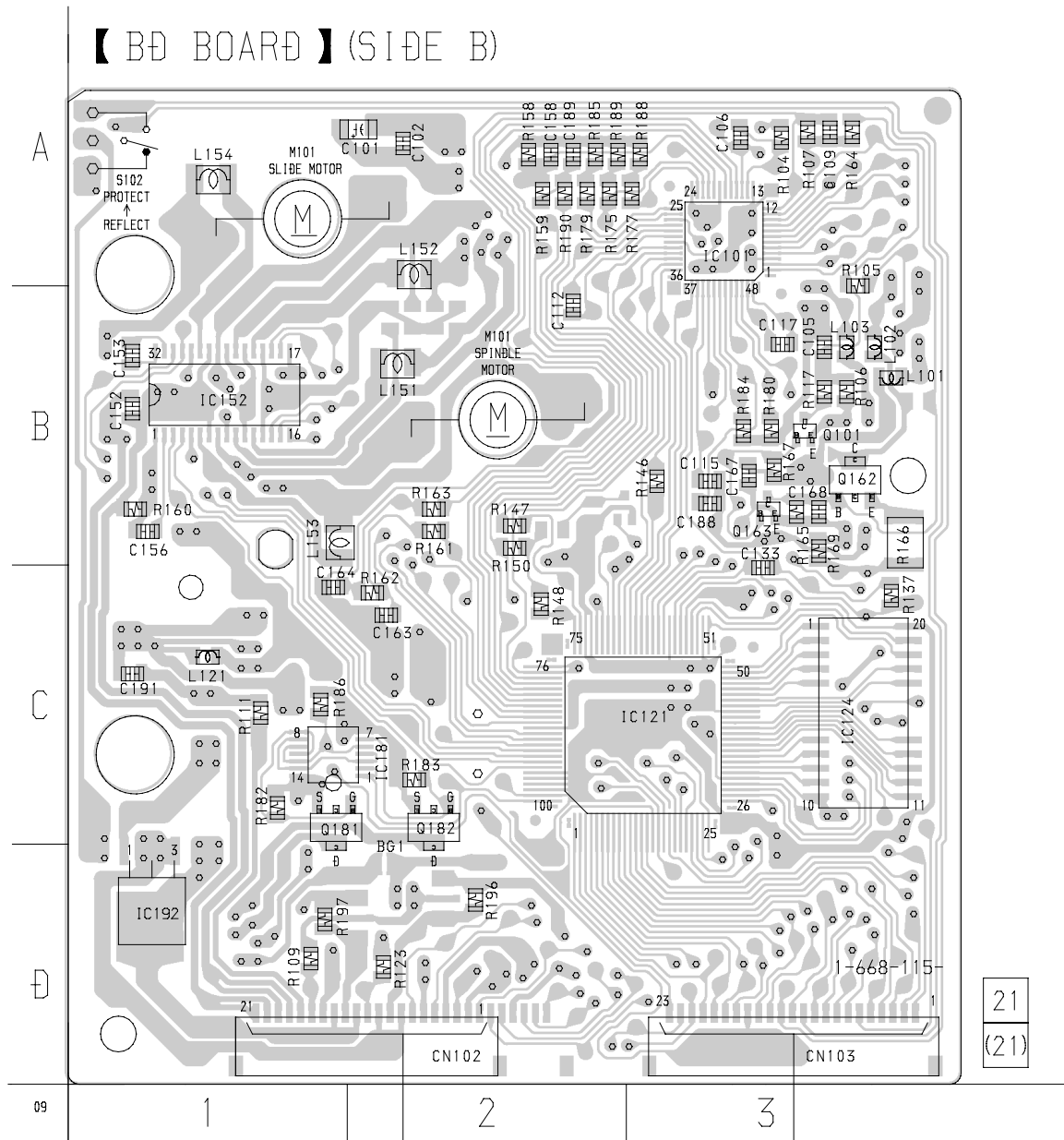
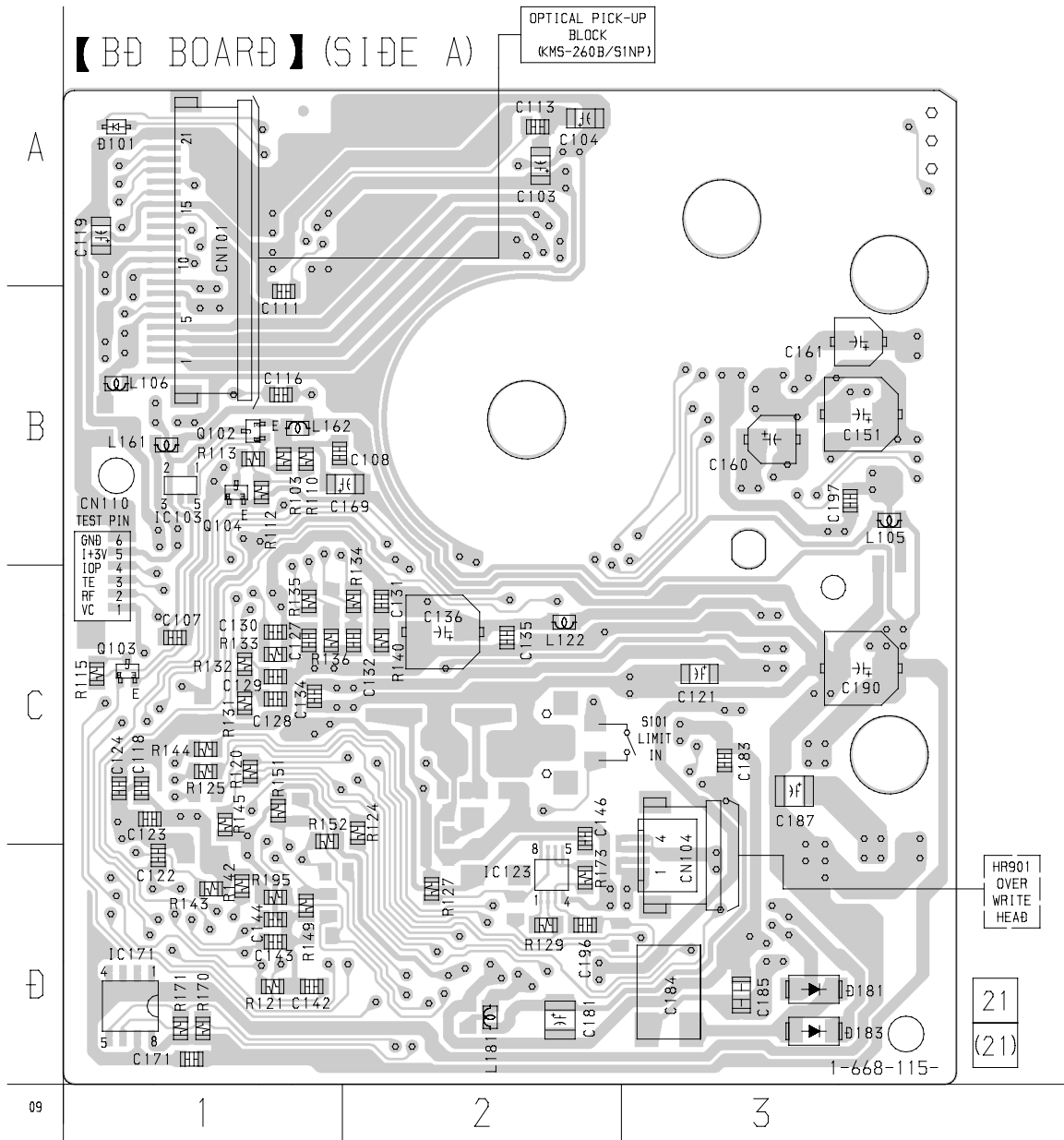

(Page 39) A

(Page 39) B

• Semiconductor Location

Ref. No.	Location
D101	A-1
D181	D-3
D183	D-3
IC103	B-1
IC123	D-2
IC171	D-1
Q102	B-1
Q103	B-1
Q104	B-1

• Semiconductor Location

Ref. No.	Location
IC101	A-3
IC121	C-3
IC124	C-3
IC152	B-1
IC181	C-1
IC192	D-1
Q101	B-3
Q162	B-3
Q163	B-3
Q181	C-1
Q182	C-2

There are a few cases that the part isn't mounted in model is printed on diagram.

6-3. SCHEMATIC DIAGRAM – BD (1/2) SECTION – • See page 31 for Waveforms. • See page 42 for IC Block Diagrams. • See page 45 for IC Pin Functions.

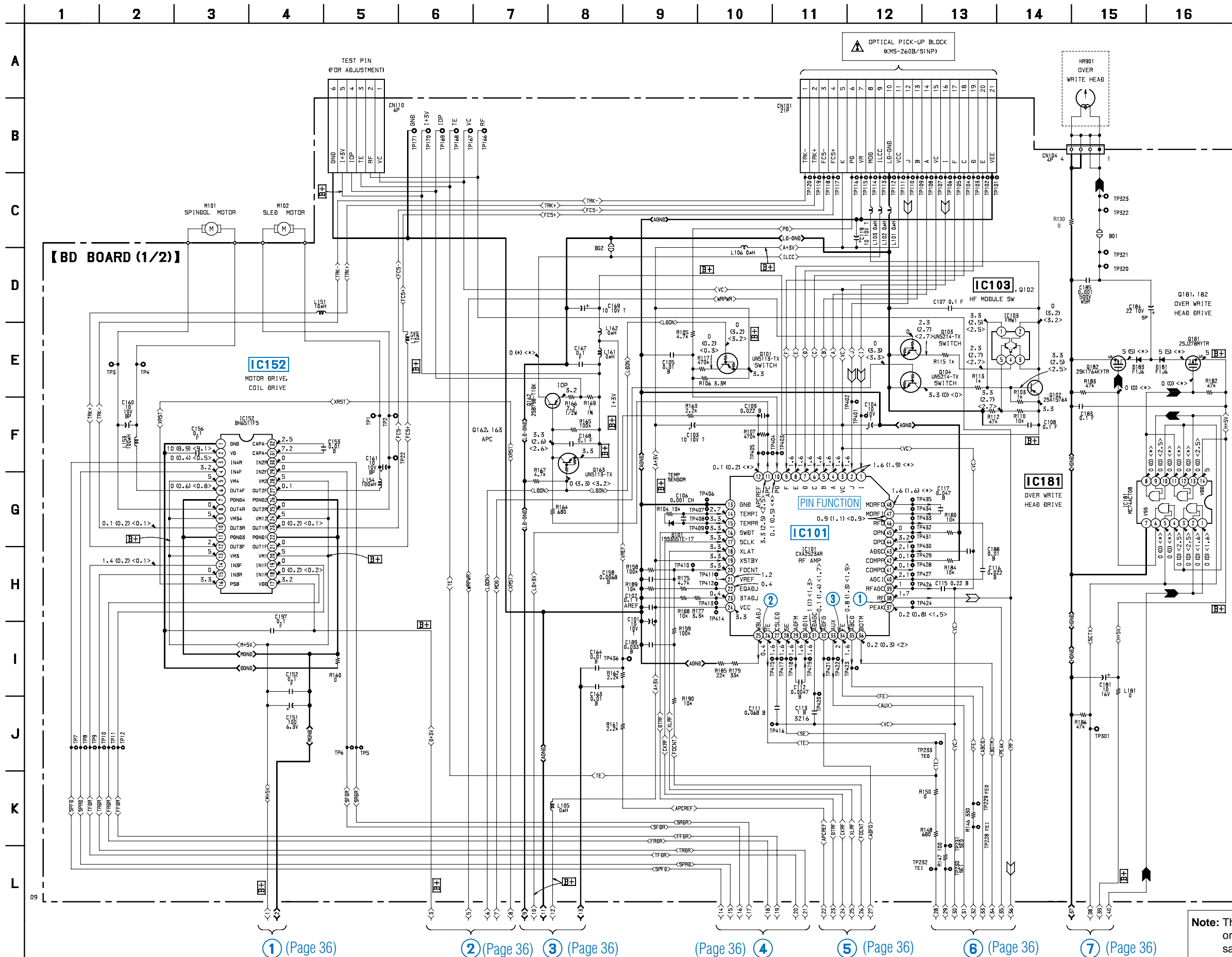

- ① (Page 36)
- ② (Page 36)
- ③ (Page 36)
- (Page 36) ④
- ⑤ (Page 36)
- ⑥ (Page 36)
- ⑦ (Page 36)

Note: The components identified by mark Δ or dotted line with mark Δ are critical for safety. Replace only with part number specified.

6-4. SCHEMATIC DIAGRAM – BD (2/2) SECTION –

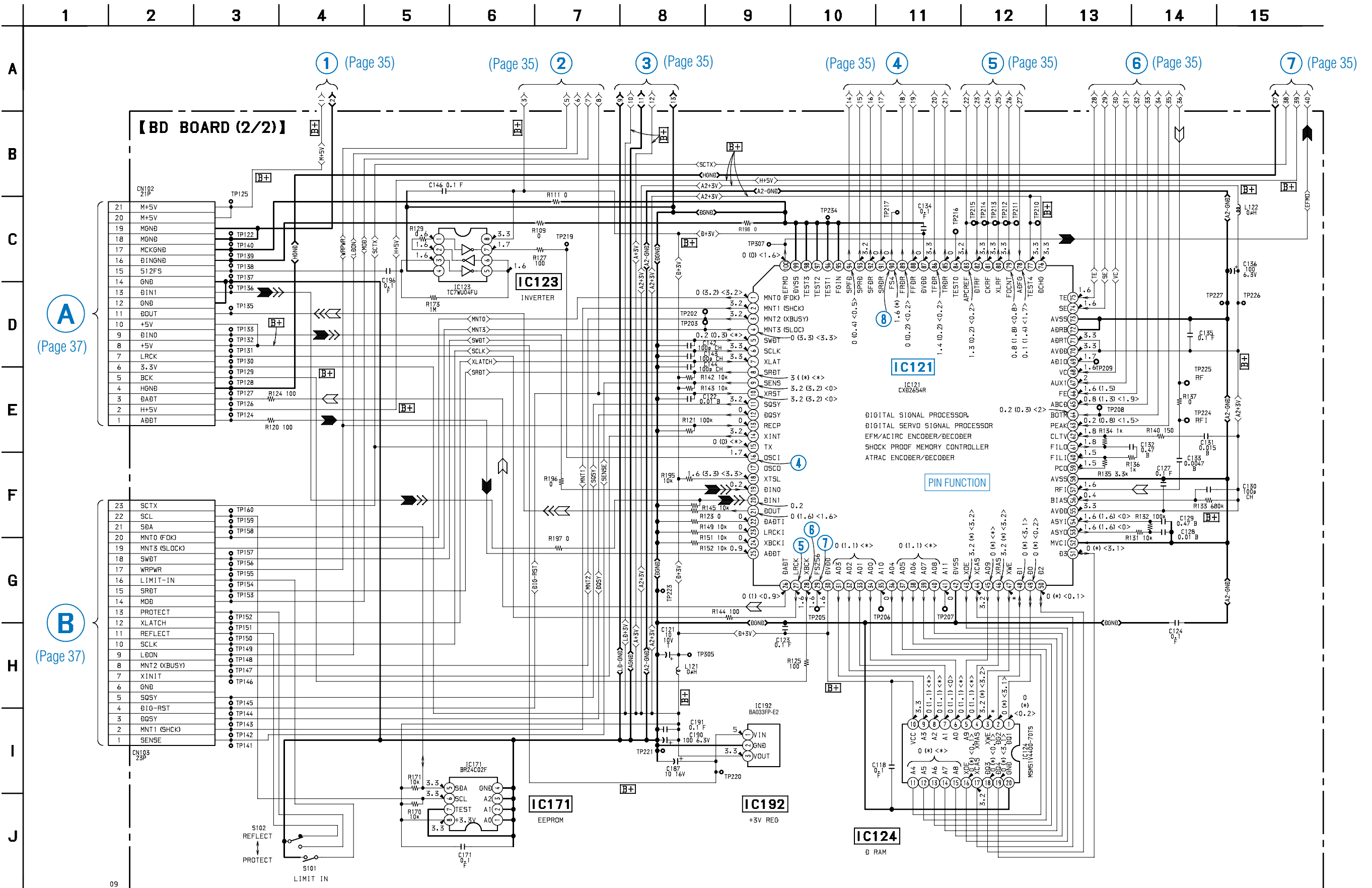

6-5. SCHEMATIC DIAGRAM – MAIN (1/2) SECTION –

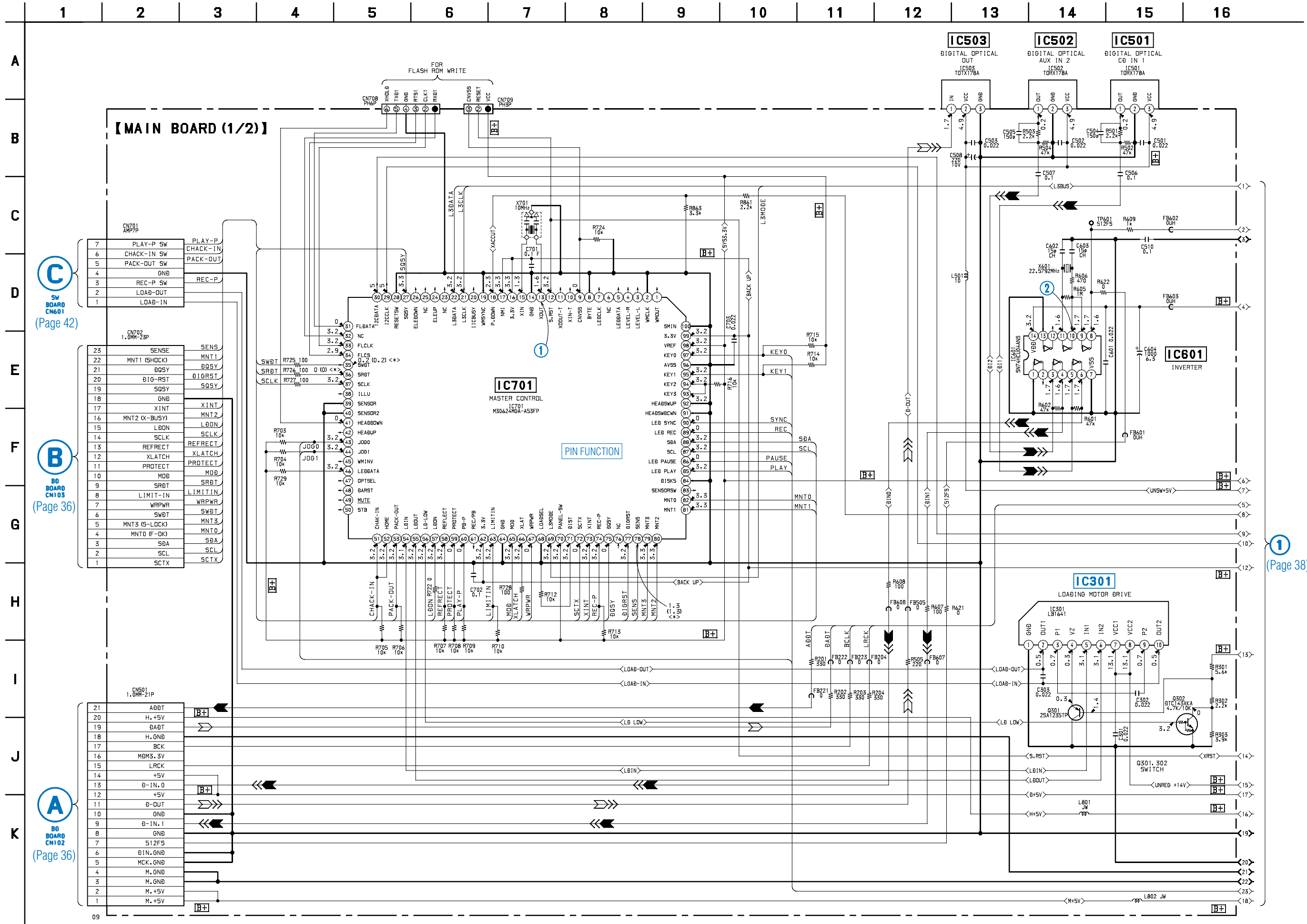

6-6. SCHEMATIC DIAGRAM – MAIN (2/2) SECTION –

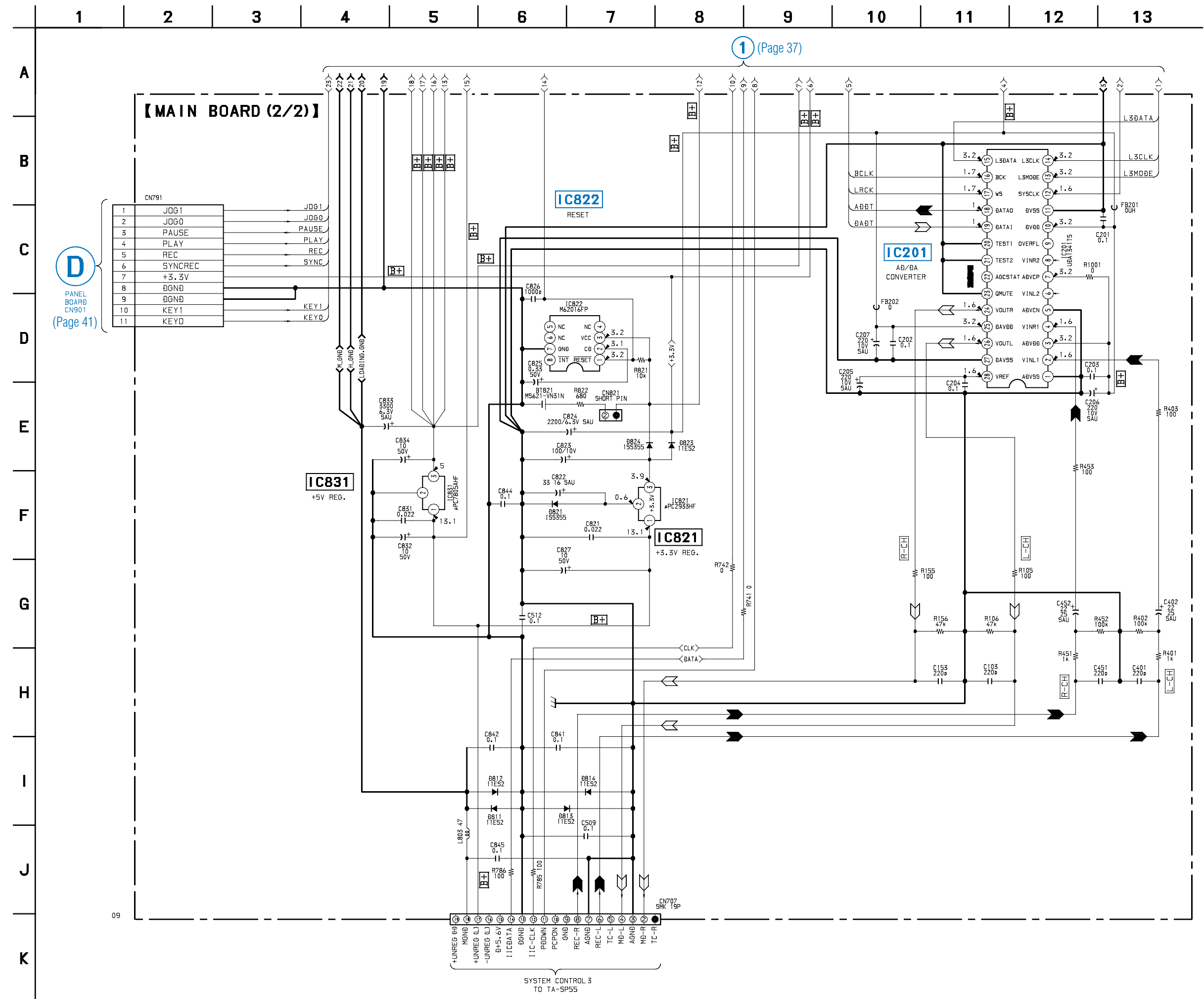

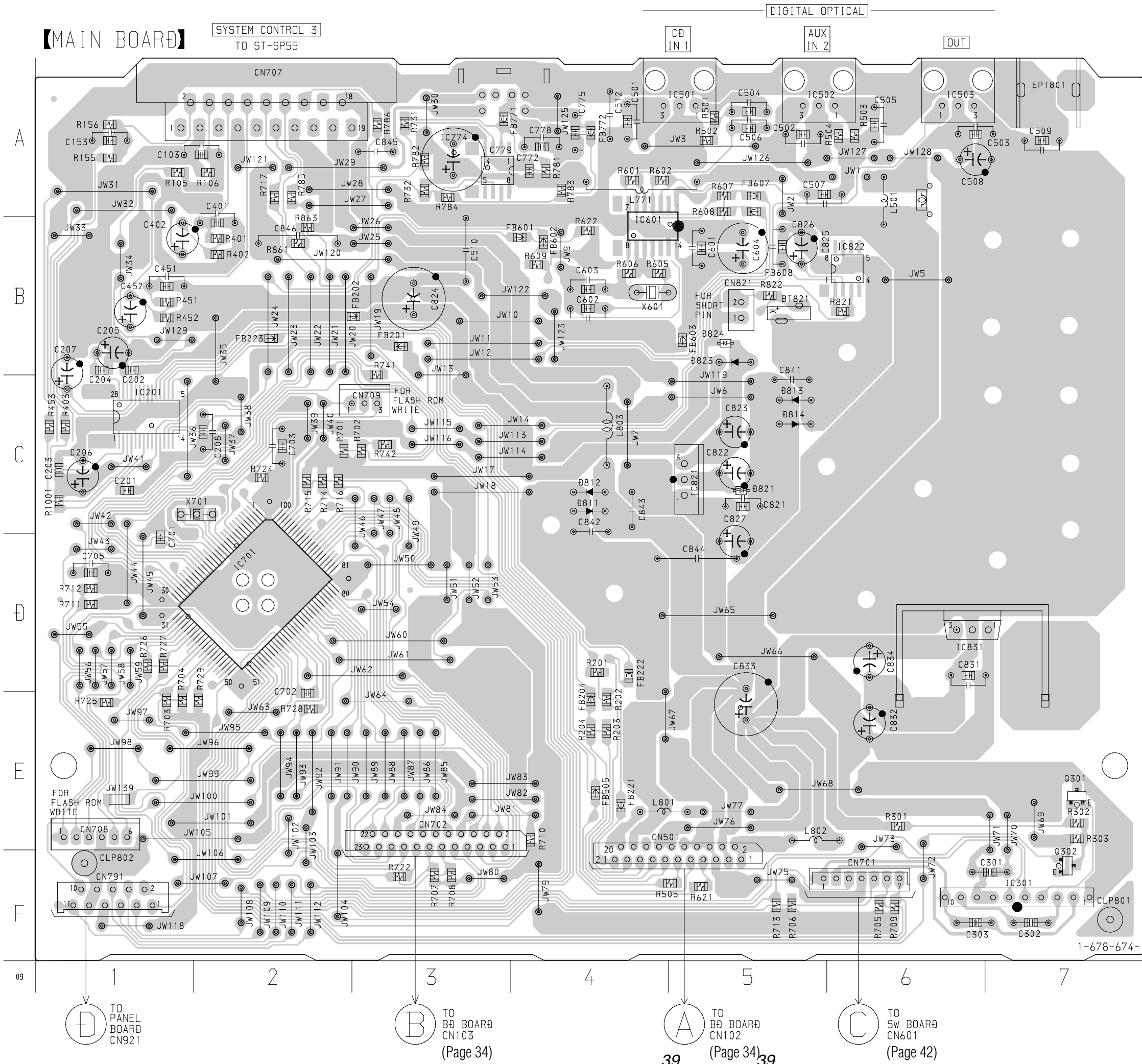

• Semiconductor Location

Ref. No.	Location
D811	C-4
D812	C-4
D813	C-5
D814	C-5
D821	C-5
D823	B-5
D824	B-5
IC201	C-1
IC301	F-7
IC501	A-5
IC502	A-5
IC503	A-6
IC601	B-4
IC701	D-2
IC821	C-5
IC822	B-6
IC831	D-6
Q301	E-7
Q302	F-7

11
(11)

There are a few cases that the part isn't mounted in model is printed on diagram.

TO PANEL BOARD
CN921

TO BD BOARD
CN103
(Page 34)

TO BD BOARD
CN102
(Page 34)

TO SW BOARD
CN601
(Page 42)

1-678-674-

6-8. PRINTED WIRING BOARD – PANEL SECTION –

【PANEL BOARD】

TO MAIN BOARD
CN791
(Page 39)

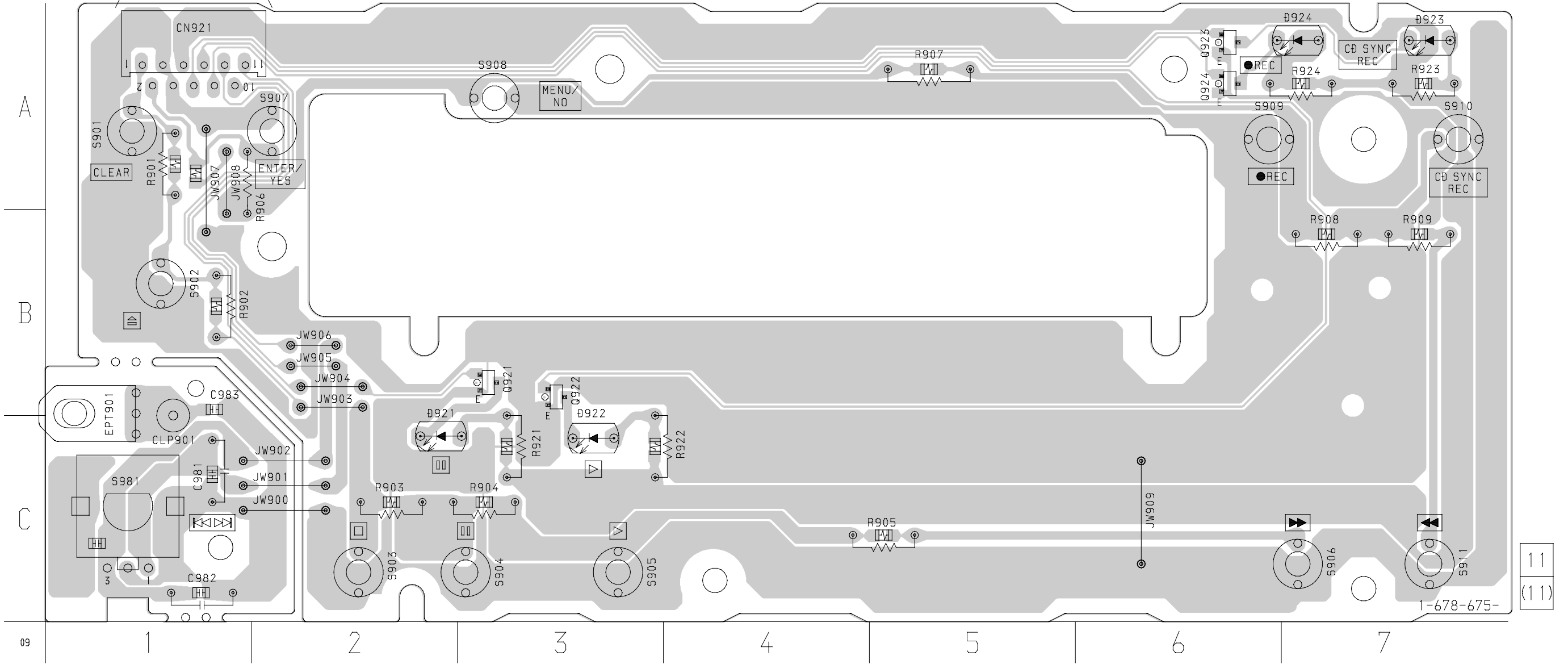

• Semiconductor Location

Ref. No.	Location
D921	C-3
D922	C-3
D923	A-7
D924	A-7
Q921	B-3
Q922	B-3
Q923	A-6
Q924	A-6

There are a few cases that the part isn't mounted in model is printed on diagram.

6-9. SCHEMATIC DIAGRAM – PANEL SECTION –

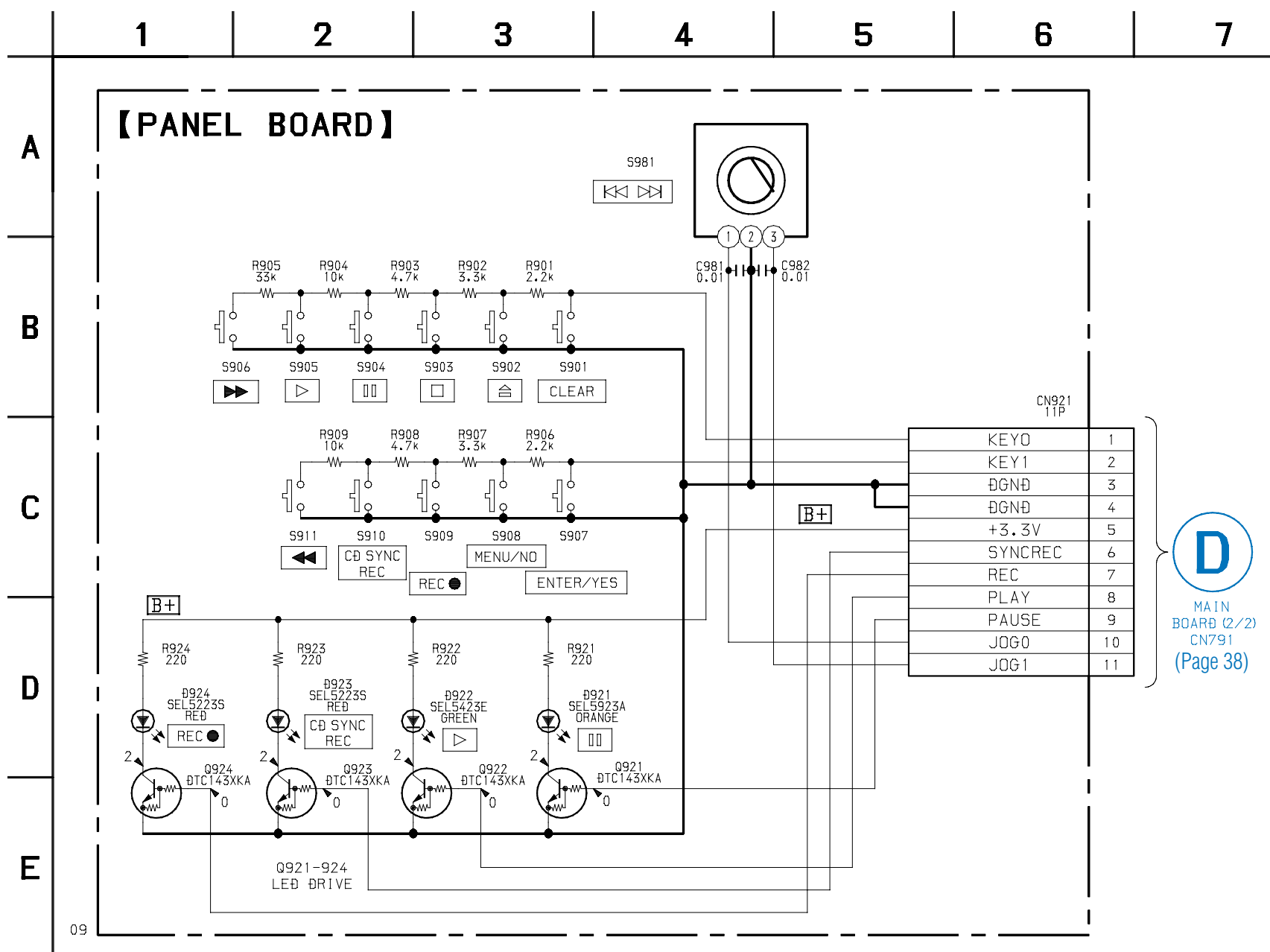

6-10. SCHEMATIC DIAGRAM – BD SWITCH SECTION –

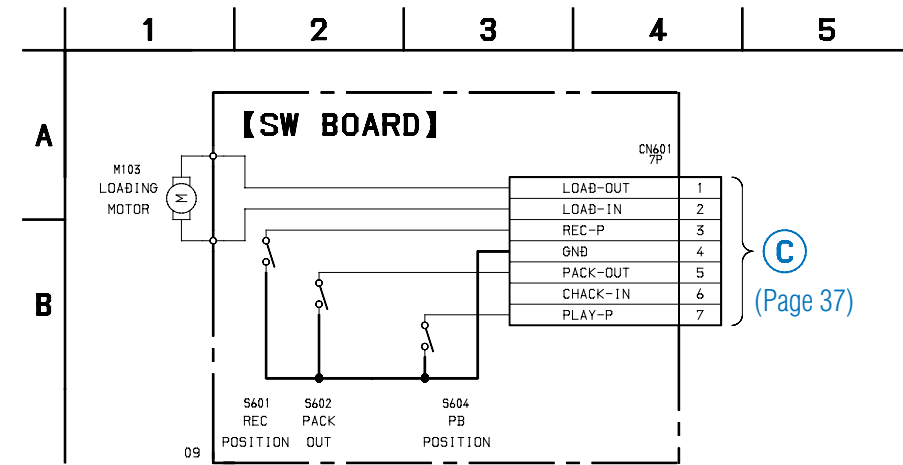

6-11. PRINTED WIRING BOARD – BD SWITCH SECTION –
• See page 28 for Circuit Boards Location.

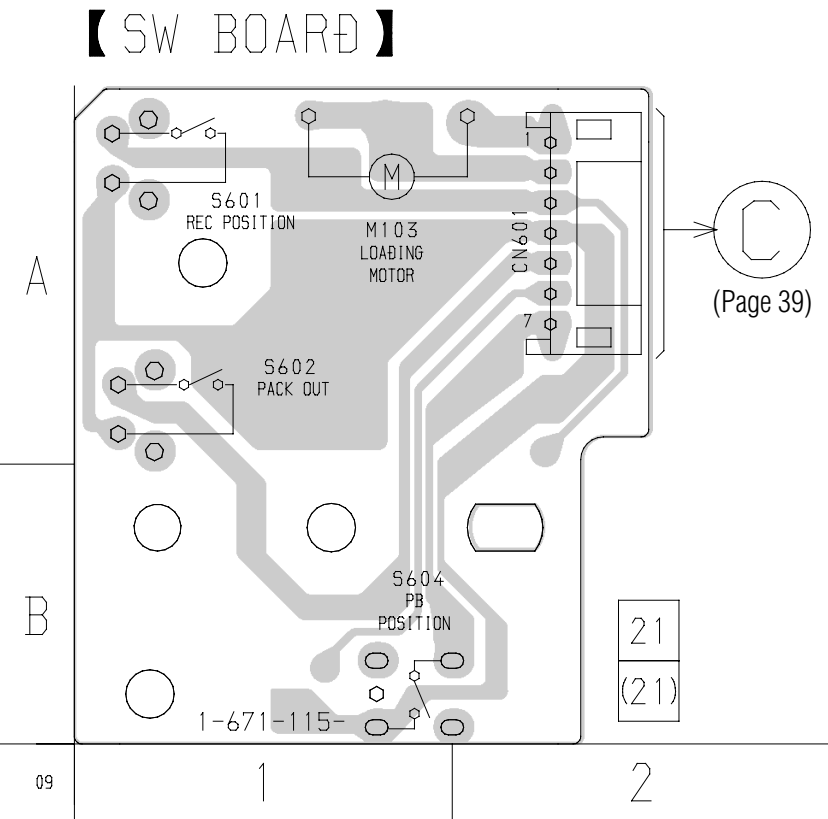

There are a few cases that the part isn't mounted in model is printed on diagram.

6-12. IC BLOCK DIAGRAMS

– BD Section –

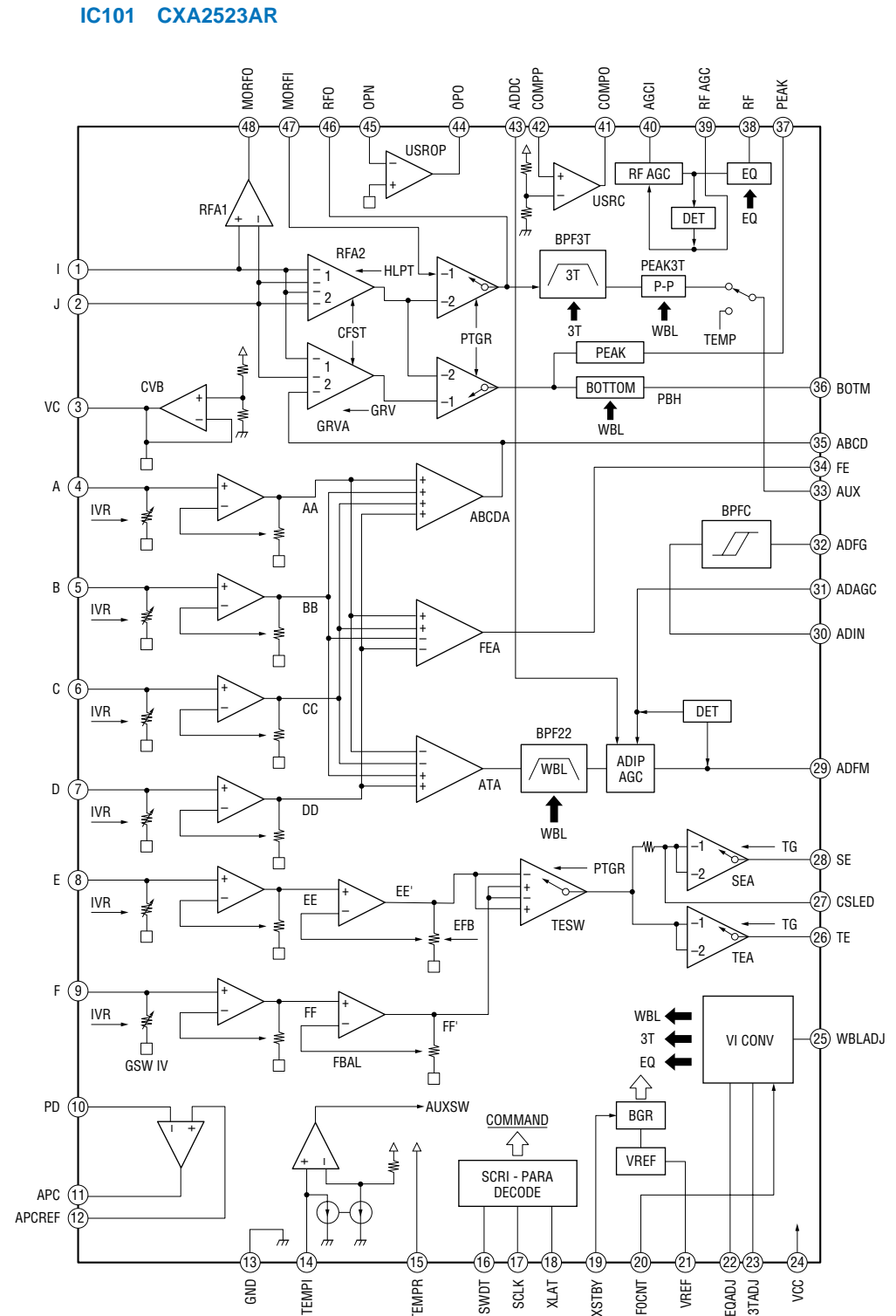

IC121 CXD2654R

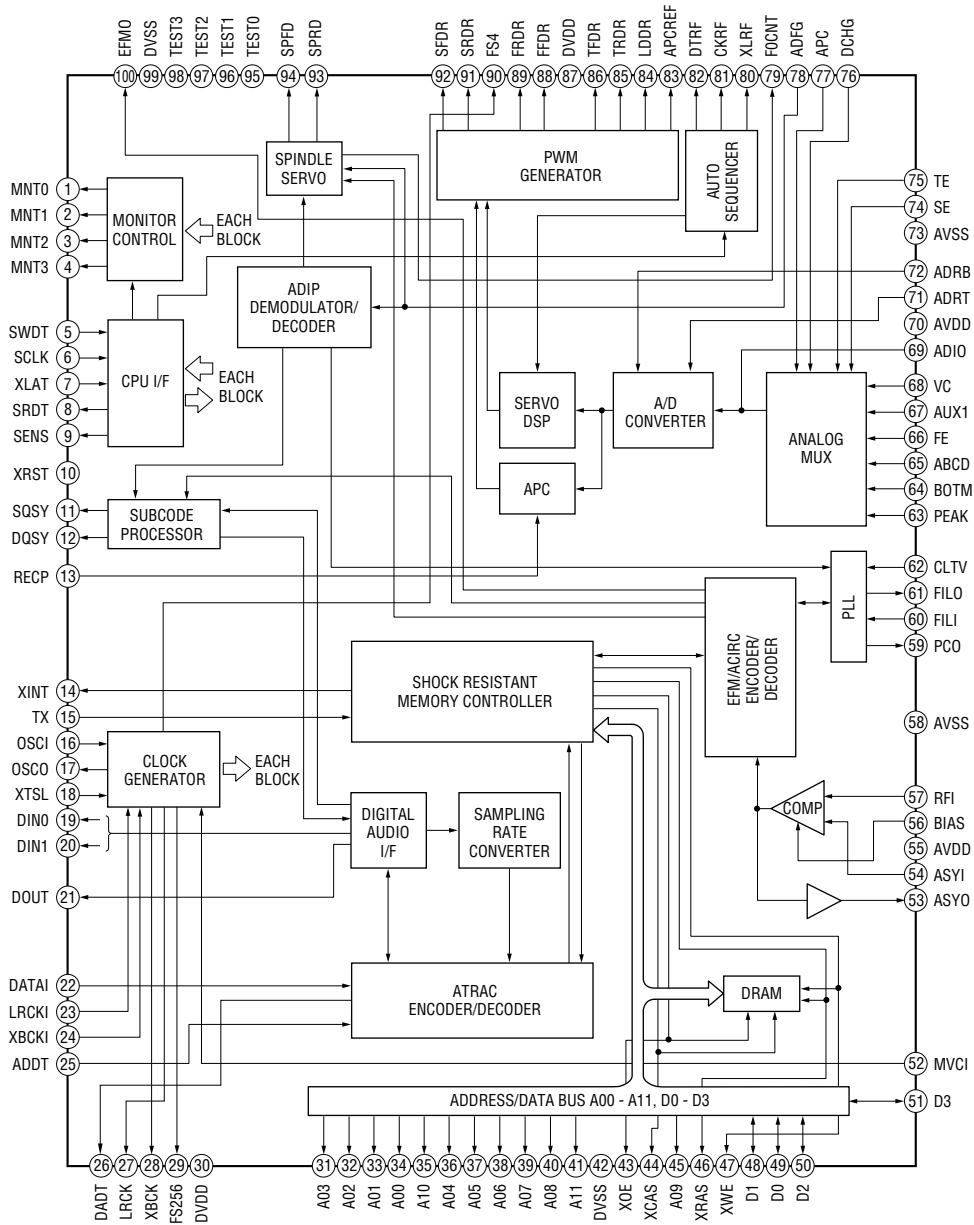

IC152 BH6511FS-E2

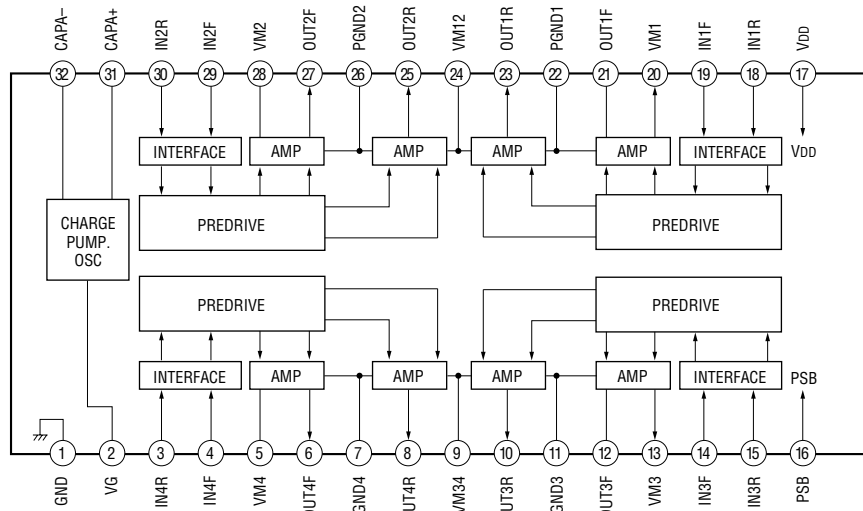

• MAIN section

IC201 UDA1341TS

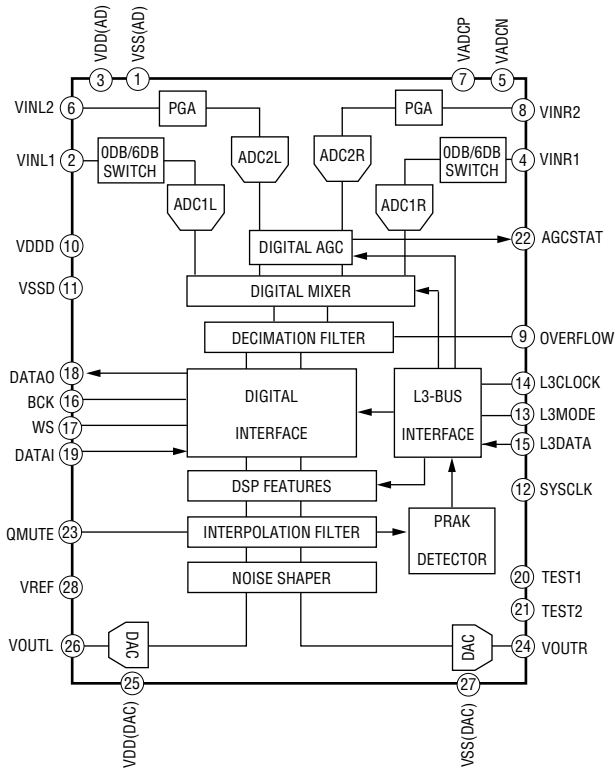

IC301 LB1641

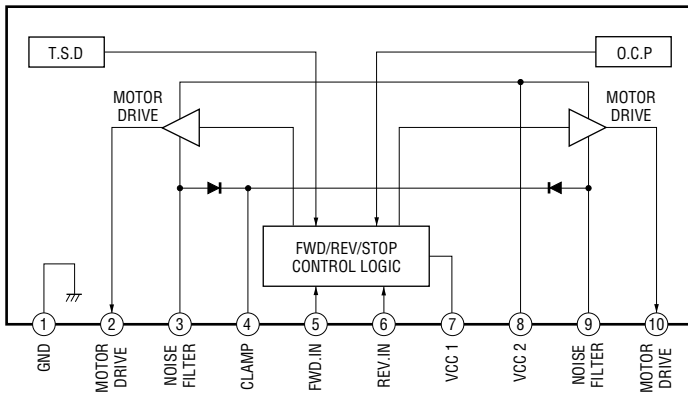

IC822 M62016FP

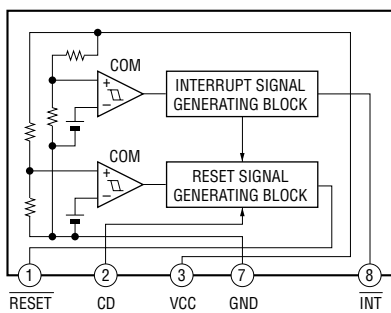

6-13. IC PIN FUNCTIONS

• IC101 RF Amplifier (CXA2523AR) (BD board)

Pin No.	Pin Name	I/O	Function
1	I	I	I-V converted RF signal I input
2	J	I	I-V converted RF signal J input
3	VC	O	Middle point voltage (+1.5V) generation output
4 to 9	A to F	I	Signal input from the optical pick-up detector
10	PD	I	Light amount monitor input
11	APC	O	Laser APC output
12	APCREF	I	Reference voltage input for setting laser power
13	GND	—	Ground
14	TEMPI	I	Temperature sensor connection
15	TEMPR	O	Reference voltage output for the temperature sensor
16	SWDT	I	Serial data input from the CXD2650R or CXD2652AR
17	SCLK	I	Serial clock input from the CXD2650R or CXD2652AR
18	XLAT	I	Latch signal input from the CXD2650R or CXD2652AR “L”: Latch
19	XSTBY	I	Stand by signal input “L”: Stand by
20	FOCNT	I	Center frequency control voltage input of BPF22, BPF3T, EQ from the CXD2650R or CXD2652AR
21	VREF	O	Reference voltage output (Not used)
22	EQADJ	I/O	Center frequency setting pin for the internal circuit EQ
23	3TADJ	I/O	Center frequency setting pin for the internal circuit BPF3T
24	Vcc	—	+3V power supply
25	WBLADJ	I/O	Center frequency setting pin for the internal circuit BPF22
26	TE	O	Tracking error signal output to the CXD2650R or CXD2652AR
27	CSLED	—	External capacitor connection pin for the sled error signal LPF
28	SE	O	Sled error signal output to the CXD2650R or CXD2652AR
29	ADFM	O	FM signal output of ADIP
30	ADIN	I	ADIP signal comparator input ADFM is connected with AC coupling
31	ADAGC	—	External capacitor connection pin for AGC of ADIP
32	ADFG	O	ADIP duplex signal output to the CXD2650R or CXD2652AR
33	AUX	O	I ₃ signal/temperature signal output to the CXD2650R or CXD2652AR (Switching with a serial command)
34	FE	O	Focus error signal output to the CXD2650R or CXD2652AR
35	ABCD	O	Light amount signal output to the CXD2650R or CXD2652AR
36	BOTM	O	RF/ABCD bottom hold signal output to the CXD2650R or CXD2652AR
37	PEAK	O	RF/ABCD peak hold signal output to the CXD2650R or CXD2652AR
38	RF	O	RF equalizer output to the CXD2650R or CXD2652AR
39	RFAGC	—	External capacitor connection pin for the RF AGC circuit
40	AGCI	I	Input to the RF AGC circuit The RF amplifier output is input with AC coupling
41	COMPO	O	User comparator output (Not used)
42	COMPP	I	User comparator input (Fixed at “L”)
43	ADDC	I/O	External capacitor pin for cutting the low band of the ADIP amplifier
44	OPO	O	User operation amplifier output (Not used)
45	OPN	I	User operation amplifier inversion input (Fixed at “L”)
46	RFO	O	RF amplifier output
47	MORFI	I	Groove RF signal is input with AC coupling
48	MORFO	O	Groove RF signal output

- Abbreviation
APC: Auto Power Control
AGC: Auto Gain Control

• IC121 Digital Signal Processor, Digital Servo Signal Processor, EFM/ACIRC Encoder/Decoder, Shock-proof Memory Controller, ATRAC Encoder/Decoder, 2M Bit DRAM (CXD2654R) (BD board)

Pin No.	Pin Name	I/O	Function
1	MNT0 (FOK)	O	FOK signal output to the system control (monitor output) “H” is output when focus is on
2	MNT1 (SHCK)	O	Track jump detection signal output to the system control (monitor output)
3	MNT2 (XBUSY)	O	Monitor 2 output to the system control (monitor output)
4	MNT3 (SLOC)	O	Monitor 3 output to the system control (monitor output)
5	SWDT	I	Writing data signal input from the system control
6	SCLK	I (S)	Serial clock signal input from the system control
7	XLAT	I (S)	Serial latch signal input from the system control
8	SRDT	O (3)	Reading data signal output to the system control
9	SENS	O (3)	Internal status (SENSE) output to the system control
10	XRST	I (S)	Reset signal input from the system control “L”: Reset
11	SQSY	O	Subcode Q sync (SCOR) output to the system control “L” is output every 13.3 msec. Almost all, “H” is output
12	DQSY	O	Digital In U-bit CD format or MD format subcode Q sync (SCOR) output to the system control
13	RECP	I	Laser power switching input from the system control “H”: Recording, “L”: Playback
14	XINT	O	Interrupt status output to the system control
15	TX	I	Recording data output enable input from the system control
16	OSCI	I	System clock input (512Fs=22.5792 MHz)
17	OSCO	O	System clock output (512Fs=22.5792 MHz) (Not used)
18	XTSL	I	System clock frequency setting “L”: 45.1584 MHz, “H”: 22.5792 MHz (Fixed at “H”)
19	DIN0	I	Digital audio input (Optical input)
20	DIN1	I	Digital audio input (Optical input)
21	DOUT	O	Digital audio output (Optical output)
22	DADTI	I	Serial data input
23	LRCKI	I	LR clock input “H” : Lch, “L” : R ch
24	XBCKI	I	Serial data clock input
25	ADDT	I	Data input from the A/D converter
26	DADT	O	Data output to the D/A converter
27	LRCK	O	LR clock output for the A/D and D/A converter (44.1 kHz)
28	XBCK	O	Bit clock output to the A/D and D/A converter (2.8224 MHz)
29	FS256	O	11.2896 MHz clock output (Not used)
30	DVDD	—	+3V power supply (Digital)
31 to 34	A03 to A00	O	DRAM address output
35	A10	O	DRAM address output (Not used)
36 to 40	A04 to A08	O	DRAM address output
41	A11	O	DRAM address output (Not used)
42	DVSS	—	Ground (Digital)
43	XOE	O	Output enable output for DRAM
44	XCAS	O	$\overline{\text{CAS}}$ signal output for DRAM
45	A09	O	Address output for DRAM
46	XRAS	O	$\overline{\text{RAS}}$ signal output for DRAM
47	XWE	O	Write enable signal output for DRAM (Used : CXD2652AR, Not used : CXD2650R)
48	D1	I/O	Data input/output for DRAM
49	D0	I/O	
50, 51	D2, D3	I/O	

* I (S) stands for Schmidt input, I (A) for analog input, O (3) for 3-state output, and O (A) for analog output in the column I/O

Pin No.	Pin Name	I/O	Function
52	MVCI	I (S)	Clock input from an external VCO (Fixed at "L")
53	ASYO	O	Playback EFM duplex signal output
54	ASYI	I (A)	Playback EFM comparator slice level input
55	AVDD	—	+3V power supply (Analog)
56	BIAS	I (A)	Playback EFM comparator bias current input
57	RFI	I (A)	Playback EFM RF signal input
58	AVSS	—	Ground (Analog)
59	PCO	O (3)	Phase comparison output for the recording/playback EFM master PLL
60	FILI	I (A)	Filter input for the recording/playback EFM master PLL
61	FILO	O (A)	Filter output for the recording/playback EFM master PLL
62	CLTV	I (A)	Internal VCO control voltage input for the recording/playback EFM master PLL
63	PEAK	I (A)	Light amount signal peak hold input from the CXA2523R
64	BOTM	I (A)	Light amount signal bottom hold input from the CXA2523R
65	ABCD	I (A)	Light amount signal input from the CXA2523R
66	FE	I (A)	Focus error signal input from the CXA2523R
67	AUX1	I (A)	Auxiliary A/D input
68	VC	I (A)	Middle point voltage (+1.5V) input from the CXA2523R
69	ADIO	O (A)	Monitor output of the A/D converter input signal (Not used)
70	AVDD	—	+3V power supply (Analog)
71	ADRT	I (A)	A/D converter operational range upper limit voltage input (Fixed at "H")
72	ADRB	I (A)	A/D converter operational range lower limit voltage input (Fixed at "L")
73	AVSS	—	Ground (Analog)
74	SE	I (A)	Sled error signal input from the CXA2523R
75	TE	I (A)	Tracking error signal input from the CXA2523R
76	DCHG	I (A)	Connected to +3V power supply
77	APC	I (A)	Error signal input for the laser digital APC (Fixed at "L")
78	ADFG	I (S)	ADIP duplex FM signal input from the CXA2523R (22.05 ± 1 kHz)
79	FOCNT	O	Filter f ₀ control output to the CXA2523R
80	XLRF	O	Control latch output to the CXA2523R
81	CKRF	O	Control clock output to the CXA2523R
82	DTRF	O	Control data output to the CXA2523R
83	APCREF	O	Reference PWM output for the laser APC
84	TEST0	O	PWM output for the laser digital APC (Not used)
85	TRDR	O	Tracking servo drive PWM output (-)
86	TFDR	O	Tracking servo drive PWM output (+)
87	DVDD	—	+3V power supply (Digital)
88	FFDR	O	Focus servo drive PWM output (+)
89	FRDR	O	Focus servo drive PWM output (-)
90	FS4	O	176.4 kHz clock signal output (X'tal) (Not used)
91	SRDR	O	Sled servo drive PWM output (-)
92	SFDR	O	Sled servo drive PWM output (+)
93	SPRD	O	Spindle servo drive PWM output (-)
94	SPFD	O	Spindle servo drive PWM output (+)
95	FGIN	I (S)	Test input (Fixed at "L")
96 to 98	TEST1 to TEST3	I	
99	DVSS	—	Ground (Digital)
100	EFMO	O	EFM output when recording

- Abbreviation
EFM: Eight to Fourteen Modulation
PLL : Phase Locked Loop
VCO: Voltage Controlled Oscillator

• IC701 M30624MGA-A53FP MASTER CONTROL (MAIN BOARD)

Pin No.	Pin Name	I/O	Function
1	WMOUT	O	MD WM LINK data out (Not used)
2	WMCLK	I	MD WM LINK clock in (Fixed at "L")
3	LEVEL-L	O	LEVEL-L DA output (Not used)
4	LEVEL-R	O	LEVEL-R DA output (Not used)
5	LEDDATA	O	LED DRIVER DATA output (Not used)
6	NC	O	Not used
7	LEDCLK	O	LED DRIVER CLOCK output (Not used)
8	BYTE	I	Data bus switching (Fixed at "L")
9	CNVSS	I	Pulled down to "L"
10	XIN-T	I	Not used
11	XOUT-T	O	
12	S.RST	I	System reset
13	XOUT	O	Main clock output (10 MHz)
14	GND	—	Ground pin
15	XIN	I	Main clock output (10 MHz)
16	3.3V	—	Power supply 3.3V
17	NMI	I	Not used (Fixed at "H")
18	P.DOWN	I	Power down detection
19	WMSYNC	I	MD WM LINK SYNC input (Fixed at "L")
20	IICBUSY	O	I ² C BUSY output (Not used)
21	L3CLK	O	AD/DA converter (IC201) clock out
22	L3DATA	O	AD/DA converter (IC201) data out
23	NC	O	Not used
24	ELEUP	O	Elevator control up output (Not used)
25	NC	O	Not used
26	ELEDOWN	O	Elevator control down output (Not used)
27	SQSY	I	SUBQ, ADIP sync input
28	RESETSW	I	Reset switch detection signal
29	IICCLK	I/O	I ² C clock
30	IICDATA	I/O	I ² C data
31	FLDATA	O	FLD transmission data out (Not used)
32	NC	O	Not used
33	FLCLK	O	FLD transmission data clock out (Not used)
34	FLCS	O	FLD transmission data chip select out (Not used)
35	SWDT	O	Serial data out
36	SRDT	I	Serial data in
37	SCLK	O	Serial clock out
38	ILLU	O	Illumination output ("H": Light up) (Not used)
39	SENSOR	I	Main sensor detection signal (Front panel open detection "H": OPEN) (Fixed at "L")
40	SENSOR2	I	Sub sensor detection signal (Fixed at "L")
41	HEADDOWN	O	Recording head control down output (Not used)
42	HEADUP	O	Recording head control up output (Not used)
43	JOG0	I	Jog 0 input
44	JOG1	I	Jog 1 input
45	WMINV	O	MD WM LINK clock inverse signal output (Not used)
46	LEDLATCH	O	LED driver latch output
47	OPTSEL1	O	Optical input selection signal output (Not used)
48	DARST	O	A/D, D/A reset signal output (Not used)
49	MUTE	O	Line mute ("L": MUTE) (Not used)
50	STB	O	Power on/off output ("H": POW ON) (Not used)

Pin No.	Pin Name	I/O	Function
51	CHAK-IN	I	Detection signal from chucking-in switch
52	HOME	I	Detection signal from HOME switch (Fixed at "L")
53	PACK-OUT	I	Detection signal from loading out (Loading out position: "L", others: "H") switch
54	LDIN	O	Loading motor in control
55	LDOUT	O	Loading motor out control
56	LD-LOW	O	Loading motor voltage control output (Low voltage: "H")
57	LDON	O	Laser power ON/OFF control output ("H": Laser ON)
58	REFLECT	I	Disc reflection rate detection (Disc with low reflection rate "H")
59	PROTECT	I	Disc hole detection (Protect: "H")
60	PB-P	I	Detection signal from playback position detection switch
61	REC/PB	O	Not used
62	3.3V	—	Power supply 3.3V
63	LIMITIN	I	Detection signal from limit switch (Sled limit in: "L")
64	GND	—	Ground pin
65	MOD	O	High frequency superimposing ON/OFF output
66	XLAT	O	Latch signal output to serial pulse
67	WRPWR	O	BD write power ON/OFF output
68	LOADINGSEL	I	LOADING SELECT input (Fixed at "L")
69	L3MODE	I	AD/DA converter (IC201) signal output
70	MODEL	I	Model selection (Fixed at "H")
71	DIST	I	Destination selection (Fixed at "H")
72	SCTX	O	Timing for sending write data to CXD2654
73	XINT	I	CXD2654 interrupt status input
74	REC-P	I	Detection signal from recording position detection switch
75	DQSY	I	Digital in sync input
76	NC	O	Not used
77	DIGRST	O	CXD2654, motor driver reset signal
78	SENS	I	Internal status
79	MNT3	I	Spindle servo lock status monitor
80	MNT2	I	Command execution status monitor
81	MNT1	I	Track jump signal
82	MNT0	I	Focus OK signal
83	SENSORSW	O	MAIN SENSOR waveform switching output (Not used)
84	DISK5	I	DISC5 IN SW (Not used)
85	LED PLAY	O	LED drive signal output (PLAY)
86	LED PAUSE	O	LED drive signal output (PAUSE)
87	SCL	O	Clock signal to backup memory
88	SDA	I/O	Data signal to backup memory
89	LED SYNC	O	LED drive signal output (SYNC)
90	LED REC	O	LED drive signal output (REC)
91	HEADSWDWN	I	Recording head down detection signal
92	DEADSWUP	I	Recording head up detection signal
93	KEY3	I	Key 3 (A/D) (Fixed at "L")
94	KEY2	I	Key 2 (A/D) (Fixed at "L")
95	KEY1	I	Key1 (A/D)
96	AVSS	—	Ground pin
97	KEY0	I	Key 0 (A/D)
98	VREF	—	A/D reference voltage 3.3V
99	3.3V	—	Power supply 3.3V
100	WMCLK	I	MD WM LINK data input (Fixed at "L")

SECTION 7 EXPLODED VIEWS

NOTE:

- -XX and -X mean standardized parts, so they may have some difference from the original one.
- Color Indication of Appearance Parts
Example:
KNOB, BALANCE (WHITE) . . . (RED)
 ↑ ↑
 Parts Color Cabinet's Color

- Items marked “*” are not stocked since they are seldom required for routine service. Some delay should be anticipated when ordering these items.
- The mechanical parts with no reference number in the exploded views are not supplied.
- Hardware (# mark) list is given in the last of the electrical parts list.

The components identified by mark \triangle or dotted line with mark \triangle are critical for safety. Replace only with part number specified.

- Abbreviation
AED : North European model
MY : Malaysia model
SP : Singapore model
HK : Hong kong model
KR : Korea model

7-1. CASE AND FRONT PANEL SECTION

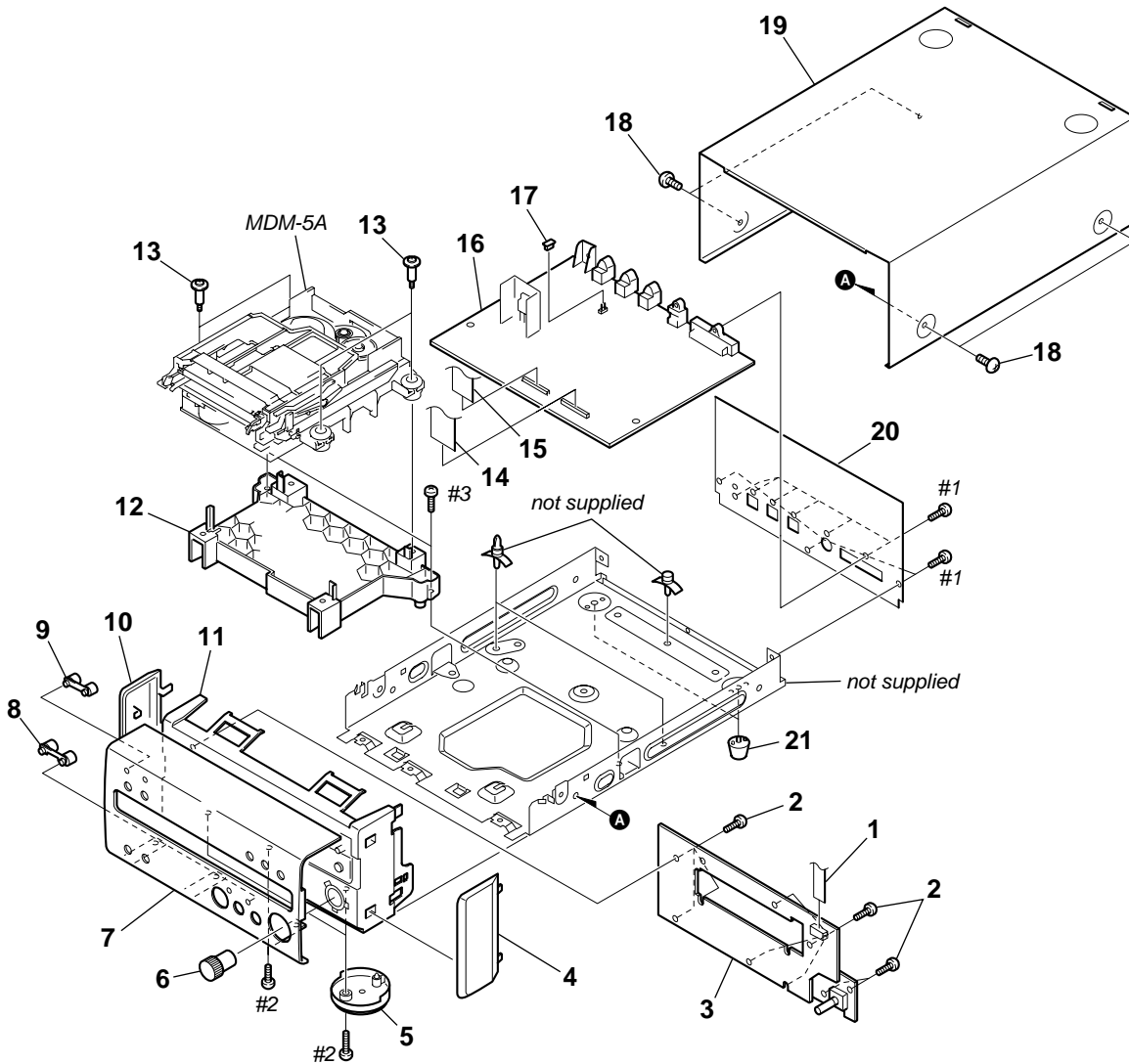

Ref. No.	Part No.	Description	Remark	Ref. No.	Part No.	Description	Remark
1	1-590-218-11	WIRE (FLAT TYPE) (11 CORE)		13	4-212-589-01	SCREW (+BVTPWH M3), STEP	
2	4-951-620-01	SCREW (2.6X8), +BVTP		14	1-783-140-11	WIRE (FLAT TYPE) (23 CORE)	
3	1-678-675-11	PANEL BOARD		15	1-783-139-11	WIRE (FLAT TYPE) (21 CORE)	
4	4-229-703-01	PLATE (R), SIDE		16	A-4725-290-A	MAIN BOARD, COMPLETE	
5	X-4953-027-1	FOOT ASSY		17	1-569-972-21	SOCKET, SHORT 2P	
6	4-229-664-01	KNOB (AMS)		18	3-363-099-51	SCREW (CASE 3 TP2)	
7	4-229-655-01	PANEL (MD), FRONT		19	4-229-701-31	CASE	
8	4-229-652-11	INDICATOR (PLAY)		20	4-229-665-01	PANEL, BACK (AEP,UK,AED)	
9	4-229-651-01	INDICATOR (REC)		20	4-229-665-21	PANEL, BACK (MY,SP,HK)	
10	4-229-704-01	PLATE (L), SIDE		20	4-229-665-31	PANEL, BACK (KR)	
11	X-4953-026-1	PANEL ASSY, SUB		21	4-965-822-01	FOOT	
12	4-229-661-01	HOLDER (MD)					

7-2. MECHANISM DECK SECTION (MDM-5A)

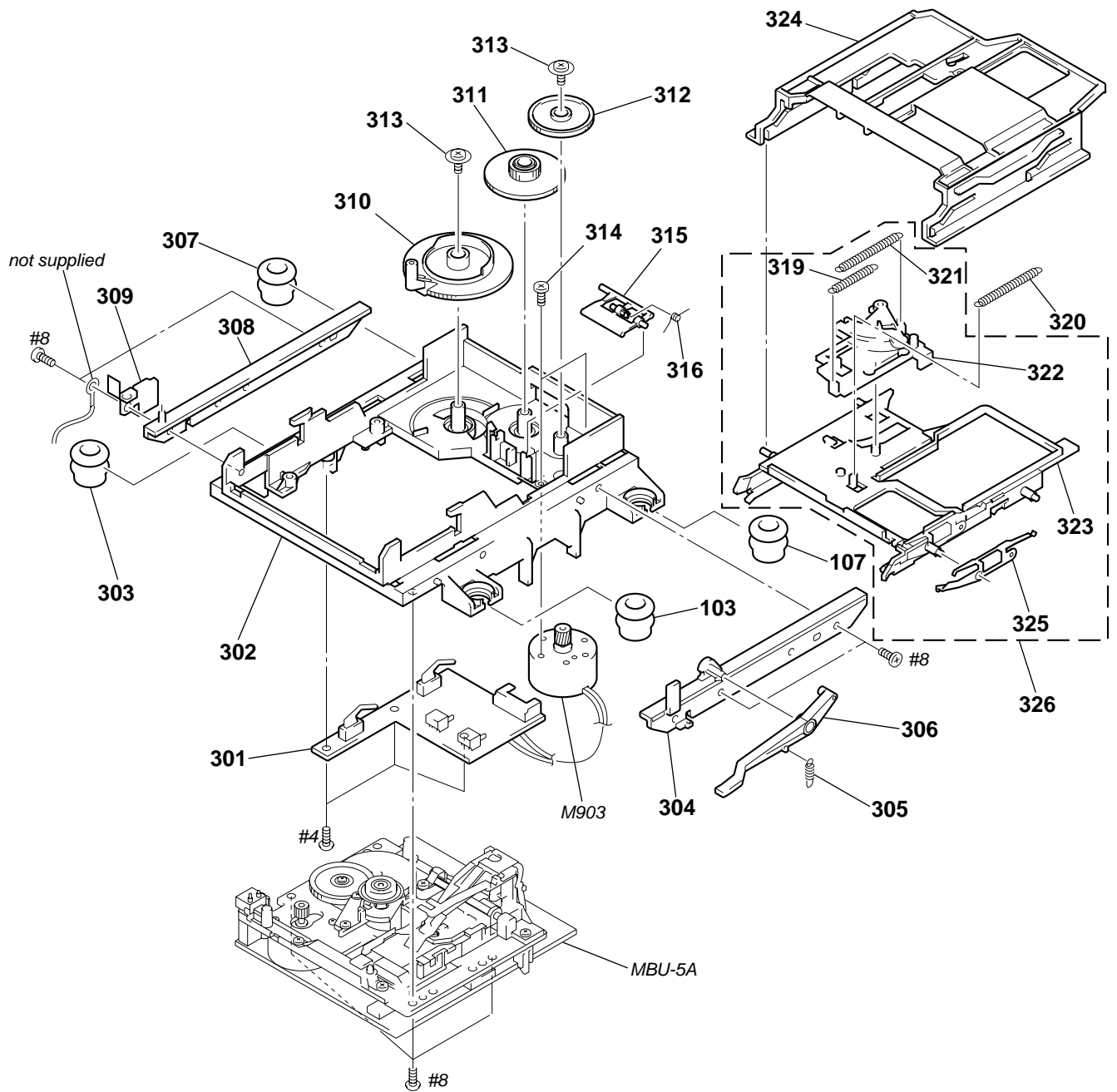

Ref. No.	Part No.	Description	Remark	Ref. No.	Part No.	Description	Remark
* 301	1-671-115-21	SW BOARD		314	4-996-224-01	SCREW (1.7X3), +PWH	
* 302	4-996-217-01	CHASSIS		315	4-996-227-14	LEVER (HEAD)	
303	4-996-223-11	INSULATOR (F)		316	4-996-229-01	SPRING (HEAD LEVER), TORSION	
* 304	4-996-218-01	BRACKET (GUIDE R)		319	4-996-214-01	SPRING (SLIDER), TENSION	
305	4-996-277-01	SPRING (O/C), TENSION		320	4-996-216-01	SPRING (HOLER), TENSION	
306	4-996-226-01	LEVER (O/C)		321	4-996-215-11	SPRING (LOCK LEVER), TENSION	
307	4-999-347-01	INSULATOR (R)		322	X-4949-668-3	SLIDER ASSY	
* 308	4-996-225-01	BRACKET (GUIDE L)		323	X-4949-667-4	HOLDER ASSY	
309	4-988-466-11	SPRING (ELECTROSTATIC), LEAF		* 324	4-996-211-11	SLIDER (CAM)	
310	4-996-219-01	GEAR (CAM GEAR)		325	4-998-763-14	SPRING (SHUTTER), LEAF	
311	4-996-220-01	GEAR (A)		326	A-4680-200-G	HOLDER COMPLETE ASSY	
312	4-996-221-01	GEAR (B)		M903	X-4949-264-1	MOTOR ASSY, LOADING	
313	4-933-134-01	SCREW (+PTPWH M2.6X6)					

7-3. BASE UNIT SECTION (MBU-5A)

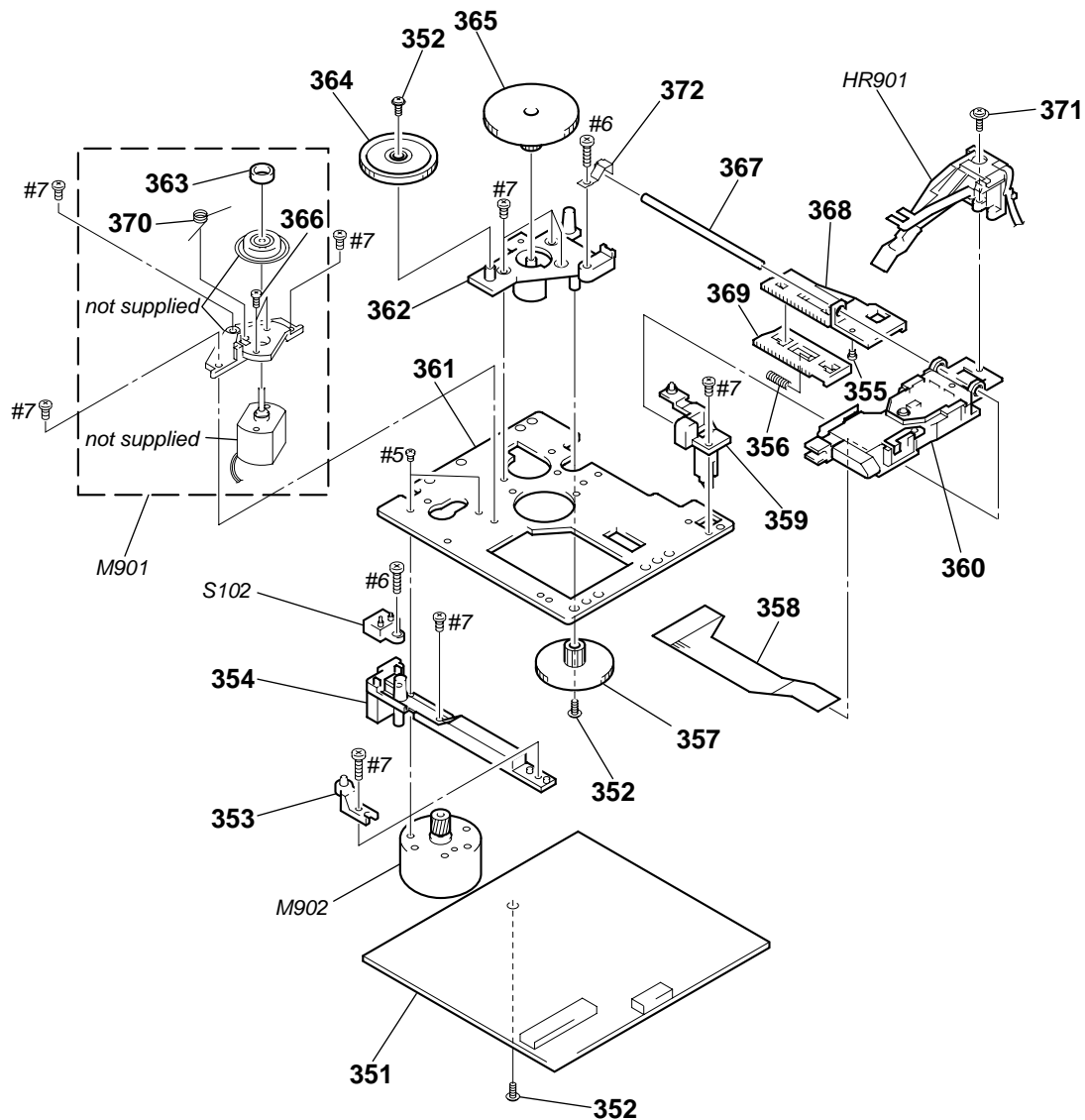

Ref. No.	Part No.	Description	Remark	Ref. No.	Part No.	Description	Remark
351	A-469-989-3A	BD BOARD, COMPLETE		365	4-996-261-01	GEAR (SL-B)	
352	3-372-761-01	SCREW (M1.7), TAPPING		366	4-211-036-01	SCREW (1.7X2.5), +PWH	
* 353	4-996-267-01	BASE (BU-D)		367	4-996-265-01	SHAFT, MAIN	
* 354	4-996-255-01	BASE (BU-C)		368	4-996-256-11	SL (BASE)	
355	4-900-590-01	SCREW, PRECISION SMALL		369	4-996-257-01	RACK (SL)	
356	4-996-258-01	SPRING, COMPRESSION		370	4-996-263-01	SPRING (CLV), TORSION	
357	4-996-262-01	GEAR (SL-C)		371	4-988-560-01	SCREW (+P 1.7X6)	
* 358	1-667-954-11	FLEXIBLE BOARD		372	4-996-264-01	SPRING (SHAFT), LEAF	
* 359	4-210-664-11	BASE (BU-A)		HR901	1-500-502-11	HEAD, OVER LIGHT	
△ 360	A-4672-541-A	OPTICAL PICK-UP KMS-260B/S1NP		M901	A-4672-475-A	MOTOR ASSY, SPINDLE	
* 361	4-996-252-01	CHASSIS, BU		M902	A-4672-474-A	MOTOR ASSY, SLED	
* 362	4-996-254-01	BASE (BU-B)		S901	1-762-148-21	SWITCH, PUSH (2 KEY) (REFLECT/PROTECT)	
363	4-967-688-11	MAGNET, ABSORPTION			4-996-215-11	SPRING (LOCK LEVER), TENSION	
363	4-967-688-21	MAGNET, ABSORPTION					
364	4-996-260-01	GEAR (SL-A)					

SECTION 8 ELECTRICAL PARTS LIST

BD

NOTE:

- Due to standardization, replacements in the parts list may be different from the parts specified in the diagrams or the components used on the set.
- -XX and -X mean standardized parts, so they may have some difference from the original one.
- RESISTORS
All resistors are in ohms.
METAL: Metal-film resistor.
METAL OXIDE: Metal oxide-film resistor.
F: nonflammable

- Items marked “*” are not stocked since they are seldom required for routine service. Some delay should be anticipated when ordering these items.
- SEMICONDUCTORS
In each case, u: μ , for example:
uA. . . : μ A. . . uPA. . . : μ PA. . .
uPB. . . : μ PB. . . uPC. . . : μ PC. . .
uPD. . . : μ PD. . .
- CAPACITORS
uF: μ F
- COILS
uH: μ H

The components identified by mark Δ or dotted line with mark Δ are critical for safety. Replace only with part number specified.

When indicating parts by reference number, please include the board.

Ref. No.	Part No.	Description	Remark	Ref. No.	Part No.	Description	Remark
	A-469-989-3A	BD BOARD, COMPLETE *****		C158	1-163-019-00	CERAMIC CHIP 0.0068uF	10% 50V
		< CAPACITOR >		C160	1-104-601-11	ELECT CHIP 10uF	20% 10V
C101	1-125-822-11	TANTALUM 10uF	20% 10V	C161	1-104-601-11	ELECT CHIP 10uF	20% 10V
C102	1-163-038-11	CERAMIC CHIP 0.1uF	25V	C163	1-163-021-91	CERAMIC CHIP 0.01uF	10% 50V
C103	1-125-822-11	TANTALUM 10uF	20% 10V	C164	1-163-021-91	CERAMIC CHIP 0.01uF	10% 50V
C104	1-125-822-11	TANTALUM 10uF	20% 10V				
C105	1-163-021-91	CERAMIC CHIP 0.01uF	10% 50V	C167	1-163-038-11	CERAMIC CHIP 0.1uF	25V
				C168	1-163-038-11	CERAMIC CHIP 0.1uF	25V
C106	1-163-275-11	CERAMIC CHIP 0.001uF	5% 50V	C169	1-125-822-11	TANTALUM 10uF	20% 10V
C107	1-163-038-11	CERAMIC CHIP 0.1uF	25V	C171	1-163-038-11	CERAMIC CHIP 0.1uF	25V
C107	1-164-156-11	CERAMIC CHIP 0.1uF	25V	C181	1-104-913-11	TANTAL. CHIP 10uF	20% 16V
C108	1-163-038-11	CERAMIC CHIP 0.1uF	25V				
C109	1-163-037-11	CERAMIC CHIP 0.022uF	10% 25V	C183	1-163-038-11	CERAMIC CHIP 0.1uF	25V
				C184	1-117-970-11	ELECT CHIP 22uF	20% 10V
C111	1-164-344-11	CERAMIC CHIP 0.068uF	10% 25V	C185	1-164-611-11	CERAMIC CHIP 0.001uF	10% 500V
C112	1-163-017-00	CERAMIC CHIP 0.0047uF	5% 50V	C187	1-104-913-11	TANTAL. CHIP 10uF	20% 16V
C113	1-109-982-11	CERAMIC CHIP 1uF	10% 10V	C188	1-163-021-91	CERAMIC CHIP 0.01uF	10% 50V
C115	1-164-489-11	CERAMIC CHIP 0.22uF	10% 16V				
C116	1-163-037-11	CERAMIC CHIP 0.022uF	10% 25V	C189	1-163-989-11	CERAMIC CHIP 0.033uF	10% 25V
				C190	1-126-206-11	ELECT CHIP 100uF	20% 6.3V
C117	1-163-809-11	CERAMIC CHIP 0.047uF	10% 25V	C191	1-163-038-11	CERAMIC CHIP 0.1uF	25V
C118	1-163-038-11	CERAMIC CHIP 0.1uF	25V	C196	1-163-038-11	CERAMIC CHIP 0.1uF	25V
C119	1-125-822-11	TANTALUM 10uF	20% 10V	C197	1-163-038-11	CERAMIC CHIP 0.1uF	25V
C121	1-125-822-11	TANTALUM 10uF	20% 10V			< CONNECTOR >	
C122	1-163-021-91	CERAMIC CHIP 0.01uF	10% 50V	CN101	1-569-479-51	CONNECTOR, FPC 21P	
				CN102	1-784-833-21	CONNECTOR, FFC (LIF(NON-ZIF)) 21P	
C123	1-163-038-11	CERAMIC CHIP 0.1uF	25V	CN103	1-784-834-21	CONNECTOR, FFC (LIF(NON-ZIF)) 23P	
C124	1-163-038-11	CERAMIC CHIP 0.1uF	25V	CN104	1-770-687-11	CONNECTOR, FFC/FPC 4P	
C127	1-163-038-11	CERAMIC CHIP 0.1uF	25V	CN110	1-695-440-21	PIN, CONNECTOR (PC BOARD) 6P	
C128	1-163-021-91	CERAMIC CHIP 0.01uF	10% 50V			< DIODE >	
C129	1-107-823-11	CERAMIC CHIP 0.47uF	10% 16V	D101	8-719-988-61	DIODE 1SS355TE-17	
				D181	8-719-046-86	DIODE F1J6TP	
C130	1-163-251-11	CERAMIC CHIP 100PF	5% 50V	D183	8-719-046-86	DIODE F1J6TP	
C131	1-163-023-00	CERAMIC CHIP 0.015uF	5% 50V			< IC >	
C132	1-107-823-11	CERAMIC CHIP 0.47uF	10% 16V	IC101	8-752-080-95	IC CXA2523AR	
C133	1-163-017-00	CERAMIC CHIP 0.0047uF	5% 50V	IC103	8-729-903-10	TRANSISTOR FMW1-T-148	
C134	1-163-038-11	CERAMIC CHIP 0.1uF	25V	IC121	8-752-389-44	IC CXD2654R	
				IC123	8-759-096-87	IC TC7WU04FU (TE12R)	
C135	1-163-038-11	CERAMIC CHIP 0.1uF	25V	IC124	8-759-498-44	IC MSM51V4400-70TS-K	
C136	1-126-206-11	ELECT CHIP 100uF	20% 6.3V				
C142	1-163-251-11	CERAMIC CHIP 100PF	5% 50V	IC152	8-759-430-25	IC BH6511FS-E2	
C143	1-163-251-11	CERAMIC CHIP 100PF	5% 50V	IC171	8-759-487-04	IC BR24C02F-E2	
C144	1-163-251-11	CERAMIC CHIP 100PF	5% 50V	IC181	8-759-481-17	IC MC74ACT08DTR2	
				IC192	8-759-460-72	IC BA033FP-E2	
C146	1-163-038-11	CERAMIC CHIP 0.1uF	25V				
C151	1-126-206-11	ELECT CHIP 100uF	20% 6.3V				
C152	1-163-038-11	CERAMIC CHIP 0.1uF	25V				
C153	1-163-021-91	CERAMIC CHIP 0.01uF	10% 50V				
C156	1-163-038-11	CERAMIC CHIP 0.1uF	25V				

Ref. No.	Part No.	Description	Remark
< COIL >			
L101	1-414-813-11	FERRITE 0uH	
L102	1-414-813-11	FERRITE 0uH	
L103	1-414-813-11	FERRITE 0uH	
L105	1-414-813-11	FERRITE 0uH	
L106	1-414-813-11	FERRITE 0uH	
L121	1-414-813-11	FERRITE 0uH	
L122	1-414-813-11	FERRITE 0uH	
L151	1-412-029-11	INDUCTOR CHIP 10uH	
L152	1-412-029-11	INDUCTOR CHIP 10uH	
L153	1-412-032-11	INDUCTOR CHIP 100uH	
L154	1-412-032-11	INDUCTOR CHIP 100uH	
L161	1-414-813-11	FERRITE 0uH	
L162	1-414-813-11	FERRITE 0uH	
L181	1-216-295-11	SHORT 0	
< TRANSISTOR >			
Q101	8-729-403-35	TRANSISTOR UN5113-TX	
Q102	8-729-026-53	TRANSISTOR 2SA1576A-T106-QR	
Q103	8-729-402-93	TRANSISTOR UN5214-TX	
Q104	8-729-402-93	TRANSISTOR UN5214-TX	
Q162	8-729-101-07	TRANSISTOR 2SB798-T1DK	
Q163	8-729-403-35	TRANSISTOR UN5113-TX	
Q181	8-729-018-75	TRANSISTOR 2SJ278MYTR	
Q182	8-729-017-65	TRANSISTOR 2SK1764KYTR	
< RESISTOR >			
R103	1-216-049-11	RES-CHIP 1K 5%	1/10W
R104	1-216-073-00	METAL CHIP 10K 5%	1/10W
R105	1-216-065-91	RES-CHIP 4.7K 5%	1/10W
R106	1-216-133-00	METAL CHIP 3.3M 5%	1/10W
R107	1-216-113-00	METAL CHIP 470K 5%	1/10W
R109	1-216-295-11	SHORT 0	
R110	1-216-073-00	METAL CHIP 10K 5%	1/10W
R111	1-216-295-11	SHORT 0	
R112	1-216-089-11	RES-CHIP 47K 5%	1/10W
R113	1-216-049-11	RES-CHIP 1K 5%	1/10W
R115	1-216-049-11	RES-CHIP 1K 5%	1/10W
R117	1-216-113-00	METAL CHIP 470K 5%	1/10W
R120	1-216-025-11	RES-CHIP 100 5%	1/10W
R121	1-216-097-11	RES-CHIP 100K 5%	1/10W
R123	1-216-295-11	SHORT 0	
R124	1-216-025-11	RES-CHIP 100 5%	1/10W
R125	1-216-025-11	RES-CHIP 100 5%	1/10W
R127	1-216-025-11	RES-CHIP 100 5%	1/10W
R129	1-216-295-11	SHORT 0	
R130	1-216-295-11	SHORT 0	
R131	1-216-073-00	METAL CHIP 10K 5%	1/10W
R132	1-216-097-11	RES-CHIP 100K 5%	1/10W
R133	1-216-117-00	METAL CHIP 680K 5%	1/10W
R134	1-216-049-11	RES-CHIP 1K 5%	1/10W
R135	1-216-061-00	METAL CHIP 3.3K 5%	1/10W
R136	1-216-049-11	RES-CHIP 1K 5%	1/10W
R137	1-216-295-11	SHORT 0	
R140	1-216-029-00	METAL CHIP 150 5%	1/10W
R142	1-216-073-00	METAL CHIP 10K 5%	1/10W
R143	1-216-073-00	METAL CHIP 10K 5%	1/10W

Ref. No.	Part No.	Description	Remark
R144	1-216-025-11	RES-CHIP 100 5%	1/10W
R145	1-216-073-00	METAL CHIP 10K 5%	1/10W
R146	1-216-037-00	METAL CHIP 330 5%	1/10W
R147	1-216-025-11	RES-CHIP 100 5%	1/10W
R148	1-216-045-00	METAL CHIP 680 5%	1/10W
R149	1-216-073-00	METAL CHIP 10K 5%	1/10W
R150	1-216-295-11	SHORT 0	
R151	1-216-073-00	METAL CHIP 10K 5%	1/10W
R152	1-216-073-00	METAL CHIP 10K 5%	1/10W
R158	1-216-097-11	RES-CHIP 100K 5%	1/10W
R159	1-216-097-11	RES-CHIP 100K 5%	1/10W
R160	1-216-295-11	SHORT 0	
R161	1-216-057-00	METAL CHIP 2.2K 5%	1/10W
R162	1-216-057-00	METAL CHIP 2.2K 5%	1/10W
R163	1-216-057-00	METAL CHIP 2.2K 5%	1/10W
R164	1-216-045-00	METAL CHIP 680 5%	1/10W
R165	1-216-097-11	RES-CHIP 100K 5%	1/10W
R166	1-216-298-00	METAL CHIP 2.2 5%	1/10W
R167	1-216-065-91	RES-CHIP 4.7K 5%	1/10W
R169	1-219-724-11	METAL CHIP 1 1%	1/4W
R170	1-216-073-00	METAL CHIP 10K 5%	1/10W
R171	1-216-073-00	METAL CHIP 10K 5%	1/10W
R173	1-216-121-11	RES-CHIP 1M 5%	1/10W
R175	1-216-065-91	RES-CHIP 4.7K 5%	1/10W
R177	1-216-061-00	METAL CHIP 3.3K 5%	1/10W
R179	1-216-085-00	METAL CHIP 33K 5%	1/10W
R180	1-216-073-00	METAL CHIP 10K 5%	1/10W
R182	1-216-089-11	RES-CHIP 47K 5%	1/10W
R183	1-216-089-11	RES-CHIP 47K 5%	1/10W
R184	1-216-073-00	METAL CHIP 10K 5%	1/10W
R185	1-216-081-00	METAL CHIP 22K 5%	1/10W
R186	1-216-089-11	RES-CHIP 47K 5%	1/10W
R188	1-216-073-00	METAL CHIP 10K 5%	1/10W
R189	1-216-073-00	METAL CHIP 10K 5%	1/10W
R190	1-216-073-00	METAL CHIP 10K 5%	1/10W
R195	1-216-073-00	METAL CHIP 10K 5%	1/10W
R196	1-216-295-11	SHORT 0	
R197	1-216-295-11	SHORT 0	
R198	1-216-296-91	SHORT 0	
< SWITCH >			
S101	1-762-596-21	SWITCH, PUSH (1 KEY) (LIMIT IN)	

	A-4725-290-A	MAIN BOARD, COMPLETE	*****
	7-685-646-79	SCREW +BVTP 3X8 TYPE2 N-S	
< BATTERY >			
BT821	1-528-938-11	BATTERY, LITHIUM ION SECONDARY	
< CAPACITOR >			
C103	1-162-286-11	CERAMIC CHIP 220PF 10%	50V
C153	1-162-286-11	CERAMIC CHIP 220PF 10%	50V
C201	1-163-038-11	CERAMIC CHIP 0.1uF	25V
C202	1-163-038-11	CERAMIC CHIP 0.1uF	25V
C203	1-163-038-11	CERAMIC CHIP 0.1uF	25V

Ref. No.	Part No.	Description	Remark	Ref. No.	Part No.	Description	Remark				
C204	1-163-038-11	CERAMIC CHIP	0.1uF	25V	D813	8-719-200-82	DIODE 11ES2-TB5				
C205	1-128-832-11	ELECT	220uF	20%	10V	D814	8-719-200-82	DIODE 11ES2-TB5			
C206	1-128-832-11	ELECT	220uF	20%	10V	D821	8-719-988-61	DIODE 1SS355TE-17			
C207	1-128-832-11	ELECT	220uF	20%	10V	D823	8-719-200-82	DIODE 11ES2-TB5			
C301	1-161-494-00	CERAMIC	0.022uF	25V	D824	8-719-988-61	DIODE 1SS355TE-17				
C302	1-161-494-00	CERAMIC	0.022uF	25V	< FERRITE BEAD >						
C303	1-161-494-00	CERAMIC	0.022uF	25V	FB201	1-500-445-21	FERRITE	0UH			
C401	1-162-286-31	CERAMIC CHIP	220PF	10%	50V	FB202	1-216-295-11	SHORT	0		
C402	1-128-858-91	ELECT	22uF	20%	25V	FB204	1-216-295-11	SHORT	0		
C451	1-162-286-31	CERAMIC CHIP	220PF	10%	50V	FB221	1-216-295-11	SHORT	0		
C452	1-128-858-91	ELECT	22uF	20%	25V	FB222	1-216-295-11	SHORT	0		
C501	1-161-494-00	CERAMIC	0.022uF	25V	FB223	1-216-295-11	SHORT	0			
C502	1-161-494-00	CERAMIC	0.022uF	25V	FB505	1-216-295-11	SHORT	0			
C503	1-161-494-00	CERAMIC	0.022uF	25V	FB601	1-500-445-21	FERRITE	0UH			
C504	1-162-284-31	CERAMIC	150PF	10%	50V	FB602	1-500-445-21	FERRITE	0UH		
C505	1-162-284-31	CERAMIC	150PF	10%	50V	FB603	1-500-445-21	FERRITE	0UH		
C506	1-161-159-11	CERAMIC	0.1uF	50V	FB607	1-216-295-11	SHORT	0			
C507	1-161-159-11	CERAMIC	0.1uF	50V	FB608	1-216-295-11	SHORT	0			
C508	1-126-934-11	ELECT	220uF	20%	10V	< IC >					
C509	1-161-159-11	CERAMIC	0.1uF	50V	IC201	8-759-553-65	IC UDA1341TS				
C510	1-164-159-11	CERAMIC	0.1uF	50V	IC301	8-759-822-09	IC LB1641				
C512	1-164-159-11	CERAMIC	0.1uF	50V	IC501	8-749-923-05	IC TORX178B (DIGITAL OPTICAL CD IN1)				
C601	1-161-494-00	CERAMIC	0.022uF	25V	IC502	8-749-923-05	IC TORX178B (DIGITAL OPTICAL AUX IN2)				
C602	1-162-203-31	CERAMIC	15PF	5%	50V	IC503	8-749-923-04	IC TOTX178A (DIGITAL OPTICAL OUT)			
C603	1-162-203-31	CERAMIC	15PF	5%	50V	IC601	8-759-927-29	IC SN74HCU04ANS-E05			
C604	1-126-916-11	ELECT	1000uF	20%	6.3V	IC701	8-759-681-69	IC M30624MGA-A53FP			
C701	1-163-038-11	CERAMIC CHIP	0.1uF	25V	IC821	8-759-647-10	IC uPC2933HF				
C702	1-163-038-11	CERAMIC CHIP	0.1uF	25V	IC822	8-759-565-74	IC M62016FP-E1				
C703	1-161-494-00	CERAMIC	0.022uF	25V	IC831	8-759-039-69	IC uPC7805AHF				
C703	1-161-494-00	CERAMIC	0.022uF	25V	< JUMPER RESISTOR >						
C821	1-161-494-00	CERAMIC	0.022uF	25V	JW139	1-216-296-91	SHORT	0			
C822	1-128-839-11	ELECT MELF	33uF	20%	16V	< COIL >					
C823	1-104-665-11	ELECT	100uF	20%	10V	L501	1-410-509-11	INDUCTOR	10uH		
C824	1-104-656-11	ELECT	2200uF	20%	6.3V	L803	1-408-072-00	INDUCTOR	47uH		
C825	1-124-252-00	ELECT	0.33uF	20%	50V	< TRANSISTOR >					
C826	1-162-294-31	CERAMIC	0.001uF	10%	50V	Q301	8-729-600-22	TRANSISTOR 2SA1235TP-1EF			
C827	1-126-964-11	ELECT	10uF	20%	50V	Q302	8-729-027-57	TRANSISTOR DTC143XKA-T146			
C831	1-161-494-00	CERAMIC	0.022uF	25V	< RESISTOR >						
C832	1-126-964-11	ELECT	10uF	20%	50V	R105	1-216-025-11	RES-CHIP	100	5%	1/10W
C833	1-126-917-11	ELECT	3300uF	20%	6.3V	R106	1-216-089-11	RES-CHIP	47K	5%	1/10W
C834	1-126-964-11	ELECT	10uF	20%	50V	R155	1-216-025-11	RES-CHIP	100	5%	1/10W
C841	1-164-159-11	CERAMIC	0.1uF	50V	R156	1-216-089-11	RES-CHIP	47K	5%	1/10W	
C842	1-164-159-11	CERAMIC	0.1uF	50V	R201	1-216-037-00	METAL CHIP	330	5%	1/10W	
C844	1-164-159-11	CERAMIC	0.1uF	50V	R202	1-216-037-00	METAL CHIP	330	5%	1/10W	
C845	1-164-159-11	CERAMIC	0.1uF	50V	R203	1-216-037-00	METAL CHIP	330	5%	1/10W	
C916	1-126-916-11	ELECT	1000uF	20%	6.3V	R204	1-216-037-00	METAL CHIP	330	5%	1/10W
< CONNECTOR >				R301	1-216-067-00	METAL CHIP	5.6K	5%	1/10W		
CN501	1-784-418-11	CONNECTOR, FFC (LIF(NON-ZIF) 21P		R302	1-216-057-00	METAL CHIP	2.2K	5%	1/10W		
* CN701	1-568-934-11	PIN, CONNECTOR 7P		R303	1-216-063-91	RES-CHIP	3.9K	5%	1/10W		
CN702	1-784-417-11	CONNECTOR, FFC (LIF(NON-ZIF) 23P		R401	1-216-049-11	RES-CHIP	1K	5%	1/10W		
CN707	1-793-351-21	SOCKET, CONNECTOR 19P		R402	1-216-097-11	RES-CHIP	100K	5%	1/10W		
* CN708	1-564-708-11	PIN, CONNECTOR (SMALL TYPE) 6P		R403	1-216-025-11	RES-CHIP	100	5%	1/10W		
* CN709	1-564-705-11	PIN, CONNECTOR (SMALL TYPE) 3P		R451	1-216-049-11	RES-CHIP	1K	5%	1/10W		
CN791	1-568-830-11	CONNECTOR, FFC 11P		< DIODE >							
CN821	1-568-683-11	PIN, CONNECTOR (PC BAORD) 2P		D811	8-719-200-82	DIODE 11ES2-TB5					
< DIODE >				D812	8-719-200-82	DIODE 11ES2-TB5					

Ref. No.	Part No.	Description	Remark
R452	1-216-097-11	RES-CHIP 100K	5% 1/10W
R453	1-216-025-11	RES-CHIP 100	5% 1/10W
R501	1-216-057-00	METAL CHIP 2.2K	5% 1/10W
R502	1-216-089-11	RES-CHIP 47K	5% 1/10W
R503	1-216-057-00	METAL CHIP 2.2K	5% 1/10W
R504	1-216-089-11	RES-CHIP 47K	5% 1/10W
R505	1-216-033-00	METAL CHIP 220	5% 1/10W
R601	1-216-089-11	RES-CHIP 47K	5% 1/10W
R602	1-216-089-11	RES-CHIP 47K	5% 1/10W
R605	1-216-121-11	RES-CHIP 1M	5% 1/10W
R606	1-216-041-00	METAL CHIP 470	5% 1/10W
R607	1-216-025-11	RES-CHIP 100	5% 1/10W
R608	1-216-025-11	RES-CHIP 100	5% 1/10W
R609	1-216-049-11	RES-CHIP 1K	5% 1/10W
R621	1-216-295-11	SHORT 0	
R622	1-216-295-11	SHORT 0	
R703	1-216-073-00	METAL CHIP 10K	5% 1/10W
R704	1-216-073-00	METAL CHIP 10K	5% 1/10W
R705	1-216-073-00	METAL CHIP 10K	5% 1/10W
R706	1-216-073-00	METAL CHIP 10K	5% 1/10W
R707	1-216-073-00	METAL CHIP 10K	5% 1/10W
R708	1-216-073-00	METAL CHIP 10K	5% 1/10W
R709	1-216-073-00	METAL CHIP 10K	5% 1/10W
R710	1-216-073-00	METAL CHIP 10K	5% 1/10W
R712	1-216-073-00	METAL CHIP 10K	5% 1/10W
R713	1-216-073-00	METAL CHIP 10K	5% 1/10W
R714	1-216-073-00	METAL CHIP 10K	5% 1/10W
R715	1-216-073-00	METAL CHIP 10K	5% 1/10W
R716	1-216-073-00	METAL CHIP 10K	5% 1/10W
R722	1-216-295-11	SHORT 0	
R724	1-216-073-00	METAL CHIP 10K	5% 1/10W
R725	1-216-025-11	RES-CHIP 100	5% 1/10W
R726	1-216-025-11	RES-CHIP 100	5% 1/10W
R727	1-216-025-11	RES-CHIP 100	5% 1/10W
R728	1-216-025-11	RES-CHIP 100	5% 1/10W
R729	1-216-073-00	METAL CHIP 10K	5% 1/10W
R741	1-216-295-11	SHORT 0	
R742	1-216-295-11	SHORT 0	
R785	1-216-025-11	RES-CHIP 100	5% 1/10W
R786	1-216-025-11	RES-CHIP 100	5% 1/10W
R821	1-216-073-00	METAL CHIP 10K	5% 1/10W
R822	1-216-045-00	METAL CHIP 680	5% 1/10W
R861	1-216-057-00	METAL CHIP 2.2k	5% 1/10W
R863	1-216-061-00	METAL CHIP 3.3k	5% 1/10W
R1001	1-216-295-11	SHORT 0	
< VIBRATOR >			
X601	1-579-314-11	VIBRATOR, CRYSTAL (22.5792MHz)	
X701	1-579-175-11	VIBRATOR, CERAMIC (10MHz)	

1-678-675-11	PANEL BOARD	*****	
< CAPACITOR >			
C981	1-162-306-11	CERAMIC 0.01uF	20% 16V
C982	1-162-306-11	CERAMIC 0.01uF	20% 16V

Ref. No.	Part No.	Description	Remark
< CONNECTOR >			
CN921	1-784-733-11	CONNECTOR, FFC 11P	
< DIODE >			
D921	8-719-057-97	DIODE SEL5923A-TP15 (Ⓚ)	
D922	8-719-058-03	DIODE SEL5423E-TP15 (▷)	
D923	8-719-058-04	DIODE SEL5223S-TP15 (CD SYNC REC)	
D924	8-719-058-04	DIODE SEL5223S-TP15 (REC ●)	
< TRANSISTOR >			
Q921	8-729-027-57	TRANSISTOR DTC143XKA-T146	
Q922	8-729-027-57	TRANSISTOR DTC143XKA-T146	
Q923	8-729-027-57	TRANSISTOR DTC143XKA-T146	
Q924	8-729-027-57	TRANSISTOR DTC143XKA-T146	
< RESISTOR >			
R901	1-249-421-11	CARBON 2.2K	5% 1/4W F
R902	1-247-843-11	CARBON 3.3K	5% 1/4W
R903	1-249-425-11	CARBON 4.7K	5% 1/4W F
R904	1-249-429-11	CARBON 10K	5% 1/4W
R905	1-249-435-11	CARBON 33K	5% 1/4W
R906	1-249-421-11	CARBON 2.2K	5% 1/4W F
R907	1-247-843-11	CARBON 3.3K	5% 1/4W
R908	1-249-425-11	CARBON 4.7K	5% 1/4W F
R909	1-249-429-11	CARBON 10K	5% 1/4W
R921	1-249-409-11	CARBON 220	5% 1/4W F
R922	1-249-409-11	CARBON 220	5% 1/4W F
R923	1-249-409-11	CARBON 220	5% 1/4W F
R924	1-249-409-11	CARBON 220	5% 1/4W F
< SWITCH >			
S901	1-771-410-21	SWITCH, TACTILE (CLEAR)	
S902	1-771-410-21	SWITCH, TACTILE (⊕)	
S903	1-771-410-21	SWITCH, TACTILE (□)	
S904	1-771-410-21	SWITCH, TACTILE (Ⓚ)	
S905	1-771-410-21	SWITCH, TACTILE (▷)	
S906	1-771-410-21	SWITCH, TACTILE (▶▶)	
S907	1-771-410-21	SWITCH, TACTILE (ENTER/YES)	
S908	1-771-410-21	SWITCH, TACTILE (MENU/NO)	
S909	1-771-410-21	SWITCH, TACTILE (REC ●)	
S910	1-771-410-21	SWITCH, TACTILE (CD SYNC REC)	
S911	1-771-410-21	SWITCH, TACTILE (◀◀)	
S981	1-476-088-11	ENCODER, ROTARY (Ⓚ◀◀ ▷▷Ⓚ)	

* 1-671-115-21	SW BOARD	*****	
< CONNECTOR >			
* CN601	1-506-486-11	PIN, CONNECTOR 7P	
< SWITCH >			
S601	1-572-126-21	SWITCH, PUSH (1 KEY) (REC POSITION)	
S602	1-572-126-21	SWITCH, PUSH (1 KEY) (PACK POSITION)	
S604	1-771-264-11	SWITCH, PUSH (DETECTION) (1 KEY)	(PB POSITION)

Ref. No.	Part No.	Description	Remark
		MISCELLANEOUS *****	
1	1-590-218-11	WIRE (FLAT TYPE) (11 CORE)	
14	1-783-140-11	WIRE (FLAT TYPE) (23 CORE)	
15	1-783-139-11	WIRE (FLAT TYPE) (21 CORE)	
17	1-569-972-21	SOCKET, SHORT 2P	
* 358	1-667-954-11	FLEXIBLE BOARD	
△360	A-4672-541-A	OPTICAL PICK-UP KMS-260B/S1NP	
HR901	1-500-502-11	HEAD, OVER LIGHT	
M901	A-4672-474-A	MOTOR ASSY, SLED	
M902	A-4672-475-A	MOTOR ASSY, SPINDLE	
M903	X-4949-264-1	MOTOR ASSY, LOADING	
S901	1-762-148-21	SWITCH, PUSH (2 KEY)	

ACCESSORIES & PACKING MATERIALS

1-574-264-11	CORD, OPTICAL PLUG (AEP)
1-792-923-11	CORD (WITH CONNECTOR) (AEP)
4-230-236-11	MANUAL, INSTRUCTION (ENGLISH) (AEP)
4-230-236-21	MANUAL, INSTRUCTION (FRENCH,SPANISH)(AEP)
4-230-236-31	MANUAL, INSTRUCTION (GERMAN,DUTCH)(AEP)
4-230-236-41	MANUAL, INSTRUCTION (ITALIAN,PORTUGUSE,SWEDISH) (AEP)

HARDWARE LIST

#1	7-685-646-79	SCREW +BVTP 3X8 TYPE2 N-S
#2	7-685-648-79	SCREW +BVTP 3X12 TYPE2 N-S
#3	7-685-871-01	SCREW +BVTT 3X6 (S)
#4	7-685-533-19	SCREW +BTP 2.6X6 TYPE2 N-S
#5	7-627-852-08	SCREW, PRECISION +P 1.7X2.5
#6	7-621-772-40	SCREW +B 2X8
#7	7-621-772-20	SCREW +B 2X5
#8	7-685-133-19	SCREW (DIA. 2.6) (IT3B)

The components identified by mark △ or dotted line with mark △ are critical for safety. Replace only with part number specified.

