

MiniDisc Deck

Operating Instructions

Owner's Record

The model and serial numbers are located on the rear of the unit. Record the serial number in the space provided below. Refer to them whenever you call upon your Sony dealer regarding this product.

Model No. _____

Serial No. _____



MDLP

MDS-S50

WARNING

To prevent fire or shock hazard, do not expose the unit to rain or moisture.

CLASS 1 LASER PRODUCT
LUOKAN 1 LASERLAITE
KLASS 1 LASERAPPARAT

This appliance is classified as a CLASS 1 LASER product. The CLASS 1 LASER PRODUCT MARKING is located on the rear exterior.

The following caution label is located inside the unit.



IN NO EVENT SHALL SELLER BE LIABLE FOR ANY DIRECT, INCIDENTAL OR CONSEQUENTIAL DAMAGES OF ANY NATURE, OR LOSSES OR EXPENSES RESULTING FROM ANY DEFECTIVE PRODUCT OR THE USE OF ANY PRODUCT.

To prevent fire, do not cover the ventilation of the apparatus with news papers, table-cloths, curtains, etc. And don't place lighted candles on the apparatus. To prevent fire or shock hazard, do not place vases on the apparatus.



Don't throw a battery, dispose it as the injurious wastes.

For customers in the U.S.A.

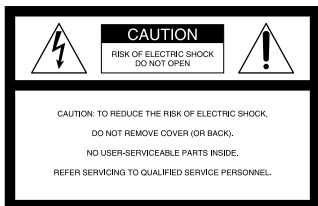

This symbol is intended to alert the user to the presence of uninsulated "dangerous voltage" within the product's enclosure that may be of sufficient magnitude to constitute a risk of electric shock to persons.



This symbol is intended to alert the user to the presence of important operating and maintenance (servicing) instructions in the literature accompanying the appliance.

CAUTION

You are cautioned that any changes or modification not expressly approved in this manual could void your authority to operate this equipment.

INFORMATION

This equipment has been tested and found to comply with the limits for a Class B digital device, pursuant to Part 15 of the FCC Rules. These limits are designed to provide reasonable protection against harmful interference in a residential installation. This equipment generates, uses, and can radiate radio frequency energy and, if not installed and used in accordance with the instructions, may cause harmful interference to radio communications. However, there is no guarantee that interference will not occur in a particular installation. If this equipment does cause harmful interference to radio or television reception, which can be determined by turning the equipment off and on, the user is encouraged to try to correct the interference by one or more of the following measures:

- Reorient or relocate the receiving antenna.
- Increase the separation between the equipment and receiver.
- Connect the equipment into an outlet on a circuit different from that to which the receiver is connected.
- Consult the dealer or an experienced radio/TV technician for help.



ENERGY STAR® is a U.S. registered mark.

As an ENERGY STAR® Partner, Sony Corporation has determined that this product meets the ENERGY STAR® guidelines for energy efficiency.

For customers in Canada

This Class B digital apparatus complies With Canadian ICES-003.

CAUTION

TO PREVENT ELECTRIC SHOCK, DO NOT USE THIS POLARIZED AC PLUG WITH AN EXTENSION CORD, RECEPTACLE OR OTHER OUTLET UNLESS THE BLADES CAN BE FULLY INSERTED TO PREVENT BLADE EXPOSURE.

About this manual

Controls in these instructions are those on the deck; these may, however, be substituted by controls on the supplied remote that are similarly named, or, when different, appear in the instructions within parentheses. Example: Turn AMS clockwise (or press ►► repeatedly).

Table of Contents

Parts Identification

Main unit.....	4
Remote control.....	5

Getting Started

Hooking up the audio components	6
---------------------------------------	---

Recording to MDs

Recording to an MD.....	8
Notes on recording	9
Recording tips	
— Recording for long times/Marking track numbers/Smart Space/Adjusting the recording level/Checking the remaining recordable time/	
Input monitor	9
Starting recording with six seconds of prestored audio data	
— Time Machine Recording	13
Synchro-recording with the audio component of your choice	
— Music Synchro-recording	14
Synchro-recording with a Sony CD player	
— CD Synchro-recording	14

Playing MDs

Loading an MD	16
Playing an MD	
— Normal Play/Shuffle Play/	
Repeat Play	16
Creating your own program	
— Program Play	18

Editing Recorded MDs

Erasing recordings	
— Erase Function.....	19
Dividing recorded tracks	
— Dividing Function	21
Combining recorded tracks	
— Combine Function	22
Moving recorded tracks	
— Move Function	23
Naming a track or MD	
— Name Function	23
Changing the recorded level after recording — S.F EDIT	26
Undoing the last edit — UNDO	28

Other Functions

Fading in and fading out.....	28
Falling asleep to music	
— Sleep Timer	29

Additional Information

Precautions.....	30
Note on MDs	30
System limitations	30
Troubleshooting.....	32
Self-diagnosis function.....	33
Display messages.....	33
Setup menu table	34
Specifications.....	34
Using the beeps (Except for North American model).....	35

The items are arranged in alphabetical order.
Refer to the pages indicated in parentheses () for details.

Main unit

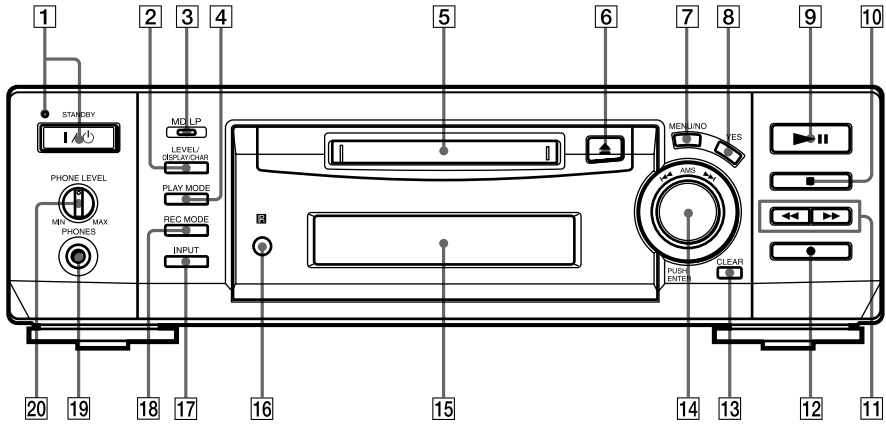

AMS **14** (8) (10) (12) (13) (24)
 CLEAR **13** (18) (24)
 Display **15** (8) (17)
 INPUT **17** (8)
 LEVEL/DISPLAY/CHAR **2** (8)
 (12) (24)
 MD insertion slot **5** (16)
 MD/LP indicator **3** (10) (17)
 MENU/NO **7** (10) (18) (20)

PHONE LEVEL **20** (17)
 PHONES jack **19** (17)
 PLAY MODE **4** (16)
 REC MODE **18** (9)
 Remote sensor **16** (7)
 YES **8** (10) (18) (20)

BUTTON DESCRIPTIONS

- I/⏻ (power)/STANDBY indicator **1** (8) (16)
- ▲ (eject) **6** (8) (17)
- ▶|| (play/pause) **9** (8) (16)
- (stop) **10** (8) (16)
- ◀◀ (go back)/▶▶ (go forward) **11** (17) (18) (24)
- (recording) **12** (8)

Remote control

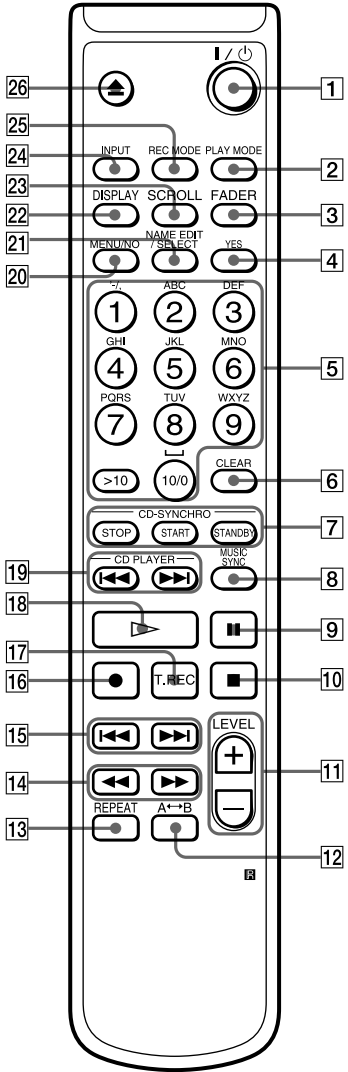

- A↔B **12** (16)
- CD PLAYER **14** (16)
- CD-SYNCHRO STANDBY/START/STOP **7** (14) (15)
- CLEAR **6** (18) (24)
- DISPLAY **22** (8) (12)
- FADER **3** (28)
- INPUT **24** (8)
- Letter/number buttons **5** (17) (25)
- LEVEL +/- **11** (12)
- MENU/NO **20** (10) (18) (20)
- MUSIC SYNC **8** (14)
- NAME EDIT/SELECT **21** (24)
- PLAY MODE **2** (16)
- REC MODE **25** (9)
- REPEAT **13** (16)
- SCROLL **23** (17)
- T.REC **17** (13)
- YES **4** (10) (18) (20)

BUTTON DESCRIPTIONS

- I/⏻ (power) **1** (8) (16)
- ⏸ (pause) **9** (8) (16)
- (stop) **10** (8) (16)
- ◀◀ (fast reverse) ▶▶ (fast forward) **14** (17) (18) (24)
- ◀◀ (go back) ▶▶ (go forward) **15** (8) (10) (16) (25) (26)
- (recording) **16** (8)
- ▶ (play) **18** (16)
- ⬆ (eject) **26** (8) (17)

Hooking up the audio components

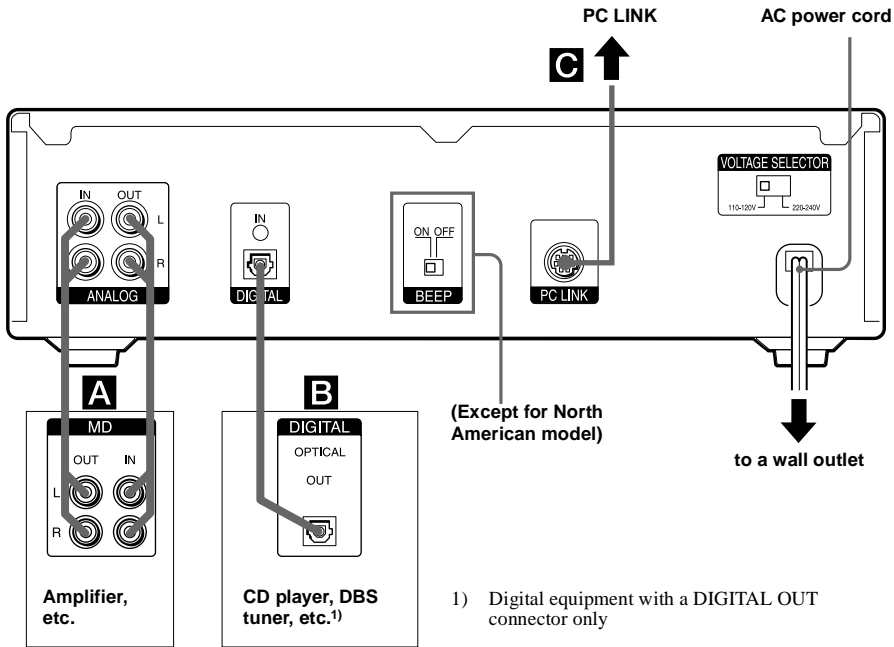

Required cords

A Audio connecting cords (2) (supplied)
 When connecting an audio connecting cord, be sure to match the color-coded pins to the appropriate jacks: white (left) to white and red (right) to red.

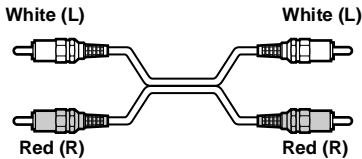

B Optical cables (supplied)

- When connecting an optical cable, take the caps off the connectors and insert the cable plugs straight in until they click into place.
- Do not bend or tie the optical cables.

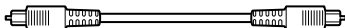

Hookup considerations

- Turn off the power of all components before making any connections.
- Do not connect any AC power cord until all the connections are completed.
- Be sure the connections are firm to prevent hum and noise.

Jacks (connectors) for connecting audio components

Connect	To the
Amplifiers	ANALOG IN/OUT jacks
CD players or DBS tuners	DIGITAL OPTICAL IN connector

Setting the voltage selector (only on models supplied with a voltage selector)

Check that the voltage selector on the rear panel of the deck is set to the local power line voltage. If not, set the selector to the correct position using a screwdriver before connecting the AC power cord to a wall outlet.

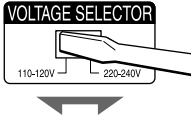

Other connections

To connect a PC

C PC connecting kit (not supplied)

Use the PC connecting kit to connect a PC to the MD deck. By connecting the MD deck to a PC, you will be able to select and play MD tracks and do various editing operations on the PC. For details, refer to the manual supplied with the PC connecting kit.

To connect the AC power cord

Connect the AC power cord of the deck to a wall outlet.

Note

If you use a timer, connect the AC power cord to the outlet of the timer.

Inserting batteries into the remote

Insert two R6 (size-AA) batteries into the battery compartment with the + and – properly oriented to the markings. When using the remote, point it at the remote sensor  on the deck.

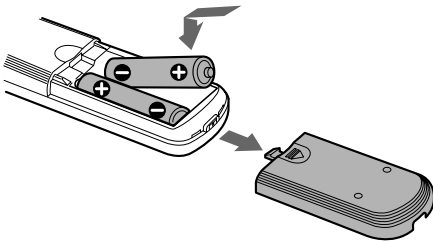

Tip

When the remote no longer operates the deck, replace both batteries with new ones.

Notes

- Do not leave the remote in an extremely hot or humid place.
- Do not drop any foreign object into the remote casing, particularly when replacing the batteries.
- Do not use a new battery with an old one.
- Do not expose the remote sensor to direct sunlight or lighting apparatus. Doing so may cause a malfunction.
- If you don't use the remote for an extended period of time, remove the batteries to avoid possible damage from battery leakage and corrosion.

Demonstration mode

When you turn on the MD deck and there is no MD in the deck, demonstration mode is activated automatically after about ten minutes. To deactivate demonstration mode, press any button on the deck or on the remote.

Tip

To turn off demonstration mode, press  and CLEAR simultaneously when there is no MD in the deck. "Demo Off" appears in the display. To turn on demonstration mode again, perform the same procedure described above. "Demo On" appears in the display.

Recording to an MD

If the MD has been partially recorded, recording starts after the recorded tracks.

- 1 **Turn on the amplifier and program source, and select the source on the amplifier.**
- 2 **Press I/⏻ to turn on the deck.**
The STANDBY indicator turns off.
- 3 **Load a recordable MD into the slot (page 16).**
- 4 **Press INPUT repeatedly to select the input jacks (connector) connected to the program source.**

When the source is connected to the	Set INPUT to
DIGITAL OPTICAL IN connector	D-IN
ANALOG IN jacks	A-IN

- 5 **If necessary, locate the point on the MD to start recording from.**

If you want to record to a new MD or start recording from the end of the recorded portion, skip this step and go to step 6.

To record over from the beginning of an existing MD track: Turn AMS (or press ◀◀/▶▶) repeatedly until the number of the track to be recorded over appears.

To record over from the middle of an MD track: Turn AMS (or press ◀◀/▶▶) repeatedly until the number of the track to be recorded over appears, then press ▶▶ (or ▶) to start play. Press ▶▶ (or ▶▶) at the point you want to start recording from.

- 6 **Press ●.**
The deck changes to recording pause.
- 7 **If necessary, adjust the recording level.**
For details, see “Adjusting the recording level” on page 12.

- 8 **Press ▶▶ (or press ▶ or ▶▶).**

Recording starts.

The MD deck is recording over existing track(s). “Tr” flashes in the display during recording. The indication stops flashing when the deck reaches the end of the recorded portion.

9 Start playing the program source.

Operations you may want to do during recording

To	Press
Stop recording	■
Pause recording	▶▶ (or ▶▶)
Resume recording after pausing ¹⁾	▶▶ (or press ▶ or ▶▶)
Eject the MD	▲ after stopping recording

1) The track number increases by one.

To change the display while recording

Press LEVEL/DISPLAY/CHAR (or DISPLAY) repeatedly to change the display.

Each press of the button changes the display cyclically as follows:

Track number and recorded time of the current track → Remaining recordable time²⁾ on the MD → Level of the input signal → Track name³⁾

- 2) Time shown in the display differs depending on the setting of REC MODE.
- 3) “No Name” appears when the track has no name.

Note

You cannot record over existing material when Shuffle Play (page 16) or Program Play (page 16) has been selected. “Impossible” appears in the display at this time.

Notes on recording

After recording

Press **▲** to remove the MD or press **I/⏻** (power) to turn off the unit.

“TOC” lights up, or either “TOC” or “STANDBY” starts flashing. The TOC is updated and recording is completed.

Before pulling out the power cord

MD recording is completed when the MD Table of Contents (TOC) is updated. The TOC is updated when you eject the MD or press **I/⏻** to turn off the unit. Do not pull out the power cord before updating the TOC (while “TOC” is lit) or while updating the TOC (while “TOC” or “STANDBY” is flashing) to ensure a complete recording.

Converting digital sampling rates automatically

A built-in sampling rate converter automatically converts the sampling frequency of various digital sources to the 44.1 kHz sampling rate of the MD deck. This allows you to monitor and record sources such as 32- or 48-kHz DAT tape or satellite broadcasts, as well as the CDs and MDs.

To prevent accidental erasure of the recorded material

To protect an MD recording, slide the record-protect tab in the direction of the arrow (see illustration below) to open the slot. To enable re-recording, close the slot.

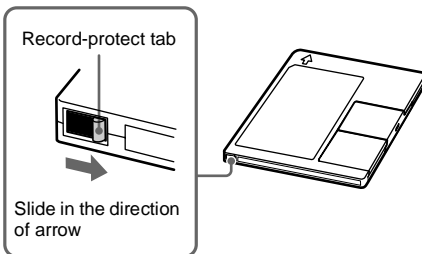

Recording tips

— **Recording for long times/Marking track numbers/Smart Space/Adjusting the recording level/Checking the remaining recordable time/Input monitor**

Recording for long times

In addition to normal stereo recording, this deck has two long time recording modes: LP2 and LP4. When recording in LP2 Stereo mode, you can record 2 times the normal recordable time, and in LP4 Stereo mode, you can record 4 times the normal recordable time. In addition, the recordable time for monaural recording is approximately double the stereo recording time. LP4 Stereo mode (4× long time recording mode) achieves a long stereo recording time by use of a special compression system. When placing emphasis on sound quality, Stereo recording or LP2 Stereo recording (2× long time recording mode) is recommended.

Note

MDs recorded in MD LP (LP2 or LP4 Stereo) mode cannot be played back on a deck that does not support MD LP mode. In addition, you cannot perform S.F Edit for MDs recorded in MD LP mode.

- 1 Do steps 1 to 4 of “Recording to MDs” on page 8.
- 2 Press **REC MODE** repeatedly to select the recording mode you want to record in.

To record in	Set REC MODE to
Stereo	Blank (No indicator)
LP2 Stereo	LP2
LP4 Stereo	LP4
Monaural	MONO

- 3 Do steps 5 to 9 of “Recording to MDs” on page 8.

continued

Recording tips (continued)

Tips

- During recording to an MD in LP2 or LP4 Stereo mode, the MD LP indicator lights up when you press ● in step 3 above.
- The deck is set at the factory to add "LP:" at the beginning of a track name automatically. This indication is displayed when the track is played on a deck that does not support long-time recording. To turn off this function, do the following procedure.

- 1 While the deck is stopped or playing, press MENU/NO twice.
"Setup Menu" appears in the display.
- 2 Turn AMS (or press ◀◀/▶▶ repeatedly) until "LPstamp On" (factory setting) appears, then press AMS or YES.
- 3 Turn AMS (or press ◀◀/▶▶ repeatedly) to select "LPstamp Off", and then press AMS or YES.
- 4 Press MENU/NO.

To add "LP:" automatically again, select "LPstamp On" in step 3 above.

Notes

- The recorded "LP:" is a confirmation stamp that is displayed to indicate that the track cannot be played back on a deck that does not support MD LP mode. It is not displayed on decks that support MD LP mode.
- If "LPstamp:On" is set, "LP:" is recorded as part of the track name, so the number of characters that can be input in a single MD is reduced. Furthermore, "LP:" is automatically copied if the track name is copied or if the track is divided by using the Divide function.
- MDs recorded in MD LP (LP2 or LP4 Stereo) mode should be played back on a deck that supports MD LP mode. These MDs cannot be played back on other decks.
- Even if you press REC MODE during recording or recording pause, you cannot change the recording mode.
- Even if you press REC MODE repeatedly to select MONO, the monitor signal during recording does not become monaural.

Marking track numbers while recording

— Manual /Automatic Track Marking

You can mark track numbers either manually or automatically while recording. By marking track numbers at specific points, you can quickly locate the points later or edit the MD easily.

Marking track numbers manually
(Manual Track Marking)

While recording, press ● at the point where you want to add a track number.

Marking track numbers automatically
(Automatic Track Marking)

When recording from a CD player or MD deck connected to a DIGITAL IN connector, the deck marks track numbers in the same sequence as the source. When recording from other sources connected to the DIGITAL IN connector or a source connected to the ANALOG IN jacks, do the procedure below to mark track numbers automatically. However, you cannot mark track numbers automatically if the sound source to be recorded is noisy (e.g., tapes or radio programs).

- 1 **While the deck is stopped, press MENU/NO twice.**

"Setup Menu" appears in the display.

- 2 **Turn AMS (or press ◀◀/▶▶ repeatedly) until "T.Mark Lsync" appears, then press AMS or YES.**

- 3 **Turn AMS (or press ◀◀/▶▶ repeatedly) to select the setting, then press AMS or YES.**

To	Select
Turn on Automatic Track Marking	T.Mark Lsync (factory setting)
Turn off Automatic Track Marking	T.Mark Off

4 Press MENU/NO.

When you set Automatic Track Marking to on, “L.SYNC” lights up.

The deck marks a track number whenever the input signal level drops to -50 dB¹⁾ (the trigger level for Automatic Track Marking) or below for at least 1.5 seconds.

1) Factory setting

To change the trigger level for Automatic Track Marking

Do the procedure below to change the signal level that triggers Automatic Track Marking.

1 While the deck is stopped, press MENU/NO twice.

“Setup Menu” appears in the display.

2 Turn AMS (or press ◀◀/▶▶ repeatedly) until “LS(T)” appears, then press AMS or YES.

3 Turn AMS (or press ◀◀/▶▶ repeatedly) to select the level, then press AMS or YES.

You can set the level at any value between -72 dB and 0 dB, in 2 dB increments.

4 Press MENU/NO.

Tips for automatic track marking

- When recording from a CD player or an MD deck connected to the DIGITAL IN connector, the entire material might be recorded as a single track in the following cases:
 - When you consecutively record the same track two or more times using single-track repeat play.
 - When you consecutively record two or more tracks with the same track number but from different CDs or MDs.
 - When you record tracks from certain CD or multi-disc players.
- A track number might not be marked for tracks less than 4 seconds long (in Stereo mode, Monaural mode, and LP2 Stereo mode) or 8 seconds long (in LP4 Stereo mode) during recording.
- When recording from a component connected to the ANALOG IN jacks with “T.Mark Off” selected or when recording from a DAT deck or DBS tuner connected to the DIGITAL IN connector, the entire material may be recorded as a single track.
- When recording from a DAT deck or DBS tuner connected to the DIGITAL IN connector, the deck will mark a track number whenever the sampling frequency of the input signal changes, regardless of the track marking parameter setting (“T.Mark Lsync” or “T.Mark Off”).

Tip

You can mark track numbers even after recording has finished. See “Dividing recorded tracks” on page 21.

Erasing blank portions automatically (Smart Space/ Auto Cut)

The Smart Space function lets you make the blank spaces between tracks 3 seconds long automatically. If the Smart Space function is on and there is no sound input for about 3 seconds or more (but less than 30 seconds) while recording, the MD deck replaces this silence with a blank of about 3 seconds and continues recording.

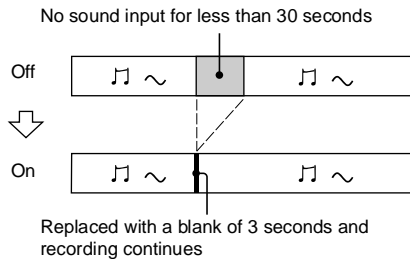

Auto Cut: When the Smart Space function is on, if there is no sound input for 30 seconds or more, the MD deck replaces this silence with a blank of about 3 seconds and enters recording pause.

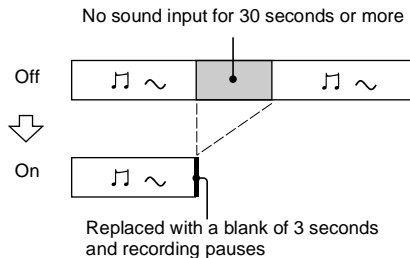

continued

Recording tips (continued)

- 1 While the deck is stopped, press **MENU/NO** twice.
“Setup Menu” appears in the display.
- 2 Turn **AMS** (or press **◀◀/▶▶** repeatedly) until “S.Space On” appears, then press **AMS** or **YES**.
- 3 Turn **AMS** (or press **◀◀/▶▶** repeatedly) to select the setting, then press **AMS** or **YES**.

To	Select
Turn on Smart Space and Auto Cut	S.Space On (factory setting)
Turn off Smart Space and Auto Cut	S.Space Off

4 Press **MENU/NO**.

Notes

- Smart Space does not affect the order of the track numbers being recorded, even if the blank space occurs in the middle of a track.
- Auto Cut is automatically turned on or off in tandem with Smart Space.
- If the deck continues recording pause for about 10 minutes after the Auto Cut activated, recording stops automatically.

Adjusting the recording level

You can adjust the recording level for both analog and digital recordings.

- 1 Do steps 1 to 6 of “Recording to MDs” on page 8.
- 2 Play the portion of the program source with the strongest output.
- 3 Press **LEVEL/DISPLAY/CHAR** (or **DISPLAY**) repeatedly until the level of the input signal appears.
- 4 While monitoring the sound, turn **AMS** (or press **LEVEL +/-** repeatedly) to raise the recording level to its highest level without turning on “OVER” on the peak level meters.



Avoid turning on these indicators

- 5 Stop playing the program source.
- 6 To start recording, continue from step 8 of “Recording to MDs” on page 8.

Tips

- To adjust the recording level, press **LEVEL +/-** on the remote repeatedly during recording or recording pause.
- Peak hold function freezes the peak level meters at the highest level reached by the input signal.

- 1 While the deck is stopped, press **MENU/NO** twice.
“Setup Menu” appears in the display.
- 2 Turn **AMS** (or press **◀◀/▶▶** repeatedly) until “P.Hold Off” (factory setting) appears, then press **AMS** or **YES**.
- 3 Turn **AMS** (or press **◀◀/▶▶** repeatedly) to select “P.Hold On”, then press **AMS** or **YES**.
- 4 Press **MENU/NO**.

To turn off the Peak Hold Function, select “P.Hold Off” in step 3 above.

Note

The volume can only be increased up to +12.0 dB (for analog recording) or +18.0 dB (for digital recording). Therefore, if the output level of the connected component is low, it may not be possible to set the recording level to maximum.

Checking the remaining recordable time on the MD

Press **DISPLAY** on the remote repeatedly.

For the information in stop mode, see page 17.

For the information during recording, see page 8.

Monitoring the input signal (Input Monitor)

You can monitor the selected input signal even when you are not recording it.

- 1 Press **▲** to eject the MD.
- 2 Press **INPUT** repeatedly to select the **jacks (connector) where the signal you want to monitor is being input.**
- 3 Press **●**.

When an analog input is selected

The analog signal input from the ANALOG IN jacks is output to the ANALOG OUT jacks and PHONES jack. "AD - DA" appears in the display during this time.

When a digital input is selected

The digital signal input from the DIGITAL IN connector is output to the ANALOG OUT jacks and PHONES jack after D/A conversion. "- DA" appears in the display during this time.

To stop Input Monitor

Press **■**.

Starting recording with six seconds of prestored audio data

— Time Machine Recording

When recording from an FM or satellite broadcast, the first few seconds of material are often lost due to the time it takes you to ascertain the contents and press the record button. To prevent the loss of this material, the Time Machine Recording feature constantly stores the most recent audio data in a buffer memory. This lets you record the sound from 6 seconds before starting recording, as shown in the illustration below:

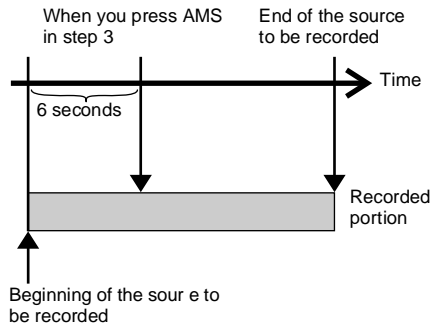

- 1 Do steps 1 to 6 of "Recording to MDs" on page 8.

The deck changes to recording pause.

- 2 Start playing the program source.

- 3 Press **AMS (or T.REC)** at the point where you want to start recording.

Recording starts with the six seconds of prestored data in the buffer memory, then continues recording via the buffer memory thereafter.

Synchro-recording with the audio component of your choice

— Music Synchro-recording

The Music Synchro-recording allows you to automatically synchronize recording to the MD deck with the playing of the selected program source. The Track Marking Function, however, will differ according to the program source. For details, see “Marking track numbers while recording” on page 10.

1 Do steps 1 to 5 of “Recording to MDs” on page 8.

2 Press MUSIC SYNC on the remote.

The deck changes to recording pause.

3 Start playing the program source.

Recording starts automatically.

Note

During Music Synchro-recording, Smart Space and Auto Cut will operate regardless of their setting (“S.Space On” or “S.Space Off”).

Synchro-recording with a Sony CD player

— CD Synchro-recording

When the deck is connected to a Sony CD player or Hi-Fi component system, you can easily copy the contents of CDs to the MD using the deck’s remote. Because the MD remote operates both the MD deck and the CD player or CD player section of the component system, make sure to place the MD deck and the CD player as close together as possible.

1 Turn on the amplifier and the CD player, and select CD on the amplifier.

2 Do steps 2 to 5 of “Recording to MDs” on page 8.

3 Insert a CD into the CD player and select the playing mode (Shuffle Play, Program Play, etc.) on the CD player.

4 Press CD-SYNCHRO STANDBY on the remote.

The CD player changes to play standby and the MD deck changes to recording standby.

5 Press CD-SYNCHRO START on the remote.

The deck starts recording and the CD player starts to play.

The track number and elapsed recording time of the track appear in the display.

If the CD player does not start playing

Some CD players may not respond when you press CD-SYNCHRO START on the remote. Press **■** on the CD player’s remote instead to start play on the CD player.

Operations you may want to do during CD Synchro-recording

To	Press
Stop recording	CD-SYNCHRO STOP on the remote
Pause recording	CD-SYNCHRO STANDBY on the remote
Locate the next track to be recorded during recording pause	CD PLAYER ◀◀/▶▶ on the remote
Resume recording after pausing	CD-SYNCHRO START on the remote
Check the remaining recordable time on the MD	DISPLAY

Tips

- You can use the remote of the CD player during CD Synchro-recording.

Press	To change the deck to	And change the CD player to
▷	Recording	Play
■	Recording pause	Stop
	Recording pause	Pause

- During CD Synchro-recording, track numbers are marked in the following ways:
 - When the CD player is connected to the DIGITAL IN connector, track numbers are automatically marked as they appear on the CD.
 - When the CD player is connected to the ANALOG IN jacks, track numbers are automatically marked when “T.Mark Lsync” has been selected (page 10).
 - When you resume recording after recording pause, a new track number is automatically marked, regardless of the track marking parameter setting (“T.Mark Lsync” or “T.Mark Off”).
- By reprogramming the MD’s remote, you can use the procedure above to perform synchro-recording with a Sony video CD player.
Press number button 2 on the remote while pressing down I/⏏ on the remote. You can now operate the MD deck and the video CD player with the remote. To control the CD player again, press number button 1 on the remote while pressing down I/⏏ on the remote.

Notes

- When performing CD Synchro-recording with a CD player with a mode selector, be sure to set the selector to CD1.
- When you record tracks from certain CD or multi-disc players, the entire material may be recorded as a single track.

Loading an MD

Load an MD as illustrated below.

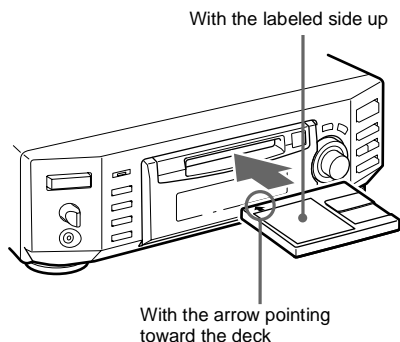

Playing an MD

— Normal Play/Shuffle Play/Repeat Play

- 1 Turn on the amplifier and select MD on the amplifier.
- 2 Press I/⏻ to turn on the deck.
The STANDBY indicator turns off.
- 3 Load an MD.
- 4 Press PLAY MODE repeatedly until the mode you want appears in the display.

Select	To play
Blank (no PLAY MODE indication)	The MD in original order.
SHUF	The tracks in random order.
PGM	The tracks in the order you want them to be played.

- 5 Press ►||. The deck starts to play.
- 6 Adjust the volume on the amplifier.

Repeat Play Operations

To	Do the following
Repeat only one track	Press REPEAT repeatedly until "Repeat 1" appears in the display.
Repeat all tracks	Press REPEAT repeatedly until "Repeat All" appears in the display.
Cancel Repeat Play	Press REPEAT repeatedly until "Repeat Off" appears in the display.
Repeat a specific portion within a track (Repeat A – B Play)	<ol style="list-style-type: none"> 1 While the deck is playing, press A↔B on the remote at the starting point (point A) of the portion to be played repeatedly. "REP A-" lights up and "B" flashes in the display. 2 Continue playing the track or press ►► on the remote to locate the ending point (point B), then press A↔B on the remote. "REP A-B" lights up and Repeat A-B Play starts.
Cancel Repeat A – B Play	Press REPEAT or CLEAR on the remote.

Other Operations

To	Press or turn
Stop play	■
Pause play	► (or)
Resume play after pausing	► (or press ► or)
Go to the next or a succeeding track during play	AMS ¹⁾ clockwise (or press ► repeatedly).
Go to a preceding track during play	AMS counterclockwise (or press ◄ repeatedly).
Go to the beginning of the current track during play	AMS counterclockwise (or press ◄ once).
Go to a specific track while the deck is stopped	AMS (or press ◄/► repeatedly) until the track number you want to go to flashes in the display, then press AMS or ► (or ►).

To	Press or turn
Find a point in a track	Press and hold ►► or ◀◀ during play ²⁾ or play pause ³⁾ and release it at the desired point.
Eject the MD	▲ after stopping play

- 1) Automatic Music Sensor
- 2) When you locate a point while monitoring the sound.
- 3) When you locate by observing the time indication.

Tips

- While playing an MD recorded in LP2 or LP4 Stereo mode, the MD LP indicator lights up when you press ►► in step 5 above.
- To use headphones, connect them to the PHONES jack. Turn PHONE LEVEL to adjust the headphones level.
- When “- Over -” appears in the display, the MD has reached the end while you’re pressing ►►. Turn AMS counterclockwise (or press ◀◀) or press ◀◀ to go back.

Playing a track by entering the track number

Press the number button(s) on the remote to enter the track number of the track you want to play.

To enter a track number over 10

- 1 Press >10.
- 2 Enter the corresponding digits.
To enter 0, press 10/0 instead.

Examples:

- To play track number 30, press >10, then 3 and 10/0.
- To play track number 108, press >10 twice, then 1, 10/0, and 8.

Using the MD display

To change the display during playing, press DISPLAY on the remote repeatedly.

Each press of the button changes the display cyclically as follows:

Track number and elapsed time of the current track → Track number and remaining time of the current track → Remaining time of all recorded tracks → The contents of a program (only when “PGM” lights up) → Track name¹⁾

Tip

To check the track name while playing (only when the track name is recorded), press SCROLL on the remote.

The track name appears and scrolls. While the track name is scrolling, press the button again to pause scrolling, and again to continue scrolling.

To change the display in stop mode, press DISPLAY repeatedly.

Each press of the button changes the display cyclically as follows:

Total number of tracks and total recorded time → Remaining recordable time²⁾ on the MD (recordable MDs only) → The contents of a program (only when “PGM” lights up) → Total playing time of the program (only when “PGM” lights up) → Disc name¹⁾

- 1) “No Name” appears when the disc has no name.
- 2) Time shown in the display differs depending on the setting of REC MODE.

Creating your own program

— Program Play

You can pick out the tracks that you like and specify the playing order in a program containing up to 25 tracks.

Programming the tracks

- 1 While the deck is stopped, press MENU/NO twice.**

“Setup Menu” appears in the display.

- 2 Turn AMS (or press ◀◀/▶▶ repeatedly) until “Program ?” appears, then press AMS or YES.**

- 3 Turn AMS (or press ◀◀/▶▶ repeatedly) until the track number you want to add to the program appears, then press AMS or ▶▶ (or use the number button(s) on the remote to enter the track directly).**

If you entered the wrong track number

Press ◀◀/▶▶ repeatedly until the wrong track number flashes, then do step 3 above again or press CLEAR to erase the track number. If “0” flashes, press ◀◀ so that the last track number flashes, then enter a correct number.

To enter a track number over 10

Use >10. For details, see page 17.

- 4 Repeat step 3 to enter other tracks.**

The entered track is added to the location where the “0” flashes.

Each time you enter a track, the total program time appears in the display.

- 5 Press YES.**

“Complete!!” appears and the program is completed.

- 6 Press PLAY MODE repeatedly until “PGM” lights up in the display.**

- 7 Press ▶|| (or ▶).**

Program Play starts.

Notes

- If you eject the MD, the program will be lost.
- The display shows “- - - -” when the total playing time of the program exceeds 999 minutes.

Checking the order of the program

While the deck is stopped and “PGM” lights up, press DISPLAY repeatedly.

The first several tracks in the program appear in the display. To see the rest of the program, turn AMS (or press ▶▶ repeatedly).

Changing the contents of the program

While the deck is stopped and “PGM” lights up, do steps 1 and 2, followed by one of the procedures below:

To	Do the following:
Erase a track	Press ◀▶ repeatedly until the number of the unwanted track flashes, then press CLEAR.
Erase all tracks	Press down CLEAR until all the track numbers disappear.
Add a track at the beginning of the program	Press ◀ repeatedly until “0” flashes before the first track number, then do steps 3 to 5.
Add a track in the middle of the program	Press ◀▶ repeatedly until the track number which will precede the new track flashes. Press AMS to display flashing “0,” then do steps 3 to 5.
Add a track to the end of the program	Press ▶ repeatedly until “0” flashes after the last track number, then do steps 3 to 5.
Replace a track	Press ◀▶ repeatedly until the number of the track to be changed flashes, then do steps 3 to 5.

Before editing

You can edit an MD only when:

- The MD is recordable.
- The MD play mode is normal play.

Check the following, before editing.

Canceling the last edit

Use Undo Function to cancel the last edit and restore the contents of the MD to the condition before the edit.

To quit while editing

Press MENU/NO.

After editing

Press ▲ to remove the MD or press I/⏻ (power) to turn off the unit.

“TOC” lights up, or either “TOC” or “STANDBY” starts flashing. The TOC is updated and recording is completed.

Before pulling out the power cord

MD editing is completed when the MD Table of Contents (TOC) is updated. The TOC is updated when you eject the MD or press I/⏻ to turn off the unit. Do not pull out the power cord before updating the TOC (while “TOC” is lit) or while updating the TOC (while “TOC” or “STANDBY” is flashing) to ensure a complete editing.

Erasing recordings

— Erase Function

The MD deck lets you erase unwanted tracks quickly and easily.

The three options for erasing recordings are:

- Erasing a single track (Track Erase Function)
- Erasing all tracks (All Erase Function)
- Erasing a portion of a track (A - B Erase Function)

continued

Erasing recordings (continued)

Erasing a single track

— Track Erase Function

You can erase a track simply by selecting its track number. When you erase a track, the total number of tracks on the MD decreases by one and all the tracks following the erased one are renumbered.

Example: Erasing track 2.

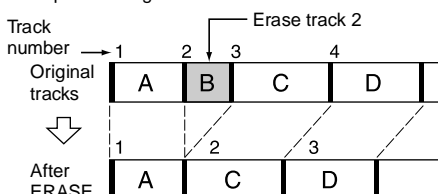

1 While the deck is stopped, playing, or paused, press MENU/NO.

“Edit Menu” appears in the display.

2 Turn AMS (or press ◀◀/▶▶ repeatedly) until “Tr Erase ?” appears, then press AMS or YES.

The deck starts to play the track indicated by the number in the display.

3 Turn AMS (or press ◀◀/▶▶ repeatedly) until the track number you want to erase appears.

4 Press AMS or YES.

“Complete!!” appears. The track following the erased track starts to play. If the erased track is the last one on the MD, the track preceding the erased track starts to play.

Tip

If “Erase ???” appears in step 4 above, the track has been record-protected on another MD deck. If you still want to erase the track, press AMS or YES again while the indication appears.

Erasing all the tracks on an MD

— All Erase Function

Do the procedure below to erase all the tracks, track names, and disc name at once.

1 While the deck is stopped, playing, or paused, press MENU/NO.

“Edit Menu” appears in the display.

2 Turn AMS (or press ◀◀/▶▶ repeatedly) until “All Erase ?” appears, then press AMS or YES.

“All Erase ???” appears in the display.

3 Press AMS or YES.

“Complete!!” appears.

Erasing a portion of a track

— A-B Erase Function

You can specify a portion within a track and erase the portion with ease. You can shift the desired portion by frame¹⁾, minute or second intervals.

1) 1 frame is 1/86 second.

Example: Erasing a portion of track 2.

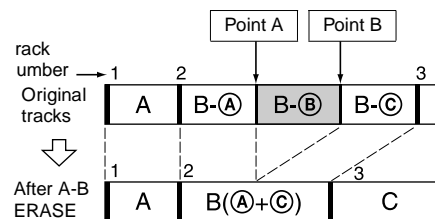

1 While the deck is stopped, playing, or paused, press MENU/NO.

“Edit Menu” appears in the display.

2 Turn AMS (or press ◀◀/▶▶ repeatedly) until “A-B Erase ?” appears, then press AMS or YES.

- 3 Turn AMS (or press ◀◀/▶▶ repeatedly) until the number of the track containing the portion to be erased appears, then press AMS or YES.**

“-Rehearsal-” and “Point A ok?” alternate in the display and the deck repeatedly plays several seconds of the track before the point AMS or YES was pressed.

- 4 While monitoring the sound, turn AMS (or press ◀◀/▶▶ repeatedly) to locate the starting point of the portion to be erased (point A).**

You can shift the starting point by 1-frame¹⁾ intervals (1 frame = 1/86 second).

The time indication (minute, second, and frame) of the current point is displayed and the deck plays several seconds of the track to that point repeatedly.

- 1) When recording in Stereo mode, you can shift the starting point by 2-frame intervals (in Monaural mode and LP2 Stereo mode) or by 4-frame intervals (in LP4 Stereo mode).

To find a point quickly

Specify a unit (minute, second, or frame) by which the MD is advanced when you turn AMS (or press ◀◀/▶▶ repeatedly). To do this, press ◀◀/▶▶ in step 4 repeatedly to select minute, second, or frame. The selected unit flashes in the display.

- 5 Repeat step 4 until you have located point A.**

- 6 Press AMS or YES to enter point A.**

“Point B set” appears and the deck starts playing from point A until the track ends.

- 7 Continue playing the track or press ▶▶ to locate the ending point of the portion to be erased (point B), then press AMS or YES.**

“A-B Ers” and “Point B ok?” alternate in the display and a few seconds of the track before point A and after point B play back repeatedly.

- 8 Repeat step 4 until you have located point B.**

- 9 Press AMS or YES to enter point B.**

“Complete!!” appears.

Note

If “Impossible” appears in the display, you cannot erase a portion of a track. This happens when you have edited the same track many times.

This is due to a technical limitation of the MD system and is not a mechanical error.

Dividing recorded tracks

— Dividing Function

You can use this function to mark track numbers after recording. The total number of tracks increases by one and all the tracks following the divided ones are renumbered.

Example: Dividing track 2 into two tracks.

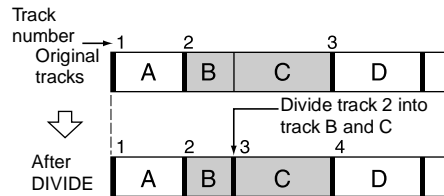

Dividing a track after selecting the track

- 1 While the deck is stopped, playing, or paused, press MENU/NO.**

“Edit Menu” appears in the display.

- 2 Turn AMS (or press ◀◀/▶▶ repeatedly) until “Divide ?” appears, then press AMS or YES.**

- 3 Turn AMS (or press ◀◀/▶▶ repeatedly) until the number of the track you want to divide appears, then press AMS or YES.**

“-Rehearsal-” appears and the deck repeatedly plays several seconds of the track from the point AMS or YES was pressed.

continued

Dividing recorded tracks (continued)

4 While monitoring the sound, turn AMS (or press ◀◀/▶▶ repeatedly) to locate the dividing point.

You can shift the starting point by 1-frame¹⁾ intervals (1 frame = 1/86 second).

The time indication (minute, second, and frame) of the current point is displayed and the deck plays several seconds of the track to that point repeatedly.

- 1) When recording in Stereo mode, you can shift the starting point by 2-frame intervals (in Monaural mode and LP2 Stereo mode) or by 4-frame intervals (in LP4 Stereo mode).

To find a point quickly

Specify a unit (minute, second, or frame) by which the MD is advanced when you turn AMS (or press ◀◀/▶▶ repeatedly).

To do this, press ◀◀/▶▶ in step 4 repeatedly to select minute, second, or frame. The selected unit flashes in the display.

5 Repeat step 4 until you have located the dividing point.

6 Press AMS or YES.

“Complete!!” appears and the deck starts to play the newly created track. Note that new track has no name.

Tip

You can divide tracks while recording. For details, see “Marking track numbers while recording” on page 10.

Dividing a track after selecting the dividing point

1 While the deck is playing, press AMS at the point you want to divide the track.

“- Divide -” and “-Rehearsal-” alternate in the display and the deck starts to play from the selected point repeatedly.

2 If necessary, do step 4 of “Dividing a track after selecting the track” on page 33 to finely adjust the dividing point.

3 Press YES.

“Complete!!” appears for a few seconds and the track is divided. The deck starts to play the newly created track. Note that new track has no name.

Combining recorded tracks

— Combine Function

You can use this function to combine 2 tracks into a single track. The total number of tracks decreases by one and all tracks following the combined ones are renumbered.

You can also use this function to erase unnecessary track numbers.

Example: Combining track 3 to track 1.

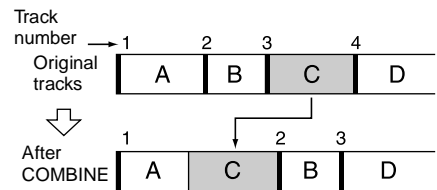

Example: Combining track 1 to track 4.

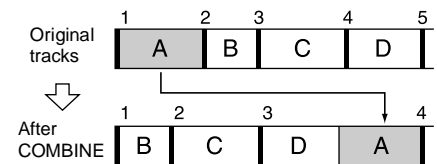

If both of the combined tracks have a track name, the name of the second track is erased.

1 While the deck is stopped, playing, or paused, press MENU/NO.

“Edit Menu” appears in the display.

2 Turn AMS (or press ◀◀/▶▶ repeatedly) until “Combine ?” appears, then press AMS or YES.

3 Turn AMS (or press ◀◀/▶▶ repeatedly) until the number of the first track of the two to be combined appears, then press AMS or YES.

The display for selecting a second track appears and the deck plays the portion where joining will occur (the end of the first track and the beginning of the second track following it) repeatedly.

4 Turn AMS (or press ◀◀/▶▶ repeatedly) until the number of the second track of the two to be combined appears, then press AMS or YES.

“Complete!!” appears and the deck starts to play the combined track.

Notes

- Tracks recorded in different modes (stereo, MONO, LP2 or LP4) cannot be combined.
- If both of the combined tracks have track titles, the title of the second track is erased.
- If “Impossible” appears in the display, the tracks cannot be combined because repeated editing has been done to the track(s). This is a technical limitation of the MD system and is not a mechanical error.

Moving recorded tracks

— Move Function

You can use this function to change the order of any track on the disc. When you move tracks, the tracks are automatically renumbered.

Example: Moving track 3 to position 2.

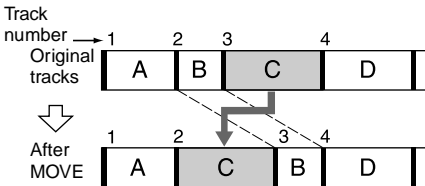

1 While the deck is stopped, playing, or paused, press MENU/NO. “Edit Menu” appears in the display.

2 Turn AMS (or press ◀◀/▶▶ repeatedly) until “Move ?” appears, then press AMS or YES.

3 Turn AMS (or press ◀◀/▶▶ repeatedly) until the number of the track to be moved appears, then press AMS or YES.

4 Turn AMS (or press ◀◀/▶▶ repeatedly) until the new track position appears, then press AMS or YES.

“Complete!!” appears and the deck starts to play the moved track.

Naming a track or MD

— Name Function

You can enter a name for a recorded MD as well as for individual tracks. Names can consist of uppercase and lowercase letters, numbers, and symbols. A total number of about 1,700 characters can be stored for all the names on the MD.

Note

If you name a track while it is being recorded, be sure to finish the naming operation before the track ends. If the track ends before you finish, the entered character data will be discarded and the track will remain unnamed. Also, you cannot name tracks while the deck is recording over existing material.

Naming a track or an MD using the controls on the deck

1 Press MENU/NO.

“Edit Menu” appears in the display.

To enter a name while the deck is recording, go to step 3.

2 Turn AMS until “Name ?” appears, then press AMS or YES.

continued

Naming a track or MD (continued)

- 3 Turn AMS until “Nm In ?” appears, then press AMS or YES.**

While the deck is recording, a flashing cursor appears in the display and you can enter a name for the track being recorded. In this case, go to step 5.

- 4 Turn AMS until the track number (when naming a track) or “Disc” (when naming the MD) flashes, then press AMS or YES.**

A flashing cursor appears.
The deck starts playing and you can name a track while monitoring the sound.

- 5 Press LEVEL/DISPLAY/CHAR repeatedly to select the character type.**

Each time you press the button, the display changes cyclically as follows:
■ ■ ■ (Blank space) → A (Upper cases) → a (Lower cases) → 0 (Numbers) → ‘ (Symbols)

To enter a space

Press ►► while the cursor is flashing. You cannot enter a space as the first character.

- 6 Turn AMS to select the character.**

The selected character flashes.

To enter a symbol

You can use the following symbols in titles:
' - / , . () : ! ? & + < > _ = " ; # \$ % @ * `

To change a selected character

Repeat steps 5 and 6.

- 7 Press AMS.**

The selected character is entered and lights continuously. The cursor shifts to the right, flashes, and waits for the input of the next character.

- 8 Repeat steps 5 to 7 to enter the rest of the name.**

To change a character

Press ◀◀/▶▶ repeatedly until the character to be changed flashes, then repeat steps 5 to 7.

To erase a character

Press ◀◀/▶▶ repeatedly until the character to be erased flashes, then press CLEAR.

- 9 Press YES.**

The whole name appears in the display, followed by “Complete!!”.

Naming a track or an MD using the remote

- 1 Press NAME EDIT/SELECT while the deck is in one of the operating modes listed below, depending on what you want to name:**

To name	Press while
A track	The track number displayed
The MD	The deck is stopped with total number of tracks displayed

A flashing cursor appears in the display.

- 2 Press NAME EDIT/SELECT repeatedly to select the character type.**

Each time you press the button, the display changes cyclically as follows:

■ ■ ■ (Blank space) → “Selected ABC” (Upper cases or symbols¹⁾) → “Selected abc” (Lower cases or symbols¹⁾) → “Selected 123” (Numbers)

1) Only ' - / , . () : ! ? can be selected.

3 Enter a character using letter/number buttons.

If you have selected uppercase or lowercase letters

- 1 Press the corresponding letter/number button repeatedly until the character to be entered flashes.
Or, press the button once and press **◀◀/▶▶** repeatedly.
To select symbols, press **◀◀** repeatedly while "A" is flashing.
- 2 Press **▶▶**.
The flashing character is entered and lights continuously and the cursor shifts to the right.

If you have selected numbers

Press the corresponding number button.
The number is entered and the cursor shifts to the right.

4 Repeat steps 2 and 3 to enter the rest of the name.

To change a character

Press **◀◀/▶▶** repeatedly until the character to be changed flashes, press **CLEAR** to erase the character, then repeat steps 2 and 3.

5 Press YES.

The whole name appears in the display, followed by "Complete!!".

Copying a track or disc name

You can copy an existing track or disc name and use it to name another track on the same disc or the disc itself.

1 While the deck is stopped, playing, or paused, press MENU/NO.

"Edit Menu" appears in the display.

2 Turn AMS (or press ◀◀/▶▶ repeatedly) until "Name ?" appears, then press AMS or YES.

3 Turn AMS (or press ◀◀/▶▶ repeatedly) until "Nm Copy ?" appears, then press AMS or YES.

4 Turn AMS (or press ◀◀/▶▶ repeatedly) until the track number (when copying the track name) or "Disc" (when copying the disc name) flashes, then press AMS or YES to copy the selected name.

When "No Name" appears in the display

The selected track or disc has no name.

5 Turn AMS (or press ◀◀/▶▶ repeatedly) until the track number (when naming a track) or "Disc" (when naming a disc) flashes, then press AMS or YES to enter the copied name.

"Complete!!" appears.

Tip

When "Overwrite ??" appears in step 5 above, the track or the disc selected in step 5 already has a name. If you wish to replace the name, press **AMS** or **YES** again while the indication appears in the display. If the track has been recorded in MD LP mode with the "LPstamp On" setting (page 10), "Overwrite ??" also appears even if a track name is not assigned. In this case if you copy the track name, the "LP:" indication disappears from the track name.

Renaming a track or MD

1 Press NAME EDIT/SELECT on the remote while the deck is in one of the operating modes listed below, depending on what you want to rename:

To rename	Press while
A track	The track number is displayed
The MD	The deck is stopped with total number of tracks displayed

A track or disc name appears in the display.

2 Press CLEAR until the selected name is erased completely.

3 Do steps 5 to 8 of "Naming a track or an MD using the controls on the deck" on page 24 or steps 2 to 4 of "Naming a track or an MD using the remote" on page 24.

4 Press YES.

The whole name appears in the display, followed by "Complete!!".

continued

Naming a track or MD (continued)

Erasing a track or disc name

Use this function to erase the name of a track or disc.

- 1 While the deck is stopped, playing, recording, or paused, press MENU/NO. “Edit Menu” appears in the display.
- 2 Turn AMS (or press ◀◀/▶▶ repeatedly) until “Name ?” appears, then press AMS or YES.
- 3 Turn AMS (or press ◀◀/▶▶ repeatedly) until “Nm Erase ?” appears, then press AMS or YES.
- 4 Turn AMS (or press ◀◀/▶▶ repeatedly) until the number of the track (when erasing the track name) or “Disc” (when erasing the disc name) flashes, then press AMS or YES. “Complete!!” appears.

To erase all the names on the MD

Select “Nm All Ers?”, then press AMS or YES twice in step 3 above.

Changing the recorded level after recording

— S.F EDIT

You can change the volume of recorded tracks using S.F (Scale Factor) Edit. The original track is recorded over at the new recording level. When changing the recording level, you can select Fade-in Recording to gradually increase the signal level at the start of recording, or Fade-out Recording to gradually decrease the signal level at the end of recording.

Changing the overall recording level

- 1 Press MENU/NO. “Edit Menu” appears in the display.
- 2 Turn AMS (or press ◀◀/▶▶ repeatedly) until “S.F Edit?” appears, then press AMS or YES.
- 3 Turn AMS (or press ◀◀/▶▶ repeatedly) until “Tr Level ?” appears, then press AMS or YES.
- 4 Turn AMS (or press ◀◀/▶▶ repeatedly) until the track number you want to change the recording level appears, then press AMS or YES. “Level 0dB” appears in the display.
- 5 While monitoring the sound, turn AMS (or press ◀◀/▶▶ repeatedly) to change the recorded level without turning on “OVER” on the peak level meters.



Avoid turning on these indicators

6 Press AMS or YES.

“S.F Edit OK?” appears in the display.

7 Press AMS or YES.

The deck starts recording over the existing track. “S.F Edit(:) ** %” appears while the track is being recorded. An amount of time that is roughly equal to or longer than the playback time of the track is required when recording over the track. When the recording finishes, “Complete!!” appears.

Fade-in and Fade-out Recording

1 Press MENU/NO.

“Edit Menu” appears in the display.

2 Turn AMS (or press ◀◀/▶▶ repeatedly) until “S.F Edit?” appears, then press AMS or YES.**3 Turn AMS (or press ◀◀/▶▶ repeatedly) until “Fade In ?” or “Fade Out ?” appears, then press AMS or YES.****4 Turn AMS (or press ◀◀/▶▶ repeatedly) until the track number you want to change the recording level appears, then press AMS or YES.**

“Time 5.0s” appears in the display.

5 While monitoring the sound, turn AMS (or press ◀◀/▶▶ repeatedly) to change the Fade-in or Fade-out Recording time.

The deck plays the portion that will be recorded over using Fade-in or Fade-out Recording.

You can set the time at any value between 1 second and 15 seconds, in 0.1 second increments. You cannot set the time longer than the track.

6 Press AMS or YES.

“S.F Edit OK?” appears in the display.

7 Press AMS or YES.

The deck starts recording over the existing track. “S.F Edit(:) ** %” appears while the track is being recorded. When the recording finishes, “Complete!!” appears.

To cancel the operation

Press MENU/NO or ■ in steps 1 to 6. If you press AMS or YES in step 7 and recording starts, you cannot interrupt the operation.

Notes

- **Do not disconnect the AC power cord or move the deck while recording is in progress. This may damage the recording data preventing recording from being performed properly.**
- You cannot change the recorded level of a track recorded in LP2 or LP4 Stereo mode.
- Do not use an MD that is damaged or dirty. This may prevent recording data from being recorded properly.
- Repeatedly changing the recording level results in poor sound quality.
- The recording level will not return to the exact original level once the recording level has been changed even if it returned to the original level.
- The recording level cannot be changed while the timer is activated.
- You cannot undo any S.F edit operation with the Undo Function.

Undoing the last edit

— UNDO

You can undo the last edit operation and restore the contents of the MD to the condition that existed before the operation. Note, however, that you cannot undo an edit operation if you perform any of the following operations after the edit:

- Start recording.
- Press MUSIC SYNC on the remote.
- Change the recorded level after recording (S.F Edit).
- Turn off the deck or eject the MD.
- Disconnect the AC power cord.

1 While the deck is stopped, press MENU/NO.

“Edit Menu” appears in the display.

2 Turn AMS (or press ◀◀/▶▶) repeatedly until “Undo ?” appears.

“Undo ?” does not appear if no editing has been done.

3 Press AMS or YES.

One of the messages appears depending on the last edit operation.

4 Press AMS or YES.

“Complete!!” appears.

Fading in and fading out

You can use Fade-in Play to gradually increase the signal level to the ANALOG OUT jacks and the PHONES jack at the start of playing. Fade-out Play gradually decreases the signal level at the end of playing.

Fade-in Recording gradually increases the signal level at the start of recording. Fade-out Recording gradually decreases the signal level at the end of recording.

Fade-in Play and Fade-in Recording

During play pause (for Fade-in Play) or recording pause (for Fade-in Recording), press FADER on the remote.

◀ flashes in the display and the deck performs Fade-in Play or Fade-in Recording for five seconds (factory setting) until the counter reaches “0.0s.”

Fade-out Play and Fade-out Recording

During play (for Fade-out Play) or recording (for Fade-out Recording), press FADER on the remote.

▶ flashes in the display and the deck performs Fade-out Play or Fade-out Recording for five seconds (factory setting) until the counter reaches “0.0s,” then pauses.

Tip

Do the following procedure to specify the fade-in or fade-out duration for playback or recording.

- 1 While the deck is stopped, press MENU/NO twice.

“Setup Menu” appears in the display.

- 2 Turn AMS (or press ◀◀/▶▶ repeatedly) to select the setting, then press AMS or YES.

To change the duration of	Select
Fade-in Play/Recording	F.in
Fade-out Play/Recording	F.out

- 3 Turn AMS (or press ◀◀/▶▶ repeatedly) to select the duration, then press AMS or YES.

Both the Fade-in and Fade-out durations can be set in 0.1 second steps.

- 4 Press MENU/NO.

Falling asleep to music

— Sleep Timer

You can set the deck so that it turns off automatically after 60 minutes.

- 1 While the deck is stopped, press MENU/NO twice.

“Setup Menu” appears in the display.

- 2 Turn AMS (or press ◀◀/▶▶ repeatedly) until “Sleep Off” appears in the display, then press AMS or YES.

- 3 Turn AMS (or press ◀◀/▶▶ repeatedly) to select the setting, then press AMS or YES.

To	Select
Turn on Sleep Timer	Sleep On
Turn off Sleep Timer	Sleep Off (factory setting)

- 4 Press MENU/NO.

Tip

You can check the remaining time.

Once you turn on Sleep Timer, the remaining time is displayed when you select “Sleep” in Setup Menu.

Precautions

On safety

- Should any solid object or liquid fall into the cabinet, unplug the deck and have it checked by qualified personnel before operating it any further.
- Caution – The use of optical instruments with this product will increase eye hazard.

On power sources

- Before operating the deck, check that the operating voltage of the deck is identical with your local power supply. The operating voltage is indicated on the nameplate at the rear of the deck.
- The unit is not disconnected from the AC power source (mains) as long as it is connected to the wall outlet, even if the unit itself has been turned off.
- If you are not going to use the deck for a long time, be sure to disconnect the deck from the wall outlet. To disconnect the AC power cord, grasp the plug itself; never pull the cord.
- AC power cord must be changed only at the qualified service shop.

On condensation in the deck

If the deck is brought directly from a cold to a warm location, or is placed in a very damp room, moisture may condense on the lenses inside the deck. Should this occur, the deck may not operate properly. In this case, remove the MD and leave the deck turned on for several hours until the moisture evaporates.

On cleaning

Clean the cabinet, panel and controls with a soft cloth slightly moistened with a mild detergent solution. Do not use any type of abrasive pad, scouring powder or solvent such as alcohol or benzene.

If you have any questions or problems concerning your deck, please consult your nearest Sony dealer.

Note on MDs

- Do not touch the internal disc directly. Forcing the shutter open may damage the internal disc.
- Be sure to stick the labels supplied with the MD to the appropriate positions. The shape of the labels may vary depending on the MD brand.

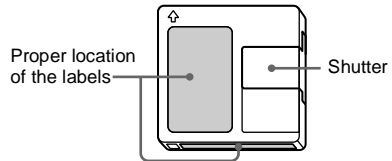

Where to keep the MDs

Do not place the cartridge where it may be exposed to direct sunlight or extremely high heat and humidity.

Regular maintenance

Wipe dust and debris from the surface of the cartridge with a dry cloth.

System limitations

The recording system in your deck is radically different from those used in cassette and DAT decks and is characterized by the limitations described below. Note, however, that these limitations are due to the inherent nature of the MD recording system itself and not to mechanical causes.

“Disc Full” appears in the display even before the MD has reached the maximum recording time

When 255 tracks have been recorded to the MD, “Disc Full” appears regardless of the total recorded time. More than 255 tracks cannot be recorded to the MD. To continue recording, erase unnecessary tracks or use another recordable MD.

“Disc Full” appears before the maximum number of tracks is reached

Fluctuations in emphasis within tracks are sometimes interpreted as track intervals, incrementing the track count and causing “Disc Full” to appear.

The remaining recording time does not increase even after erasing numerous short tracks

Tracks under 12 seconds¹⁾ in length are not counted and so erasing them may not lead to an increase in the recording time.

Some tracks cannot be combined with others

Tracks may not be combined if they have been edited.

The total recorded time and the remaining recordable time on the MD may not total the maximum recording time

Recording is done in minimum units of two seconds¹⁾ each, no matter how short the material is. The contents recorded may thus be shorter than the maximum recording capacity. Disc space may also be further reduced by scratches.

- 1) During stereo recording.
In MONO or LP2 mode: about 4 seconds
In LP4 mode: about 8 seconds

Limitations when recording over an existing track

- The correct remaining recordable time may not be displayed.
- You may find it impossible to record over a track if that track has been recorded over several times already. If this happens, erase the track (see page 19).
- The remaining recordable time may be shortened out of proportion to the total recorded time.
- Recording over a track to eliminate noise is not recommended since this may shorten the duration of the track.
- You may find it impossible to name a track while recording over an existing track.

Tracks created through editing may exhibit sound dropout as you are searching for a point while monitoring the sound.

Track numbers are not marked correctly

Incorrect assignment or marking of track numbers may result when CD tracks are divided into several smaller tracks during digital recording. Also, when the Automatic Track Marking is activated during recording, track numbers may not be marked as in the original, depending on the program source.

The correct recorded/playing time may not be displayed during play of MDs recorded in monaural mode.

Guide to the Serial Copy Management System

Digital audio components, such as CDs, MDs, and DATs, make it easy to produce high-quality copies of music by processing music as a digital signal.

To protect copyrighted music sources, this deck uses the Serial Copy Management System, which allows you to make only a single copy of a digitally recorded source through digital-to-digital connections.

continued

System limitations (continued)

You can make only a first-generation copy²⁾ through a digital-to-digital connection.

Examples are as follows:

- You can make a copy of a commercially available digital sound program (for example, a CD or MD), but you cannot make a second copy from the first-generation copy.
 - You can make a copy of a digital signal from a digitally recorded analog sound program (for example, an analog record or a music cassette tape) or from a digital satellite broadcast program, but you cannot make a second copy from the first-generation copy.
- 2) A first-generation copy means the first recording of a digital audio source through the deck's digital input connector. For example, if you record from a CD player connected to the DIGITAL IN connector, that copy is a first-generation copy.

Note

The restrictions of the Serial Copy Management System do not apply when you make a recording through the analog-to-analog connections.

Troubleshooting

If you experience any of the following difficulties while using the deck, use this troubleshooting guide to help you remedy the problem. Should any problem persist, consult your nearest Sony dealer.

The deck does not operate or operates poorly.

The MD may be dirty or damaged. Replace the MD.

Only the following buttons are operable while the MD deck is being controlled by a personal computer.

I/⏻, INPUT, LEVEL/DISPLAY/CHAR (DISPLAY, SCROLL, LEVEL +/- on the remote).

The deck does not play.

- Moisture has formed inside the deck. Take the MD out and leave the deck in a warm place for several hours until the moisture evaporates.
- The deck is not on. Press I/⏻ to turn on the deck.
- The deck may not be connected to the amplifier correctly. Check the connection (page 6).
- The MD is inserted in the wrong direction. Slide the MD into the disc slot with the label side up and the arrow pointing toward the slot (page 16).
- The MD may not be recorded. Replace the disc with one that has been recorded.

The sound has a lot of static.

Strong magnetism from a television or a similar device is interfering with operations. Move the deck away from the source of strong magnetism.

The deck does not record.

- The deck is not connected properly to the program source. Check the connection (page 6).
- Select the correct program source using INPUT.
- The recording level is not adjusted properly. Adjust the recording level (page 12).
- A premastered MD is inserted. Replace it with a recordable MD.
- There is not enough time left on the MD. Replace it with another recordable MD with fewer recorded tracks, or erase unnecessary tracks (page 19).
- There has been a power failure or the AC power cord has been disconnected during recording. Data recorded to that point may be lost. Repeat the recording procedure.

The deck does not perform Synchro-recording with a CD player or video CD player.

The remote supplied with the MD deck is not set correctly. Reset the remote.

A message and a three- or five-digit alphanumeric code alternate in the display.

The Self-diagnosis function is on (page 33).

Note

If the deck does not operate properly even after you have attempted the prescribed remedies, turn off the deck, then re-insert the plug into the power outlet.

Self-diagnosis function

The deck's self-diagnosis function automatically checks the condition of the MD deck when an error occurs, then issues a three- or five-digit code and an error message on the display. If the code and message alternate, find them in the following table and perform the indicated countermeasure. Should the problem persist, consult your nearest Sony dealer.

C11/Protected

- ➔ Take out the MD and close the record-protect slot (page 9).

C12/Cannot Copy

- You tried to record a CD with a format that the external device connected to the deck does not support, such as CD-ROM or video CD.
 - ➔ Remove the disc and insert a music CD.

C13/REC Error

- ➔ Set the deck in a stable surface, and repeat the recording procedure.
- The inserted MD is dirty (with smudges, fingerprints, etc.), scratched, or substandard in quality.
 - ➔ Replace the disc and repeat the recording procedure.

C13/Read Error

- ➔ Take out the MD and insert it again.

C14/TOC Error

- ➔ Insert another disc.
- ➔ If possible, erase all the tracks on the MD (page 20).

C41/Cannot Copy

- The sound source is a copy of commercially available music software, or you tried to record a CD-R (Recordable CD).
 - ➔ The Serial Copy Management System prevents making a digital copy (page 31). You cannot record a CD-R.

C71/Din Unlock

- The sporadic appearance of this message is caused by the digital signal being recorded. This will not affect the recording.
 - While recording from a digital component connected through the DIGITAL IN connector, the digital connecting cable was unplugged or the digital component turned off.
 - ➔ Connect the cable or turn the digital component back on.
-

Display messages

The following table explains the various messages that appear in the display. Messages are also displayed by the deck's Self-diagnosis function (see page 33).

Auto Cut

The Auto Cut Function is on (page 11).

Blank Disc

A new (blank) or erased MD has been inserted.

Cannot Copy

An attempt was made to make a second copy from a digitally dubbed MD (page 31).

Cannot Edit

An attempt was made to edit a premastered MD, to edit the MD during Program or Shuffle Play or to change the recording level of an MD recorded in LP2 or LP4 Stereo mode.

Disc Full

The MD is full (page 31).

Impossible

The deck cannot do the specified operation (pages 8, 21 and 23).

Incomplete!!

The S.F Edit (changing the recording level after recording, Fade-in, Fade-out) operation was not performed properly because the deck was moved while recording was in progress or the MD is damaged or dirty.

Initialize (flashing)

The Setup Menu settings have been lost. Or the contents recorded by the timer have disappeared over time and are not be available for saving to disc, or Program Play could not be activated since the program has disappeared over time.
(The message flashes for about four seconds when you turn on the deck by pressing I/⏻.)

Name Full

The naming capacity of the MD has reached its limit (about 1,700 characters).

No Change

While attempting to change the recording level after recording, you pressed YES without actually changing the recording level, so no change was made.

continued

Display messages (continued)

No Disc

There is no MD in the deck.

No Name

The track or disc has no name.

ProgramFull!

The program contains the maximum number of tracks. You cannot add any more tracks.

REMOTE

The MD is being controlled by an external device connected to the deck.¹⁾

S.F Edit!

You attempted to perform another operation while in S.F Edit (changing the recording level after recording, Fade-in, Fade-out) mode.

You cannot perform any other operations while in S.F Edit mode.

S.F Edit NOW

You pressed I/⏪ while in S.F Edit (changing the recording level after recording, Fade-in, Fade-out) mode.

If you turn off the deck while in S.F Edit mode, any changes that you have made will not be made properly. Finish the changes and leave S.F Edit mode before turning off the deck. If you accidentally turn off the deck while changes are being made, press I/⏪ while the message is displayed.

Smart Space

The Smart Space Function is on (page 11).

TOC Reading

The deck is checking the TOC (Table Of Contents) on the MD.

- 1) If "REMOTE" appears under other circumstances, turn off the deck, then turn it on again.

Setup menu table

Menu item	Reference page
Program?	18
T.Mark	10
LS(T)	11
S.Space	12
P.Hold	12
F.in	29
F.out	29
Sleep	29
LPstamp	10

Specifications

System	MiniDisc digital audio system
Disc	MiniDisc
Laser	Semiconductor laser ($\lambda = 780 \text{ nm}$) Emission duration: continuous
Laser output	MAX 44.6 $\mu\text{W}^{1)}$
1)	This output is the value measured at a distance of 200 mm from the objective lens surface on the Optical Pick-up Block with 7 mm aperture.
Laser diode	Material: GaAlAs
Revolutions (CLV)	400 rpm to 900 rpm
Error correction	ACIRC (Advanced Cross Interleave Reed Solomon Code)
Sampling frequency	44.1 kHz
Coding	ATrac (Adaptive TRansform Acoustic Coding)/ATRAC 3
Modulation system	EFM (Eight-to-Fourteen Modulation)
Number of channels	2 stereo channels
Frequency response	5 to 20,000 Hz $\pm 0.3 \text{ dB}$
Signal-to-noise ratio	Over 94 dB during play
Wow and flutter	Below measurable limit
Inputs	
ANALOG IN	Jack type: phono Impedance: 47 kilohms Rated input: 500 mVrms Minimum input: 125 mVrms
DIGITAL IN	Connector type: square optical Impedance: 660 nm (optical wave length)

Outputs

PHONES

Jack type: stereo phone
Rated output: 10 mW
Load impedance: 32 ohms
Jack type: phono
Rated output: 2 Vrms (at 50 kilohms)
Load impedance: over 10 kilohms

ANALOG OUT

General

Power requirements

U.S.A. and Canadian models:

120 V AC, 60Hz

European models:

230 V AC, 50/60Hz

Australian models:

240 V AC, 50/60Hz

Hong Kong models:

220-240 V AC, 50/60Hz

Other models:

110-120/220-240 V AC,
50/60Hz

Adjustable with voltage
selector

Power consumption

15 W

0.5 W (in the STANDBY
mode)

Dimensions (approx.)

280 × 84.5 × 290 mm (w/
h/d) incl. projecting parts
and controls

Mass (approx.)

2.4 kg

Supplied accessories

Audio connecting cords (2)

Optical cable (1)

Remote commander (remote) (1)

R6 (size-AA) batteries (2)

US and foreign patents licensed from Dolby
Laboratories.

Design and specifications are subject to change
without notice.

Using the beeps

(Except for North American model)

The deck can output various beeps that allow you to identify deck operations by sound. The beeps are output from the LINE (ANALOG) OUT jacks.

Set BEEP (located at the rear panel of the deck) to ON.

Beeps are output according to the deck status as follows:

One short beep (high)

The deck has been turned on, started playing, started recording,¹⁾ etc.

Two short beep (high)

The deck has been turned off.

One short beep (low)

- The deck has stopped or the MD has been ejected.
- Menu operation has finished or canceled, normal play mode has been resumed, recording level has been set to 0 dB (default value) (i.e., the deck has resumed the normal status).

The peak level meter is displayed.

Several beeps (low and high beeps are output alternately)

The deck's self diagnosis function has been activated and a code and message alternate in the display.

Consecutive beeps (high)

- An operation button was pressed with no MD inserted.
- You cannot select an item or setting value by turning AMS (or pressing ◀▶ repeatedly).
- The remaining recordable time becomes less than 3 minutes during recording.¹⁾

Consecutive beeps (low)

- The recording level or trigger level for Automatic Track Marking has been set to maximum or minimum.
- You cannot select an item or setting value by turning AMS (or pressing ◀▶ repeatedly).

One continuous beep (high)

- was pressed but the MD is full.

continued

Using the beeps (continued)

One continuous beep (low)

- During recording or recording pause, the peak level meters have exceeded the recommended level (“OVER” lights up).¹⁾
- You cannot change the play mode.

Consecutive short beeps (low)²⁾
followed by single short beeps (low)
every few seconds

The deck has changed to recording pause.

- 1) The beep has no effect on recording results.
- 2) One low beep for each 10 minutes of remaining recordable time (e.g., one beep for 11 to 20 minutes, two beeps for 21 to 30 minutes, and three beeps for 31 to 40 minutes). No beep is output for a remaining time of 10 minutes or less.

To turn off the beeps

Set BEEP to OFF.

Note

If you press SCROLL while BEEP is set to ON and no MD is inserted, a beep is emitted and the status of the following items automatically changes as follows:

- Shuffle Play or Program Play is canceled and normal play is resumed.
- Repeat All Play or Repeat 1 Play is canceled.
- The recording mode is set to stereo mode.
- ANALOG IN is selected.