

SONY.

3-864-822-11(1)

Mini Hi-Fi Component System

Operating Instructions

Owner's Record

The model and serial numbers are located at the rear of the unit. Record these numbers in the spaces provided below. Refer to them whenever you call upon your Sony dealer regarding this product.

Model No. _____ Serial No. _____



DHC-MD555

©1998 by Sony Corporation

WARNING

To prevent fire or shock hazard, do not expose the unit to rain or moisture.

To avoid electrical shock, do not open the cabinet. Refer servicing to qualified personnel only.

Do not install the appliance in a confined space, such as a bookcase or built-in cabinet.

US and foreign patents licensed from Dolby Laboratories Licensing Corporation.

Laser component in this product is capable of emitting radiation exceeding the limit for Class 1.

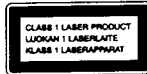

This appliance is classified as a CLASS 1 LASER product. The CLASS 1 LASER PRODUCT MARKING is located on the rear exterior.

The following caution label is located inside the unit.

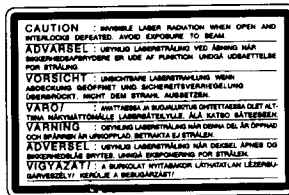

AR46

IN NO EVENT SHALL SELLER BE LIABLE FOR ANY DIRECT, INCIDENTAL OR CONSEQUENTIAL DAMAGES OF ANY NATURE, OR LOSSES OR EXPENSES RESULTING FROM ANY DEFECTIVE PRODUCT OR THE USE OF ANY PRODUCT.

NOTICE FOR THE CUSTOMERS IN THE U.S.A.



This symbol is intended to alert the user to the presence of uninsulated "dangerous voltage" within the product's enclosure that may be of sufficient magnitude to constitute a risk of electric shock to persons.



This symbol is intended to alert the user to the presence of important operating and maintenance (servicing) instructions in the literature accompanying the appliance.

CAUTION

The use of optical instruments with this product will increase eye hazard.

INFORMATION

This equipment has been tested and found to comply with the limits for a Class B digital device, pursuant to Part 15 of the FCC Rules. These limits are designed to provide reasonable protection against harmful interference in a residential installation. This equipment generates, uses, and can radiate radio frequency energy and, if not installed and used in accordance with the instructions, may cause harmful interference to radio communications. However, there is no guarantee that interference will not occur in a particular installation. If this equipment does cause harmful interference to radio or television reception, which can be determined by turning the equipment off and on, the user is encouraged to try to correct the interference by one or more of the following measures:

- Reorient or relocate the receiving antenna.
- Increase the separation between the equipment and receiver.
- Connect the equipment into an outlet on a circuit different from that to which the receiver is connected.
- Consult the dealer or an experienced radio/TV technician for help.

CAUTION

You are cautioned that any changes or modifications not expressly approved in this manual could void your authority to operate this equipment.

Note to CATV system installer:

This reminder is provided to call the CATV system installer's attention to Article 820-40 of the NEC that provides guidelines for proper grounding and, in particular, specifies that the cable ground shall be connected to the grounding system of the building, as close to the point of cable entry as practical.

Table of Contents

Getting Started

Step 1: Hooking up the system	4
Step 2: Setting the time	8
Step 3: Presetting radio stations	10

Features of the DHC-MD555 ... 12

Basic Operations

Playing a CD	14
Recording a CD on an MD	16
Playing an MD	18
Listening to the radio	21
Recording from the radio	23

Listening to a CD/MD

Listening to tracks in a different order	25
Playing tracks repeatedly	29
Shortening the silence while changing the discs	29
Using the display	30
Labeling a CD	31
Checking CD text information	34

Recording on an MD

Before you start recording	35
Types of recording	36

Recording a CD

Recording your favorite tracks	37
Recording multiple CDs in succession on multiple MDs	39
Recording only the first track	41
Recording the current track	42
Recording your favorite portions	43
Making the space between tracks 3 seconds long	44

Recording from the Radio

Starting recording with 6 seconds of prestored audio data	45
Marking track numbers	46
Adjusting the recording level	48
Monaural recording	49

Editing an MD

Before you start editing	50
--------------------------------	----

Labeling an MD	51
Erasing recordings	53
Moving recorded tracks	57
Dividing recorded tracks	58
Combining recorded tracks	59
Undoing the last edit	61

Adjusting the Sound

Getting a more powerful sound	62
Selecting a sound effect	62

Timer

Falling asleep to music	63
Waking up to music	64
Timer-recording radio programs	66

Other Features

Labeling the preset stations	69
Using the Radio Data System (RDS)* ..	71

Using Optional Equipment

List of compatible components	74
-------------------------------------	----

MD WALKMAN**

Connecting an MD WALKMAN	75
Recording from an MD WALKMAN ..	76

Other A/V Components

Connecting a tape deck, VCR, etc.	78
Listening to the sound of connected A/V components	79
Recording the sound of connected A/V components	80

FM/AM Antenna

Connecting commercially available antennas	81
--	----

Additional Information

Precautions	82
System limitations of MDs	83
Troubleshooting	85
Self-diagnosis display function	93
Display messages	94
Specifications	97
Index	99

* European model only

** "MD WALKMAN" is a trademark of Sony Corporation.

Getting Started

Step 1: Hooking up the system

Perform the following procedure **1** to **5** to hook up your system using the supplied cords and accessories.
The supplied antennas are for indoor use. We recommend connecting a commercially available antenna to ensure stable reception.
See pages 74 – 81 for connecting outdoor antennas and other optional equipment.

Preparation

Pull the transport cartridge straight toward you out of the MD deck.

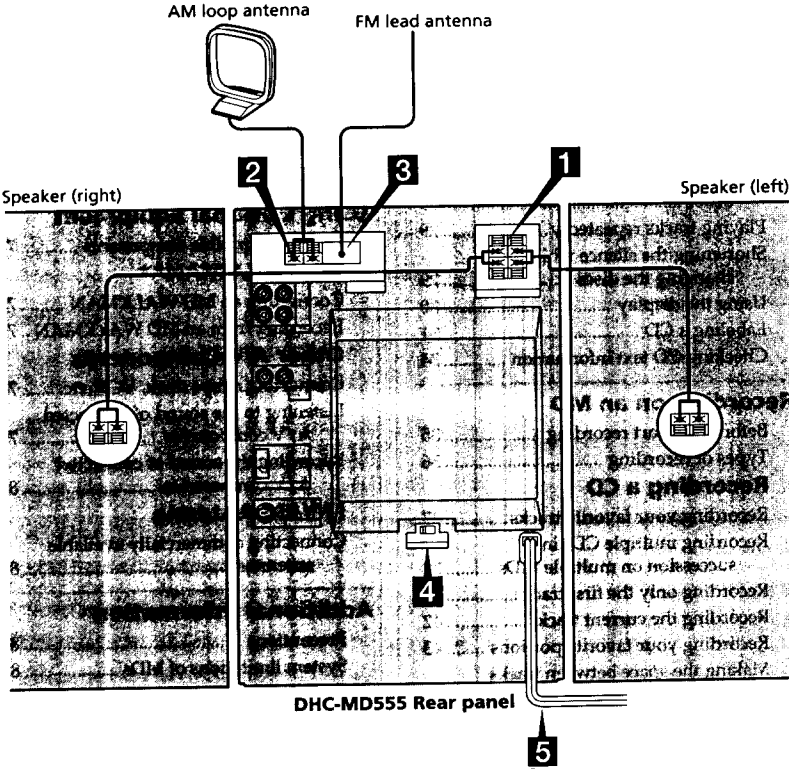

Preparation

Pull the transport cartridge straight toward you out of the MD deck.

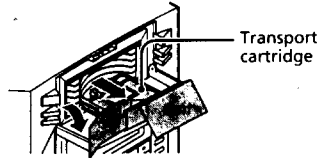

Tip

Keep the transport cartridge for future use. When you move the system, insert the cartridge into the MD 4 slot of the MD deck in the same manner as when you purchased the system to prevent deck trouble (see page 82).

Note

Be sure to remove the transport cartridge before you turn on the system.

If you turn on the system without taking out the cartridge, "MD RE-INSERT!" appears. Turn off the system, then take out the cartridge.

1 Connect the speakers.

Position the speakers so that the SONY logo is on the inside. Viewed from the front of the system, connect the speaker on the left side to the SPEAKER L terminals, and the speaker on the right side to the SPEAKER R terminals.

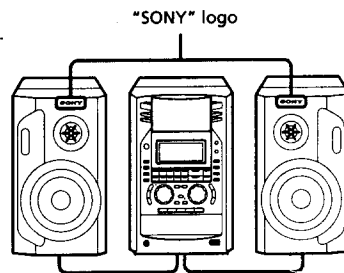

- 1 Connect the speaker cords to the SPEAKER terminals of the same color.

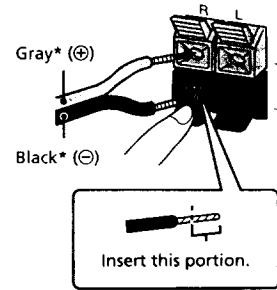

* The color of your speaker cords might be different. See the manual provided with your speaker system for details (except for the tourist model).

- 2 Pull gently on the speaker cord to make sure it is connected correctly. If the speaker cord pulls out, connect it again.

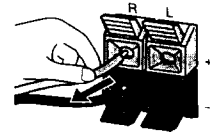

Notes

- Keep the speaker cords away from the antennas to prevent noise during radio reception.
- If you reverse the right and left speaker connections or the speaker positions, the sound may be strange.

Step 1: Hooking up the system (continued)

2 Connect the AM antenna.

Structure of the supplied AM antenna

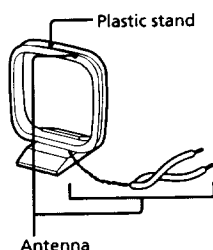

The antenna is the proper shape and length for receiving AM radio waves, so do not remove or roll up the antenna.

To set up the AM antenna

- 1 Remove only the twisted portion () of the antenna from the plastic stand.
- 2 Set up the stand. Open the stand,

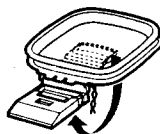

and fit the antenna into the groove.

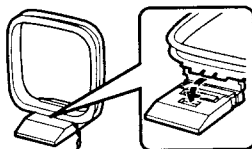

To connect the AM antenna

- 1 Insert the antenna cord into the AM antenna terminals.

Jack type (A)

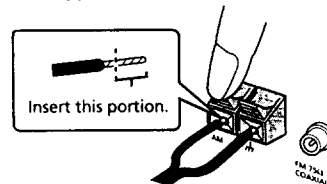

Jack type (B)

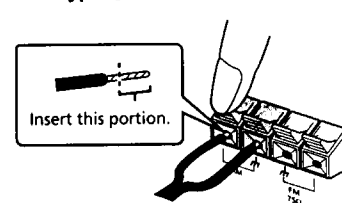

- 2 Pull gently on the antenna cord to make sure it is connected correctly. If the antenna cord pulls out, connect it again.

3 Connect the FM antenna.

Structure of the supplied FM lead antenna

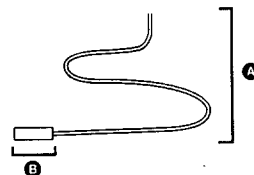

- (A) : The antenna cord receives signals along its entire length, so do not roll up the cord.
- (B) : Insert this portion into the antenna terminal.

To connect the FM antenna

- 1 Insert the antenna cord into the FM antenna terminal.

Jack type ④

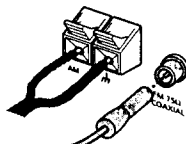

Jack type ⑥

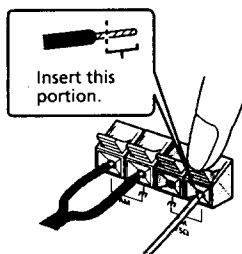

- 2 Pull gently on the antenna cord to make sure it is connected correctly. If the antenna cord pulls out, connect it again.

To extend the FM antenna

Tune in an FM station and fasten the antenna to a position that provides good reception.

- 4 Adjust the operating voltage (for models with a voltage selector). Before connecting the power cord, set **VOLTAGE SELECTOR** on the rear panel to the position of the local power line voltage.

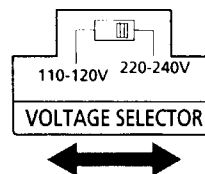

- 5 After finishing all speaker and antenna connections, connect the power cord to a wall outlet.

Plug Adapter (except for North American and European models)

If the plug of this system does not fit your wall outlet, attach the supplied adapter on to the plug.

When you connect the power cord, only the I/⏻ (power) indicator lights red.

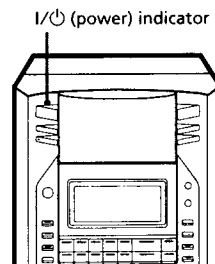

To display the clock at this time, see "Showing the time" on page 9.

**Step 1: Hooking up the system
(continued)**

**Inserting two R6 (size AA)
batteries into the remote**

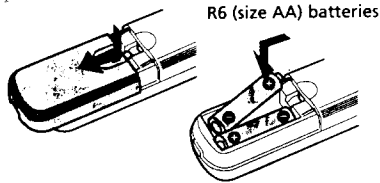

Always insert the batteries from the ⊖ end as shown in the illustration.

Tip

With normal use, the batteries should last for about six months. When the remote no longer operates the system, replace both batteries with new ones.

Note

If you do not use the remote for a long period of time, remove the batteries to avoid possible damage from battery leakage.

Step 2: Setting the time

You can set the time while the system is off. You must set the time beforehand to use the timer-recording and other timer functions. The clock is on a 24-hour system for the European model, and a 12-hour system for other models. The 12-hour system is used for illustration purposes.

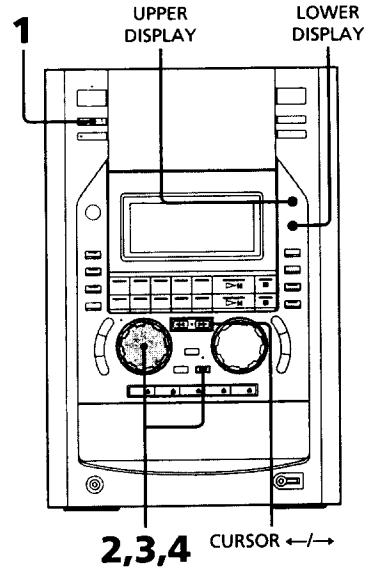

- 1 Press **CLOCK/TIMER SET**.
The time setting display appears, and the day indication "SUN" flashes.

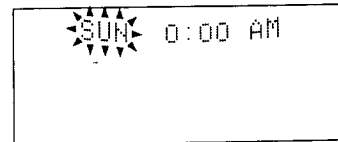

- 2** Turn MULTI JOG and set the day, then press ENTER/YES.
The hour indication flashes.
(For models using a 12-hour system, noon is indicated as 0:00 PM, and midnight as 0:00 AM.)



- 3** Turn MULTI JOG and set the hour, then press ENTER/YES.
The minute indication flashes.

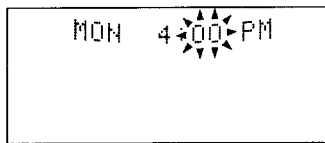

- 4** Turn MULTI JOG and set the minute, then press ENTER/YES.
The clock starts working, and the clock display disappears.

If you made a mistake

Press CURSOR ← or → until the indication you wish to change (day, hour, minute) flashes, then change the setting.

Showing the time

In order to conserve power, this system is set at the factory to not display the clock when the system is off (**Power Saving Mode**). To display the clock even when the system is off, press UPPER (or LOWER) DISPLAY while the system is off. Press the button again to turn the clock display off and activate the Power Saving Mode.

While the system is on, the information that appears at the top of the display changes as follows each time you press UPPER DISPLAY.

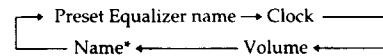

* Displayed only when disc title, track title, radio station name or other name information is labeled. No display when this information is not labeled.

Tip

The upper dot of the clock display flashes for the first half of a minute (0 to 29 seconds), and the lower dot flashes for the last half of a minute (30 to 59 seconds).

Changing the preset time

You can also set and change the time while the system is on.

- 1** Press CLOCK/TIMER SET.
- 2** Turn MULTI JOG until "CLOCK SET ?" appears.
- 3** Press ENTER/YES.
- 4** Perform steps 2 to 4 of "Setting the time".

Step 3: Presetting radio stations

You can preset the following number of stations:

- North American model: 20 for FM, and 10 for AM.
- European model: 20 for FM, 10 for MW, and 10 for LW.
- Other models: 20 for FM, 10 for MW, and 10 for SW.

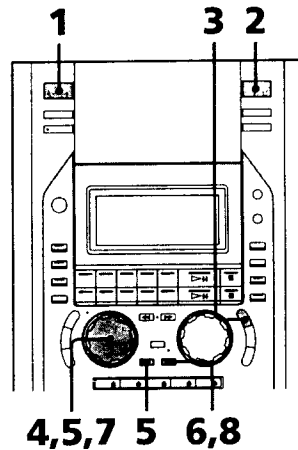

Tuning in a radio station you wish to preset

- 1 Press I/O (power) to turn on the system.

- 2 Press TUNER/BAND repeatedly until the band you want appears in the display.

Each time you press the button, the band changes as follows:

North American model:

→ FM → AM →

European model:

→ FM → MW → LW →

Other models:

→ FM → MW → SW →

- 3 Press TUNING MODE repeatedly until "AUTO" appears.

- 4 Turn MULTI JOG.

Turn MULTI JOG slightly, then release it. The frequency indication changes and scanning stops when the system tunes in a station. "TUNED" and "STEREO" (for a stereo program) appear.

If "TUNED" does not appear and the scanning does not stop

Press TUNING MODE repeatedly until "MANUAL" appears, then turn MULTI JOG to tune in the desired station.

To stop scanning

Press TUNING MODE.

Storing the radio station

- 5 Press MENU/NO, then turn MULTI JOG until "Memory?" appears.

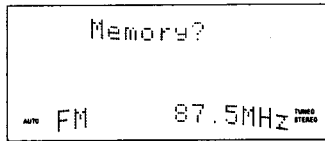

- 6 Press ENTER/YES. The preset number starts flashing. Perform steps 7 and 8 while the preset number is flashing. If no operations are performed for about 16 seconds, the preset number stops flashing and operation returns to the condition after completing step 4. In this case, start over from step 5.

- 7 Turn MULTI JOG and select the desired preset number.

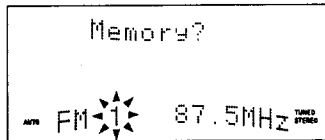

- 8 Press ENTER/YES. "Complete!!" appears, and the station is stored.
- 9 Repeat steps 2 to 8 to store other stations.

To change the preset number

Start over from step 2.

To change the AM/MW tuning interval (except for the European model)

The AM/MW tuning interval is factory-preset to 9 kHz (10 kHz in some areas). To change the AM/MW tuning interval, tune in any AM/MW station first, then turn off the system. While holding down the ENTER/YES button, turn the system back on. When you change the interval, all the preset stations will be erased. To reset the interval, repeat the same procedure.

To change the LW tuning interval (European model only)

The LW tuning interval is factory-preset to 3 kHz. To change the LW tuning interval, tune in any LW station first, then turn off the system. While holding down the ENTER/YES button, turn the system back on. When you change the interval, all the preset stations will be erased. To reset the interval, repeat the same procedure.

Tips

- The preset stations are retained for about a day even if you pull out the power cord or if a power interruption occurs.
- You can label the preset stations (see page 69).

► Features of the DHC-MD555

Features of the DHC-MD555

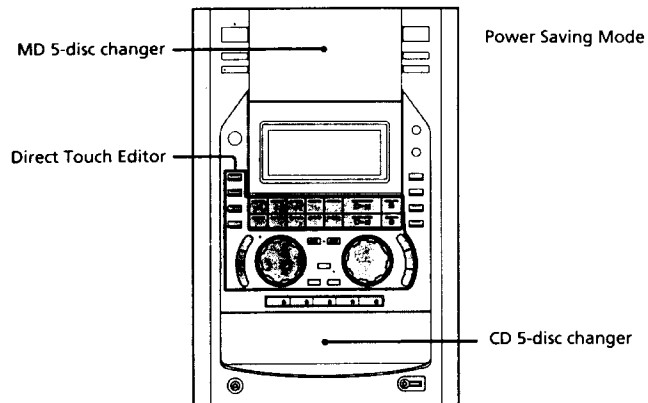

MD 5-disc changer with various recording functions

You can record continuously on up to 5 MDs. In addition, the centralized control panel lets you easily select the desired MD for either playing or recording.

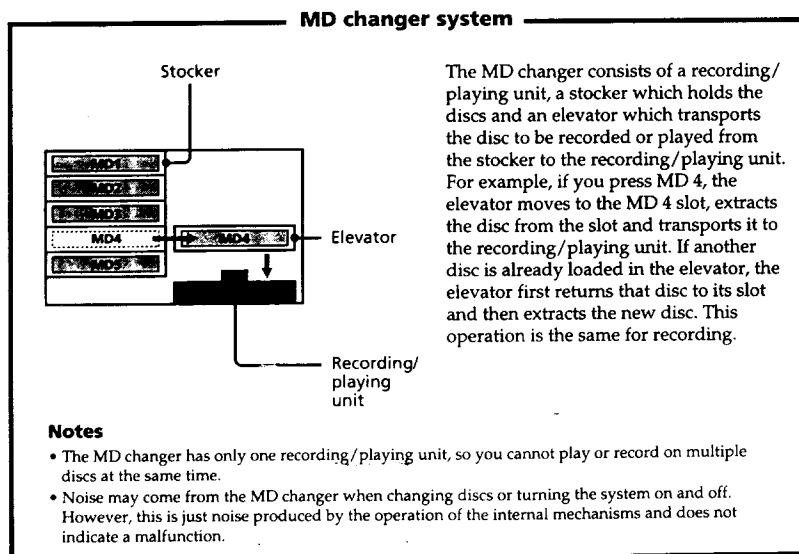

Easy-to-use, direct touch editor

The recording, editing and other control buttons are featured in a centralized layout by type of operation, making operation simple and easy.

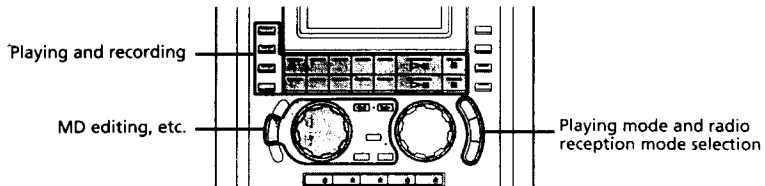

Power Saving Mode saves power when not using the system

The DHC-MD555 has a function which reduces the power consumed (e.g., used to receive remote signals or operate the clock) when the system is off.

CD 5-disc changer with EXCHANGE mechanism

You can change other discs while playing a CD (EXCHANGE mechanism). In addition, The centralized control panel lets you easily program and play the desired tracks from up to 5 CDs.

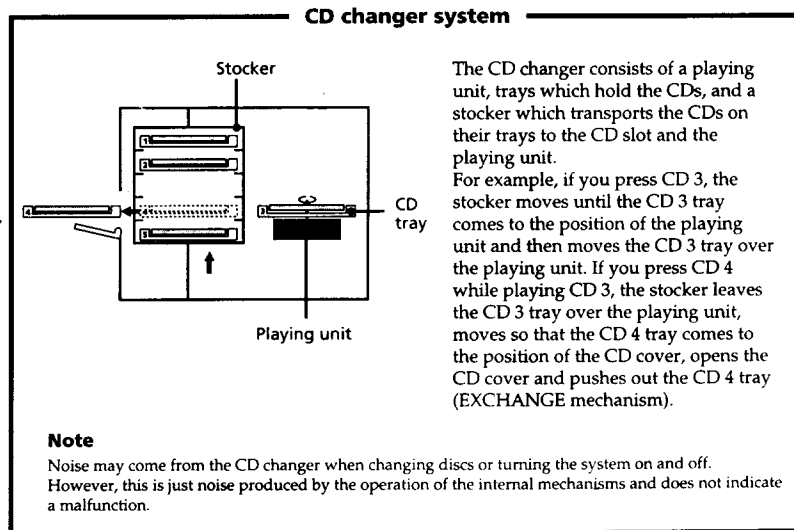

Basic Operations

Playing a CD

You can play up to 5 CDs in a row.
If the power is off, first press I/⏻ (power) to turn on the system.

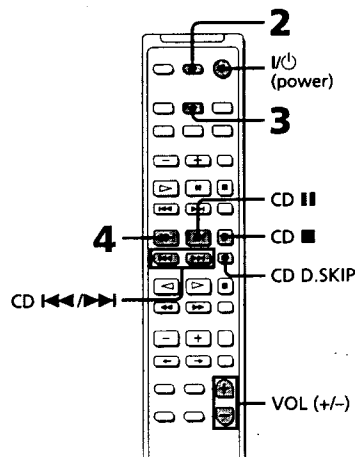
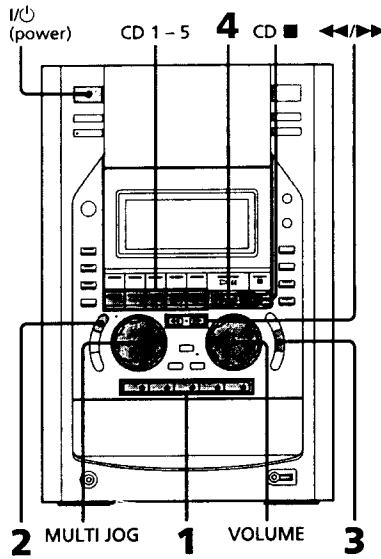

- 1 Press any CD 1 - 5 ▲ and place a CD on the disc tray.
The disc tray opens.

With the label side up. When you play a single CD, place it on the inner circle of the tray.

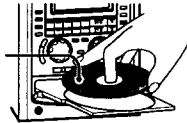

Press the same ▲ again to close the tray. To load other CDs, press a different ▲ and place the CD in the disc tray.

- 2 Press FUNCTION repeatedly to switch the function to CD.

- 3 Press 1/ALL repeatedly to select playing of either ALL DISCS or 1DISC.

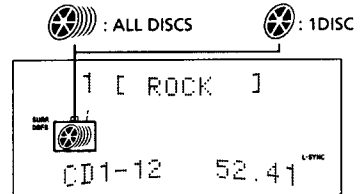

- 4 Press ▷|| for the CD (or CD ▷ on the remote).

The ▷|| button lights green, and play starts from the CD whose CD 1 - 5 button is lit green.

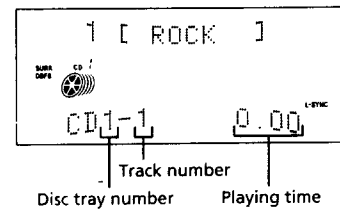

To start play from a different CD or to play only one CD, press CD 1 - 5 for the tray containing the desired disc. Play starts from the CD whose button was pressed.

To	Do this
Stop play	Press ■ for the CD.
Pause	Press ▷ for the CD (or CD on the remote). The light on the ▷ button changes from green to orange. Press again to resume play.
Select a track	Turn MULTI JOG clockwise (to go forward) or counter-clockwise (to go back) and release it when you locate the desired track (or press CD ►► or ◄◄ on the remote repeatedly).
Find a point in a track	Keep pressing ◄◄ or ►► during play and release it at the desired point. "—OVER—" appears at the end of the CD.
Select a CD	<ul style="list-style-type: none"> Press CD 1 - 5. Play starts when the button is pressed. Press CD D.SKIP on the remote repeatedly so that the CD 1 - 5 button is lit green. Press ▷ for the CD (or CD ▷ on the remote) to play the selected CD. If you press CD 1 - 5 (or CD D.SKIP on the remote) during play, the selected CD changes and the new CD starts playing.
Remove a CD	Press one of CD 1 - 5 ▲ to open the tray that contains the CD you want to remove.

To	Do this
Change other CDs while playing a CD	Press one of CD 1 - 5 ▲ to open the tray that contains the CD you want to change. When you have changed the CD, press the same button to close the tray. While the tray is open, the CD 1 - 5 button indicator for that tray flashes orange.
Adjust the volume	Turn VOLUME (or press VOL + or - on the remote).

Note

Do not forcibly press the disc tray closed with your finger, as this may cause CD player trouble. Always close the tray by pressing the CD 1 - 5 ▲ for the tray.

Tips

- You can switch from another source to the CD player and start playing a CD just by pressing ▷|| for the CD (or CD ▷ on the remote) or CD 1 - 5 if a CD is loaded on the tray (**Automatic Source Selection**). However, if a CD is used in a program, play does not start even if you press CD 1 - 5.
- The CD 1 - 5 button indicators have the following meanings when lit,
 - Green: The disc tray is selected or the CD loaded on the tray is playing.
 - Orange: A CD is loaded on the tray. All of the CD 1 - 5 button indicators light orange at first, and then turn on/off if the system determines that a CD is not loaded after the CD tray is opened and closed, etc.
- If a CD is not loaded to any of CD 1 - 5, "No Disc" appears.
- You can also select and start playing a track in step 4.
 - Press CD D.SKIP on the remote and select the desired CD.
 - Turn MULTI JOG (or press CD ◄◄ or ►► on the remote) until the desired track number appears.
 - Press ▷|| for the CD (or CD ▷ on the remote).

Recording from the radio (continued)

3 Press TUNING MODE repeatedly until "PRESET" appears.

4 Turn MULTI JOG to tune in the desired preset station.
Or press PRESET (+/-) on the remote.

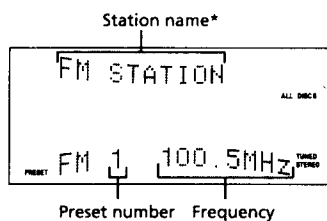

* The station name is displayed only when you have assigned a name to the preset station (see page 69).

5 Press REC MODE repeatedly until "1DISC" appears.

If you select "ALL DISCS", all loaded MDs are recorded in order from the MD in MD 1. Remove any unwanted MDs from the slots.

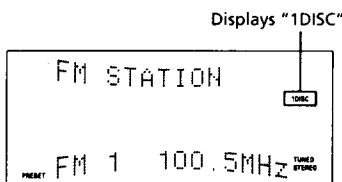

6 Press MD D.SKIP on the remote repeatedly so that the MD 1-5 button of the slot containing the recordable MD lights green.

7 Press REC.
The MD deck stands by for recording.

8 Press \triangleright II for the MD (or MD II on the remote).
Recording starts.

To stop recording

Press ■ for the MD.

Recording non-preset radio stations

- Press TUNING MODE repeatedly until "MANUAL" appears in step 3, then turn MULTI JOG to tune in the desired station. (**Manual Tuning**)
- Press TUNING MODE repeatedly until "AUTO" appears in step 3, then turn MULTI JOG slightly and release it. The frequency indication changes and scanning stops when the system tunes in a station. (**Automatic Tuning**)

To cancel Automatic Tuning

Press TUNING MODE.

Tips

- If the MD is partially recorded, recording starts after the recorded tracks. To erase recorded contents, see "Erasing recordings" on page 53.
- If you select "MONO" in step 5, the MD is recorded in monaural format. For details, see "Monaural recording" on page 49.
- You can adjust the recording level to the desired volume after performing step 7 (see page 48).
- If noise is heard while recording an AM (MW/LW or MW/SW) radio program, move the AM loop antenna to reduce the noise.

- 2** Insert a recordable MD to MD 1.
Open the MD cover, slide the disc into the MD 1 slot, and then close the cover.

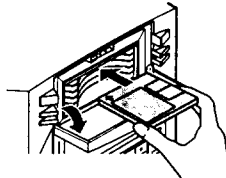

Inserting an MD

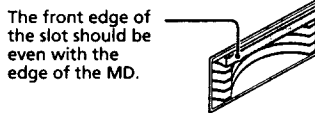
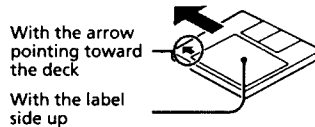

- 3** Press **FUNCTION** repeatedly to switch the function to CD.

Recording

- 4** Press **SELECT SYNC**.
"SELECT" appears, and the CD 1 - 5 buttons flash.
- 5** Press **CD 1**.
The CD 1 button lights green.
- 6** Press **MD 1**.
The MD 1 button lights green.

- 7** Press **ENTER/YES**.
The MD deck stands by for recording and the CD player is in pause for play.

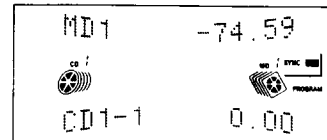

- 8** Press **▷||** for the MD (or **MD ||** on the remote).
Recording starts.
The CD player and the MD deck both stop when the recording is completed.

To cancel recording

Press **SELECT SYNC** during steps 5 to 7.

To stop recording

Press **■** for the MD.

Tips

- The procedure described here explains how to record from CD 1 onto MD 1. To record from any other CD onto any other MD, see "Recording your favorite tracks" on page 37.
- If the MD is partially recorded, recording starts after the recorded tracks. To erase the recorded contents, see "Erasing recordings" on page 53.
- The CD/MD buttons for empty disc trays/slots do not flash.
- You can adjust the recording level to the desired volume after performing step 7 (see page 48).
- If you record on an unrecorded or completely erased (see page 54) MD, the disc title assigned to the CD (see page 31) is copied as it is to the MD (**Disc Memo Copy**). Depending on the disc, CD text information may also be copied. If "TEXT" flashes during recording, press **NAME EDIT/CHARACTER**, and then press **ENTER/YES** to record the title of the current track. (If "TEXT" is lit, it is automatically copied.)

Recording a CD on an MD (continued)

Ejecting an MD

Open the MD cover, and pull the MD out from the slot. If the MD has been loaded inside the unit (i.e., the corresponding MD 1 - 5 button is lit green), press MD ▲ so that the MD is returned to the slot, and then pull the MD out from the slot.

Before pulling out the power cord

MD recording is completed when the MD Table of Contents (TOC) is updated. The TOC is updated when you eject the MD or press I/⏻ (power) and turn off the system. Do not pull out the power cord before updating the TOC (while "TOC" is lit) or while updating the TOC (while "TOC" is flashing) to ensure the complete recording.

If the MD runs out of recording time

The CD player and the MD deck both stop automatically.

Note

If the MD is record-protected, "C11" and "Protected" appear alternately and the MD cannot be recorded.

Eject the MD, then slide close the tab at the side of the MD to cover the hole (see page 35).

Playing an MD

You can play up to 5 MDs in a row.

If the power is off, first press I/⏻ (power) to turn on the system.

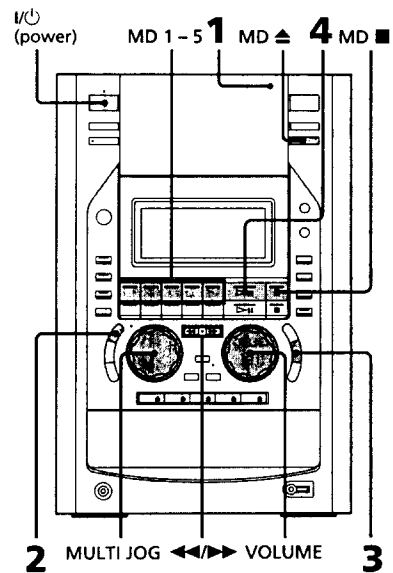

Playing an MD (continued)

To	Do this
Stop play	Press ■ for the MD.
Pause	Press ▷ for the MD (or MD on the remote). The light on the ▷ button changes from green to orange. Press again to resume play.
Select a track	Turn MULTI JOG clockwise (to go forward) or counter-clockwise (to go back) and release it when you locate the desired track (or press MD ►► or ◀◀ on the remote repeatedly).
Find a point in a track	Keep pressing ◀◀ or ►► during play and release it at the desired point.
Select an MD	<ul style="list-style-type: none"> • Press MD 1 - 5. Play starts when the button is pressed. • Press MD D.SKIP on the remote repeatedly so that the MD 1 - 5 button is lit green. Press ▷ for the MD (or MD ▷ on the remote) to play the selected MD. <p>If you press MD 1 - 5 (or MD D.SKIP on the remote) during play, the selected MD changes and the new MD starts playing.</p>
Remove an MD	Open the MD cover and pull the MD out from the slot. If the MD has been loaded inside the unit, (i.e., the corresponding MD 1 - 5 button is lit green), press MD ▲ so that the MD is returned to the slot, and then pull the MD out from the slot.
Adjust the volume	Turn VOLUME (or press VOL + or - on the remote).

Note

Do not use an MD on which the label sticks out from the edge or on which the label is not positioned correctly. Such labels can cause the MD deck to malfunction.

Tips

- You can switch from another source to the MD deck and start playing an MD just by pressing ▷|| for the MD (or MD ▷ on the remote) or MD 1 - 5 if an MD is loaded in the slot (**Automatic Source Selection**). However, if an MD is used in a program, play does not start even if you press MD 1 - 5.
- The MD 1 - 5 button indicators have the following meanings when lit,
 - Green: The MD loaded in the slot is selected or playing.
 - Orange: An MD is loaded in the slot.
- If an MD is not loaded to any of MD 1 - 5, "No Disc" appears.
- You can also select and start playing a track in step 4.
 - 1 Press MD D.SKIP on the remote and select the desired MD.
 - 2 Turn MULTI JOG (or press MD ◀◀ or ►► on the remote) until the desired track number appears.
 - 3 Press ▷|| for the MD (or MD ▷ on the remote).
- If you select or play a track on the MD recorded in monaural format, "MONO" indication lights white.

Listening to the radio

— Preset Tuning

Preset radio stations in the tuner's memory first (see page 10). You can also tune in the desired station manually (see "Listening to non-preset radio stations" on the next page). If the power is off, first press I/⏻ (power) to turn on the system.

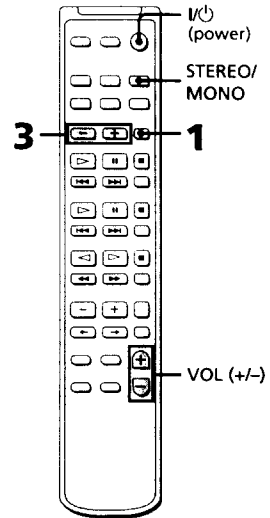
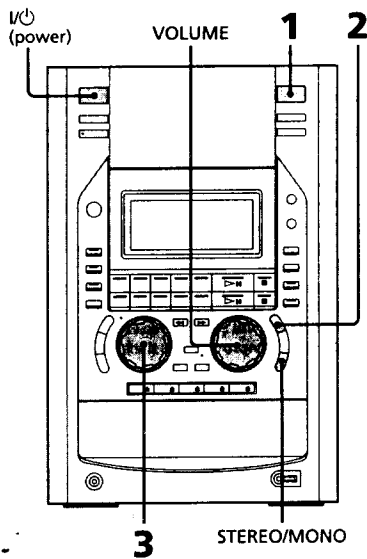

- 1 Press TUNER/BAND (or BAND on the remote) repeatedly until the band you want appears. Each time you press the button, the band changes as follows:

North American model:

→ FM → AM →

European model:

→ FM → MW → LW →

Other models:

→ FM → MW → SW →

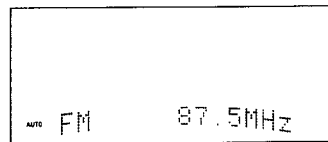

Listening to the radio (continued)

- 2** Press TUNING MODE repeatedly until "PRESET" appears.

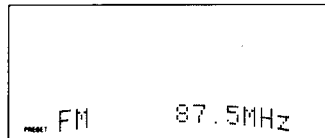

- 3** Turn MULTI JOG to tune in the desired preset station.
Or press PRESET (+/-) on the remote.

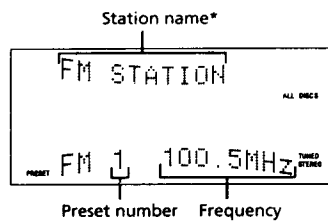

* The station name is displayed only when you have assigned a name to the preset station (see page 69).

To	Do this
Turn off the radio	Press I/⏻ (power).
Adjust the volume	Turn VOLUME (or press VOL \oplus or \ominus on the remote).

Listening to non-preset radio stations

- Press TUNING MODE repeatedly until "MANUAL" appears in step 2, then turn MULTI JOG to tune in the desired station. **(Manual Tuning)**
- Press TUNING MODE repeatedly until "AUTO" appears in step 2, then turn MULTI JOG slightly and release it. The frequency indication changes and scanning stops when the system tunes in a station. **(Automatic Tuning)**

To cancel Automatic Tuning

Press TUNING MODE.

Tips

- You can switch from another source to the tuner just by pressing TUNER/BAND (or BAND on the remote) **(Automatic Source Selection)**.
- To improve broadcast reception, reorient or move the supplied antennas near a window or outdoors. If broadcast reception does not improve, we recommend using a commercially available outdoor antenna (see page 81).
- When an FM stereo program is noisy, press STEREO/MONO repeatedly until "MONO" appears. There will be no stereo effect, but the reception will improve. Press the button again to restore the stereo effect.

Recording from the radio

— Manual Recording

You can analog record a radio program on an MD.

If the power is off, first press I/⏻ (power) to turn on the system.

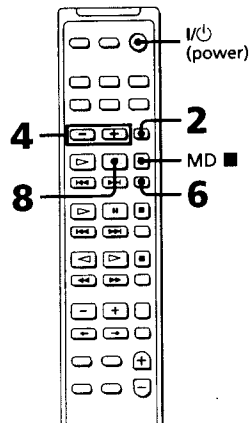
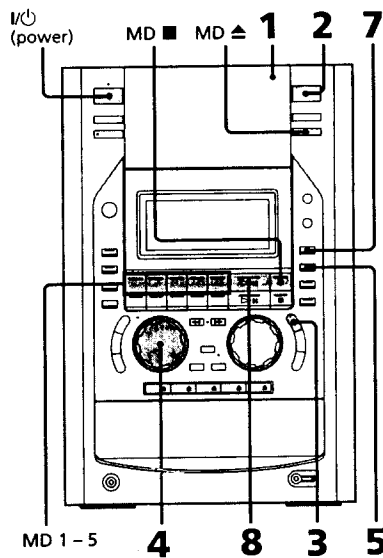

- 1 Insert a recordable MD to MD 1 - 5. Open the MD cover, slide the disc into the slot, and then close the cover.

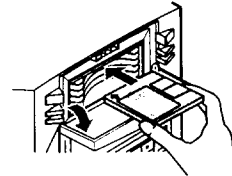

Inserting an MD

With the arrow pointing toward the deck

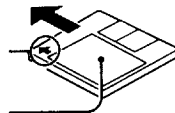

With the label side up

The front edge of the slot should be even with the edge of the MD.

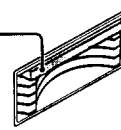

- 2 Press TUNER/BAND (or BAND on the remote) repeatedly until the band you want appears.

Recording from the radio (continued)

3 Press TUNING MODE repeatedly until "PRESET" appears.

4 Turn MULTI JOG to tune in the desired preset station.
Or press PRESET (+/-) on the remote.

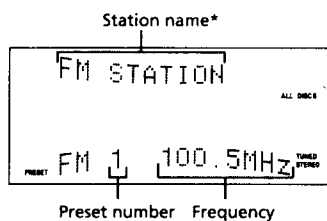

* The station name is displayed only when you have assigned a name to the preset station (see page 69).

5 Press REC MODE repeatedly until "1DISC" appears.

If you select "ALL DISCS", all loaded MDs are recorded in order from the MD in MD 1. Remove any unwanted MDs from the slots.

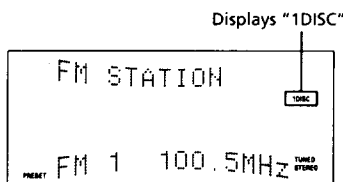

6 Press MD D.SKIP on the remote repeatedly so that the MD 1-5 button of the slot containing the recordable MD lights green.

7 Press REC.
The MD deck stands by for recording.

8 Press \triangleright II for the MD (or MD II on the remote).
Recording starts.

To stop recording

Press ■ for the MD.

Recording non-preset radio stations

- Press TUNING MODE repeatedly until "MANUAL" appears in step 3, then turn MULTI JOG to tune in the desired station. (Manual Tuning)
- Press TUNING MODE repeatedly until "AUTO" appears in step 3, then turn MULTI JOG slightly and release it. The frequency indication changes and scanning stops when the system tunes in a station. (Automatic Tuning)

To cancel Automatic Tuning

Press TUNING MODE.

Tips

- If the MD is partially recorded, recording starts after the recorded tracks. To erase recorded contents, see "Erasing recordings" on page 53.
- If you select "MONO" in step 5, the MD is recorded in monaural format. For details, see "Monaural recording" on page 49.
- You can adjust the recording level to the desired volume after performing step 7 (see page 48).
- If noise is heard while recording an AM (MW/LW or MW/SW) radio program, move the AM loop antenna to reduce the noise.

Ejecting an MD

Open the MD cover, and pull the MD out from the slot. If the MD has been loaded inside the unit (i.e., the corresponding MD 1 - 5 button is lit green), press MD ▲ so that the MD is returned to the slot, and then pull the MD out from the slot.

Before pulling out the power cord

MD recording is completed when the MD Table of Contents (TOC) is updated. The TOC is updated when you eject the MD or press I/⏻ (power) and turn off the system. Do not pull out the power cord before updating the TOC (while "TOC" is lit) or while updating the TOC (while "TOC" is flashing) to ensure the complete recording.

Note

If the MD is record-protected, "C11" and "Protected" appear alternately and the MD cannot be recorded.

Eject the MD and slide close the tab at the side of the MD to cover the hole (see page 35).

Listening to a CD/MD

Listening to tracks in a different order

— Shuffle Play, Program Play

Playing tracks in random order — Shuffle Play

You can play all the tracks on a disc or all discs in random order.

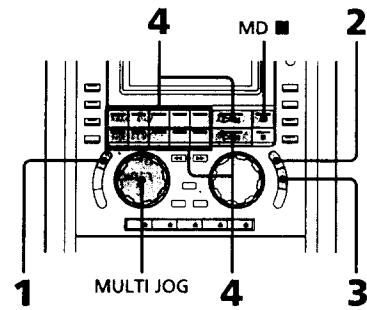

1 Press FUNCTION repeatedly to switch the function to CD or MD.

2 (If listening to an MD, press ■ to stop playing first.) Press PLAY MODE repeatedly until "SHUFFLE" appears.

CD:

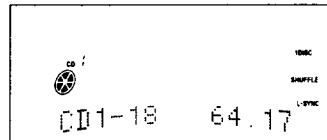

MD:

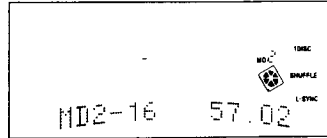



continued

Listening to tracks in a different order (continued)

- 3** Press 1/ALL repeatedly to select the desired CD or MD.

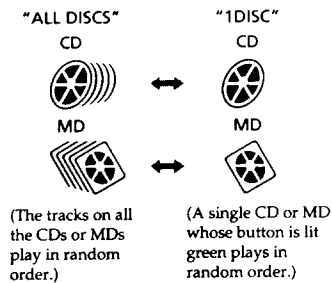
Each time you press the button, the display changes as follows:



- 4** If you selected "ALL DISCS", press  for the CD or MD. If you selected "1DISC", press CD/MD 1 - 5 for the tray or slot containing the desired CD or MD. Shuffle Play starts. While the system is selecting the next track, the disc number changes continuously if you selected "ALL DISCS", or the track number if you selected "1DISC".

To cancel Shuffle Play

(If listening to an MD, press  to stop playing first.) Press PLAY MODE so that "SHUFFLE" disappears.

Tips

- You can start Shuffle Play during normal CD play by pressing PLAY MODE. All tracks including those already played are played in random order.
- To skip a track, turn MULTI JOG clockwise (or press CD/MD  on the remote).

Notes

- You cannot use Program Play or Repeat Play for all tracks during Shuffle Play for "ALL DISCS".
- If you press PLAY MODE to change the play mode while playing an MD, "Push STOP!" appears. To change the play mode, press  first to stop play.

Programming the tracks — Program Play

You can make a program up to 25 tracks (steps) from all the CDs or MDs in the order you want them to be played.

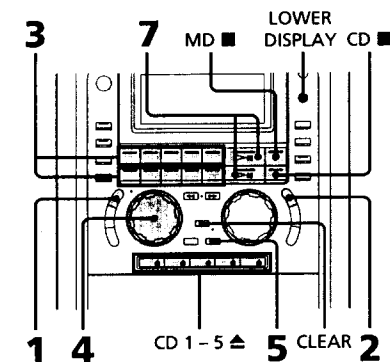

- 1** Press FUNCTION repeatedly to switch the function to CD or MD.

Notes

- You cannot make a program with both CD and MD tracks.
- You can program tracks only while the CD player or the MD deck is stopped.
- Wait for the total number of tracks and the playing time to appear, then proceed to the next step.

2 Press PLAY MODE repeatedly until "PROGRAM" appears.

3 Press CD/MD 1-5 (or CD/MD D.SKIP on the remote) to select the desired CD or MD.

CD:



CD tray number

MD:

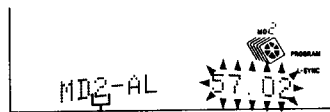

MD slot number

To program all of the tracks on a single CD or MD at once, proceed to step 5 with "AL" displayed.

4 Turn MULTI JOG until the desired track number appears.

Or press CD/MD ◀◀ or ▶▶ on the remote.

The playing time of the selected track flashes.

CD:

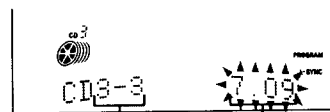

Selected CD and track numbers

Playing time of selected track

MD:

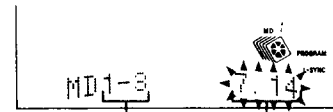

Selected MD and track numbers

Playing time of selected track

5 Press ENTER/YES.

The track is programmed. The number of the track in the programmed sequence (the Step number) appears, followed by the last programmed track number and the total playing time of all the programmed tracks.

If you made a mistake, you can clear the last programmed track from the program by pressing CLEAR.

CD:



Last track

Total playing time

MD:



Last track

Total playing time

6 To program additional tracks, repeat steps 3 to 5.

7 Press ▷|| for the CD or MD (or CD/MD ▷ on the remote).

All the tracks play in the order you selected.

Listening to tracks in a different order (continued)

To cancel Program Play

(If listening to an MD, press ■ to stop playing first.) Press PLAY MODE repeatedly until "PROGRAM" disappears.

To cancel the programming operation

Press ■ for the CD or MD during steps 3 to 5.

To clear the last programmed track

Press CLEAR in Program Play stop mode. Each time you press the button, a track is cleared from the end of the program.

To check the total number of the programmed tracks

Press LOWER DISPLAY in stop mode. The total number of the programmed tracks appears.

CD:

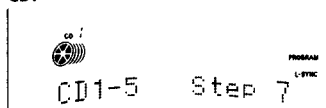

MD:

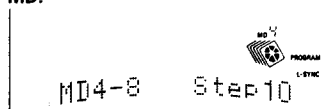

To check the program order

Turn MULTI JOG (or press CD/MD ►► on the remote) during Program Play. The tracks appear in the order programmed, and Program Play starts from the point where you release MULTI JOG.

To add a track to the program

1 Press CD/MD 1 - 5 (or CD/MD D.SKIP on the remote) in stop mode to select the desired CD or MD.

2 Turn MULTI JOG (or press CD/MD ◀◀ or ►► on the remote) to select the track number, then press ENTER/YES.

The selected track is added to the end of the program.

Tips

- The program you made remains after the Program Play has finished. To play the same program again, press ►► for the CD or MD (or CD/MD ◀ on the remote).
- To record tracks on an MD in the programmed order, see "Recording your favorite portions" on page 43.
- If you press any CD 1 - 5 ▲ and open a disc tray or remove an MD from the MD 1 - 5 slots, the tracks on the CD in that tray or the removed MD are erased from the program.
- If you program all of the tracks on a CD or MD at once (if you select "AL" in step 3), the disc is programmed as one track (step) in the program.
- "Step Full" appears when you try to program 26 or more tracks (steps).
- "----" appears when the total CD program time exceeds 100 minutes, or when you select a CD track whose number is 21 or over. In addition, "----" appears when the total MD program time exceeds 200 minutes.
- You can also make a CD program with a pause at any point from the second track onward. Press CD ■ on the remote before selecting CD in step 3. A pause is programmed as one track (step) in the program.

Note

If you insert a disc into a slot containing a disc used in a program you made (whose MD 1 - 5 button lights green), play stops and the entire program is cleared.

Playing tracks repeatedly

— Repeat Play

You can repeat a disc or all discs in normal play, "1DISC" Shuffle Play and Program Play.

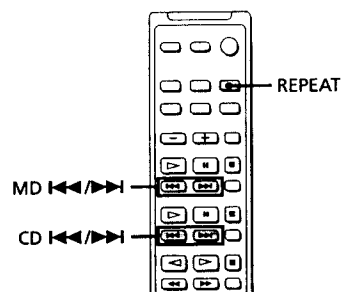

Playing all tracks or a program repeatedly

→ Press REPEAT during play until "REPEAT" appears.

You cannot perform Repeat Play for "ALL DISCS" during Shuffle Play.

Repeating a single track

→ Press REPEAT repeatedly while playing the track you want to repeat until "REPEAT 1" appears.

You can change the repeated track by pressing CD/MD \leftarrow or \rightarrow on the remote (or turning MULTI JOG on the system) during play.

To cancel Repeat Play

Press REPEAT repeatedly until "REPEAT" or "REPEAT 1" disappears.

Shortening the silence while changing the discs

— Quick Changer

You can shorten the silence while changing the discs when continuously playing multiple discs (ALL DISCS).

- 1 Press MENU/NO twice so that "Setup Menu" appears.
- 2 Turn MULTI JOG until "Q.Change Off" (or "Q.Change On") appears, then press ENTER/YES. "Q.Change Off" flashes.
- 3 Turn MULTI JOG until "Q.Change On" appears, then press ENTER/YES.
- 4 Press MENU/NO.
The system starts changing discs about 10 seconds before the last track finishes.

Notes

- You cannot use the Quick Changer function during Shuffle or Program Play.
- If you press \leftarrow , \rightarrow , \square , \blacktriangle , MENU/NO or MD 1 - 5 on the MD deck, D.SKIP on the remote, or turn MULTI JOG while changing the discs, "Q. Change Now!" appears and the buttons and MULTI JOG do not function.
- Even if you set the Quick Changer function to on, when you press MD 1 - 5 on the MD deck or D.SKIP on the remote, the Quick Changer function does not activate and the system operates normally.
- The Quick Changer function is factory set to off. If you turn the power off or pull out the AC power cord, the system will retain the last setting (Q.Change On or Off).

Using the display

You can check the time remaining in a single track, or on an entire CD or MD. You can also check the disc title or a track title of a CD or MD. Use the UPPER DISPLAY button (top) and the LOWER DISPLAY button (bottom) to switch the display.

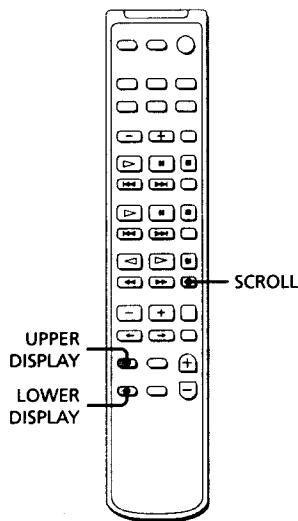

Use the UPPER DISPLAY button to switch the display.

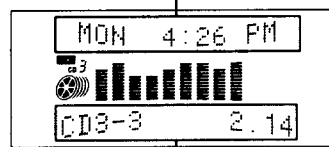

Use the LOWER DISPLAY button to switch the display.

Checking the remaining time

→ Press LOWER DISPLAY during play.

Each time you press the button, the display changes as follows:

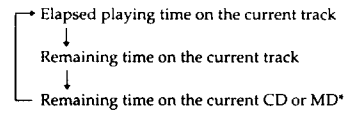

* The remaining time on the CD or MD is not displayed during Program or Shuffle Play.

Checking the total playing time and the remaining time

→ Press LOWER DISPLAY in stop mode.

Each time you press the button, the display changes as follows:

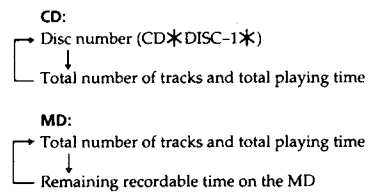

Checking a track title or a disc title

➔ Press UPPER DISPLAY during play or in stop mode.

Each time you press the button, the display changes as follows:

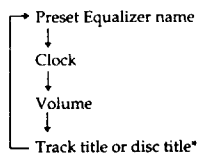

* The track title appears during play (only for an MD or a CD with CD text), and the disc title appears while stopped. If a CD or MD that has no title is loaded, nothing appears.

To scroll a long name

Press SCROLL on the remote. The title appears scrolling in the display.

Tips

- “--:--” appears when you check the remaining time of a CD track whose number is 21 or over.
- To label a disc title to a CD, see “Labeling a CD” on this page. To label a disc title or track titles to an MD, see “Labeling an MD” on page 51.
- If you press LOWER DISPLAY for a CD with CD text containing the artist name, the disc number appears scrolling in the display followed by the artist name.
- “MONO” indication lights white if you select or play a track on the MD recorded in monaural format.

Labeling a CD

— Disc Memo

You can create disc titles of up to 20 characters and symbols each for up to 100 CDs. These titles are stored in the system memory, and appear when the CD is loaded. When you record a CD on an unrecorded MD using Select Synchro Recording, the disc title on the CD is copied as the disc title on the MD (**Disc Memo Copy**).

Notes

- If you label a CD for which “TEXT” appears in the display, the disc title appears in place of the CD text title.
- When labeling CDs for the first time, be sure to perform the operations in “Erasing all disc titles stored in the system memory” on page 33 beforehand.

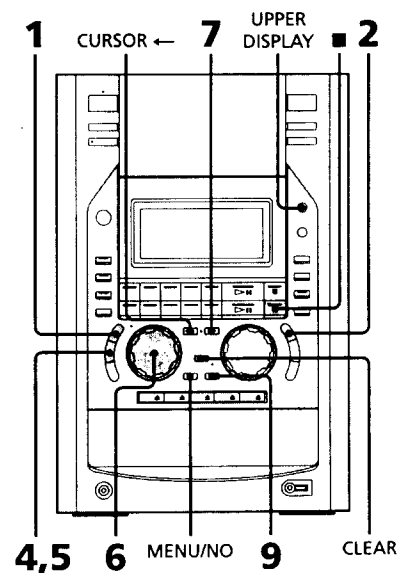

Listening to a CD/MD

Labeling a CD (continued)

- 1 Press FUNCTION repeatedly to switch the function to CD.

Note

You can input disc titles only when the CD player is in stop mode.

- 2 Press PLAY MODE repeatedly until "SHUFFLE" or "PROGRAM" disappears.

- 3 Press CD D.SKIP on the remote repeatedly until the number of the desired CD appears.

Wait for the total number of tracks and the total playing time to appear, then proceed to the next step.

- 4 Press NAME EDIT/CHARACTER. The text input screen appears, and the cursor flashes.

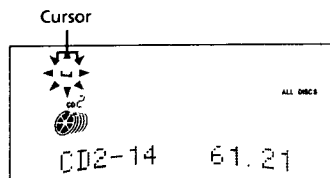

- 5 Press NAME EDIT/CHARACTER so that the desired type of character appears.

Each time you press the button, the display changes as follows:

- A (Upper cases) → a (Lower cases)
- 0 (Numbers) → ! (Symbols)
- □ (Blank space) → A → ...

- 6 Turn MULTI JOG until the character you want appears.

To enter a blank space

Press CURSOR → without turning MULTI JOG. You cannot enter a space as the first character.

To enter a symbol

You can use the following 24 symbols.
!"#\$%&'()*+,-./:;<=>?@_`

- 7 Press CURSOR → to enter the character.

The cursor shifts rightward and waits for the input of the next character.

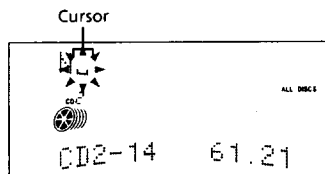

- 8 Repeat steps 5 to 7 to complete the entire title.

If you made a mistake

Press CURSOR ← or → until the character you want to change flashes, then repeat steps 5 to 7.

To erase the character

Press CLEAR. Each time you press the button, the character at the position of the cursor is erased. You cannot insert characters.

- 9 Press ENTER/YES to complete the labeling procedure.

The disc title is stored in the system memory.

To cancel labeling

Press ■ for the CD during steps 4 to 8.

Checking a disc title

- 1 Press MENU/NO in stop mode.
- 2 Turn MULTI JOG until "Name Check?" appears, then press ENTER/YES.
- 3 Turn MULTI JOG until the CD 1 – 5 disc or the stored disc (001 to 100) you want to check appears.
The disc title appears scrolling in the display.

To check the disc titles with the remote

Press CD D.SKIP until the desired CD appears, then press SCROLL.

Tip

You can also check the disc titles by pressing UPPER DISPLAY in stop mode (see page 31).

Erasing a disc title

- 1 Press MENU/NO in stop mode.
- 2 Turn MULTI JOG until "Name Erase ?" appears, then press ENTER/YES.
- 3 Turn MULTI JOG until the CD 1 – 5 disc or the stored disc (001 to 100) you want to erase appears.
The disc title appears scrolling in the display.
- 4 To erase the disc title, press ENTER/YES.
The disc title is erased and "Complete!!" appears.

To cancel erasing

Press ■ for the CD during steps 1 to 3.

Erasing all disc titles stored in the system memory

- 1 Press MENU/NO in stop mode.
- 2 Turn MULTI JOG until "All Erase ?" appears, then press ENTER/YES.
"All Erase ??" appears.
- 3 To erase all the disc titles, press ENTER/YES.
All the disc titles are erased and "Complete!!" appears.

To cancel erasing

Press ■ for the CD during steps 1 or 2.

Note

Turn on the system power at least once a week to ensure the stored disc titles are not erased.

Checking CD text information

You can display the CD text (CD title, artist name, track titles and other information) when this information is recorded on the CD.

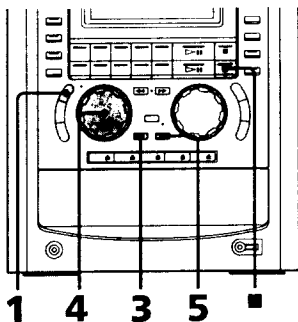

Checking a disc title

- 1 Press **FUNCTION** repeatedly to switch the function to CD.
- 2 Press **CD D.SKIP** on the remote repeatedly until the number of the desired CD appears.
- 3 Press **MENU/NO.**
- 4 Turn **MULTI JOG** until "Name Check?" appears.

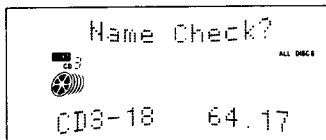

- 5 Press **ENTER/YES**.
Up to 20 characters of the disc title appear scrolling in the display.

Checking a track title

- Turn **MULTI JOG** during play or in stop mode until the desired track appears.
The track title appears scrolling in the display.

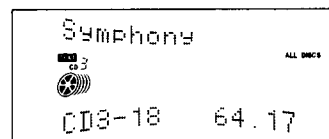

To cancel checking

Press **■** for the CD.

Viewing the CD text title during play

- 1 Press **MENU/NO.**
- 2 Turn **MULTI JOG** until "Name Check?" appears.
- 3 Press **ENTER/YES**.
Up to 20 characters of the CD title appear scrolling in the display.

Tip

CD text information is copied to MDs in some cases.

Recording on an MD

Before you start recording

MDs (MiniDisc) let you digitally record and play back music with high quality sound. Another feature of MDs is track marking like that on CDs. The track marking feature lets you quickly locate a specific point or easily edit the recorded tracks. Also, the way the signals and track numbers are recorded differs depending on the source.

When the source you want to record from is:

- **This system's CD player**
 - The digital signal from the CD is recorded as it is (digital recording)*.
 - Track numbers are automatically marked as on the original CD.
- **This system's tuner or other optional components connected to the TAPE or DVD/VIDEO input jacks, etc. (e.g., a tape deck, DVD player or VCR)**
 - The analog signal is converted to a digital signal and recorded (analog recording).
 - A track number is marked at the beginning of a recording, but when you turn on the Level Synchro Recording function (see page 46), track numbers are automatically marked in sync with the level of the input signal.

* For details on limitations of digital recording, see page 83.

Note on the track numbers of an MD

On an MD, the track numbers (track sequence), track start and end point information, etc., are recorded in the TOC** area independent of the sound information. You can edit recorded tracks quickly by modifying the TOC information.

** TOC: Table Of Contents

After recording

- ➔ Eject the MD, or press I/⏻ (power) and turn off the system.

The TOC is updated and recording is completed.

Before pulling out the power cord

MD recording is completed when the MD Table of Contents (TOC) is updated. The TOC is updated when you eject the MD or press I/⏻ (power) and turn off the system. Do not pull out the power cord before updating the TOC (while "TOC" is lit) or while updating the TOC (while "TOC" is flashing) to ensure the complete recording.

Protecting a recorded MD

- To record-protect an MD, slide open the tab at the side of the MD.

In this position, the MD cannot be recorded. To record on the MD, slide close the tab to cover the hole.

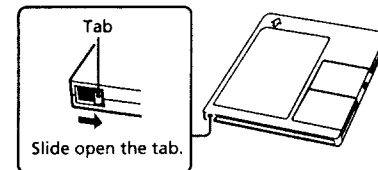

- If the MD is record-protected, "C11" and "Protected" appear alternately and the MD cannot be recorded.

To record on the MD, first eject the MD, then slide close the tab at the side of the MD to cover the hole.

Types of recording

You can choose from the following 11 types of recording in accordance with the purpose.

CD Synchro Recording

Tracks are recorded to the MD in the same sequence as the original CD.

- Recording a CD on an MD (**Select Synchro Recording**) — page 16



CD 1 is recorded to MD 1.

- Recording 1 to 5 CDs in succession on an MD (**Seamless Recording**) — page 39

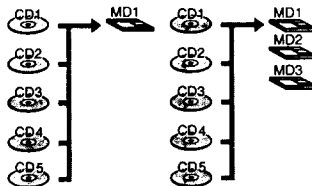

If all the tracks cannot fit on a single MD, recording switches automatically to the next MD. Tracks are not cut off and the space between tracks is not lengthened.

Recording specific tracks

- Selecting the tracks that you want to record on MD 1 – 5 from CD 1 – 5, and recording them in the order in which they were selected (**Select Synchro Recording**) — next page

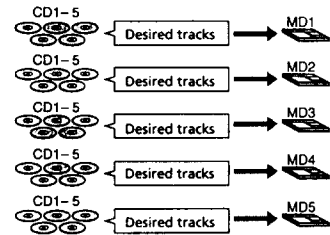

Up to 25 tracks can be selected for one MD.

- Recording only the first track on each CD (**Hit Parade**) — page 41

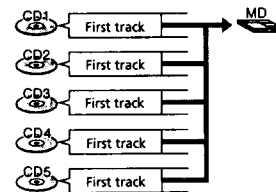

- Quickly recording the current CD track (**Rec It**) — page 42

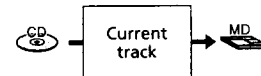

- Recording your favorite portions (**Manual Recording**) — page 43
You can use the CD Program Play function to select tracks for recording.

Other types of recording

- Making the space between tracks 3 seconds long (**Smart Space/Auto Cut**) — page 44
You can make the blank space between tracks 3 seconds long when recording CDs or digitally recording a satellite broadcast on an MD.
- Starting recording with 6 seconds of prestored audio data (**Time Machine Recording**) — page 45
This feature keeps you from losing the first few seconds of material when recording an FM or satellite broadcast on an MD.
- Marking track numbers automatically while recording (**Level Synchro Recording**) — page 46
You can mark track numbers automatically in sync with the level of the input signal from the sound source (except when digitally recording a CD or MD).
- Marking track numbers at a specific point while recording — page 47
You can mark track numbers at any time during both analog and digital recording.
- Monaural recording — page 49
You can record FM broadcasts and other stereo sources in monaural format. This doubles the recording time (e.g., 120 minutes on a 60-minute MD).

You can also move tracks, erase tracks and edit the recorded contents (see pages 50 – 61).

▶ Recording a CD

Recording your favorite tracks

— Select Synchro Recording

You can record from a CD to an MD with the same number (e.g., from CD 1 to MD 1, from CD 2 to MD 2, etc.).

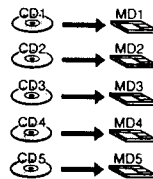

You can also select up to 25 tracks from up to 5 CDs to record on up to 5 MDs at one time.

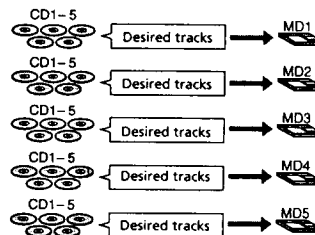

If the MD is partially recorded, recording starts after the recorded tracks.

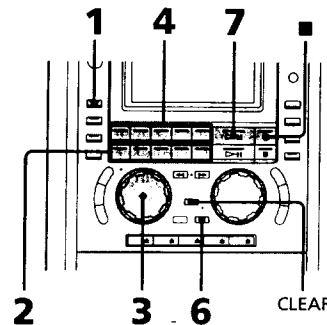

**Recording your favorite tracks
(continued)**

1 Press SELECT SYNC.
"SELECT" appears, and the CD 1-5 buttons flash.

2 Press CD 1-5 to select the desired CD.

The selected CD 1-5 button lights green. To record an entire CD in the same sequence as the original, proceed to step 4 while "AL" is displayed.

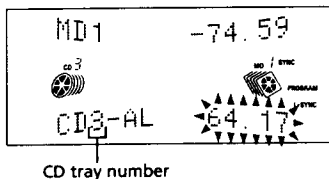

CD tray number

3 Turn MULTI JOG to select the desired track.

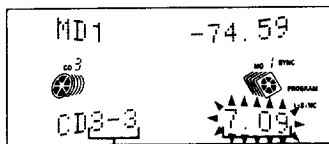

Selected CD and track number Track playing time

4 Press MD 1-5 to select the destination MD.
The selected MD 1-5 button lights green. The display shows the remaining time and the total playing time on the selected MD.

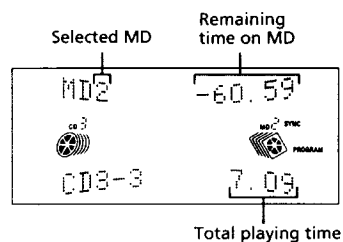

Total playing time

If "Step Full" appears

More than 25 tracks have been programmed for the selected MD.

5 To select other tracks, repeat steps 2 to 4.

6 Press ENTER/YES.
"SYNC" flashes for a while, and then remains lit. The MD deck stands by for recording, and the CD player is in pause for playing.

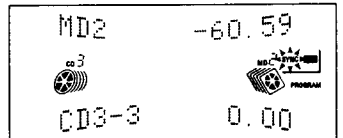

7 Confirm that "SYNC" is now lit, and then press >|| for the MD.
Recording starts in order from MD 1. Once recording on all of the selected MDs has been completed, the CD player and the MD deck both stop automatically.

To cancel recording

Press SELECT SYNC.

To stop recording

Press ■ for the MD.

To confirm/clear the selected contents

Press MD 1 – 5 after step 4. Each time the button is pressed, the programmed CD disc numbers and track numbers for the selected MD appear in order. To clear the displayed contents, press CLEAR. The displayed contents are cleared. To program additional tracks, continue from step 2.

Tips

- When you record from CD 1 – 5 to MD 1 – 5, select a CD and MD with the same numbers in steps 2 and 4 of “Recording your favorite tracks”. (Step 3 is not needed.) If you record on an unrecorded or completely erased (see page 54) MD, the disc title assigned to the CD (see page 31) is copied as it is to the MD (**Disc Memo Copy**). Depending on the disc, CD text information may also be copied. If “TEXT” flashes during recording, press NAME EDIT/CHARACTER, and then ENTER/YES to record the title of the current track. (If “TEXT” is lit, it is automatically copied.)

You can also freely select the CD and MD numbers for recording, for example, from CD 1 and CD 2 to MD 1, and from CD 3 and CD 4 to MD 2.

- While recording, the light of the CD 1 – 5 buttons and the MD 1 – 5 buttons indicates the following:
Green: CD/MD that is currently recording
Orange: CD/MD that is currently standing by for recording
Off: Unselected CD/MD
- If the MD is record-protected, “C11” and “Protected” appear alternately and the MD cannot be recorded (see page 35).
- If the MD ends during recording, the CD and MD stop (even if recording was still in progress), and recording begins on the next MD.

Before pulling out the power cord

MD recording is completed when the MD Table of Contents (TOC) is updated. The TOC is updated when you eject the MD or press I/⏻ (power) and turn off the system. Do not pull out the power cord before updating the TOC (while “TOC” is lit) or while updating the TOC (while “TOC” is flashing) to ensure the complete recording.

Recording multiple CDs in succession on multiple MDs

— Seamless Recording

You can record all of the loaded CDs onto all of the loaded MDs in sequence. For example, you can record 5 single CDs in succession on an MD.

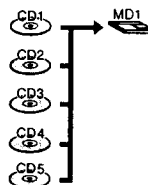

You can also record a 5-disc album on 3 MDs.

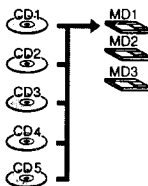

Recording multiple CDs in succession on multiple MDs (continued)

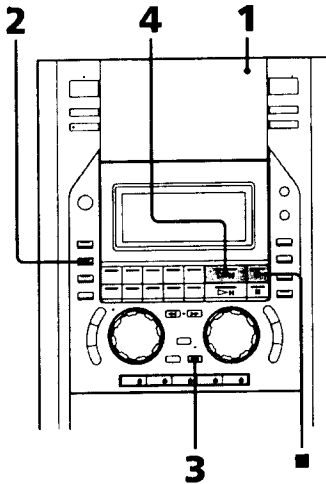

- 1** Insert the recordable MDs in order from the MD 1 slot. Recording starts in order from the MD in the MD 1 slot. Remove any unwanted MDs from the slots. If the MDs have been partially recorded, recording starts after the recorded tracks.

- 2** Press SEAMLESS.

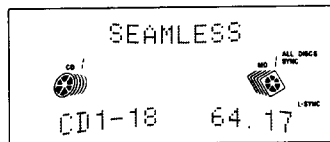

- 3** Press ENTER/YES. "SYNC" flashes for a while, and then remains lit. The MD deck stands by for recording, and the CD player is in pause for playing.

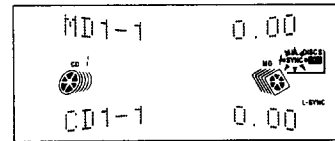

- 4** Confirm that "SYNC" is now lit, and then press >|| for the MD. CD playing and MD recording start. If all the tracks cannot fit on a single MD, recording switches automatically to the next MD. The CD player and MD deck stop automatically when the recording of all the loaded CDs is completed.

To cancel recording

Press SEAMLESS.

To stop recording

Press ■ for the MD.

Before pulling out the power cord

MD recording is completed when the MD Table of Contents (TOC) is updated. The TOC is updated when you eject the MD or press I/O (power) and turn off the system. Do not pull out the power cord before updating the TOC (while "TOC" is lit) or while updating the TOC (while "TOC" is flashing) to ensure the complete recording.

Note

If all the tracks cannot fit on a single MD, recording switches automatically to the next MD. Be sure to insert the recordable MDs beforehand and remove any unwanted MDs from the slots.

Recording only the first track

— Hit Parade

You can record the first track of each CD. This feature is useful when you record single CDs in succession.

If the MD has been partially recorded, recording starts after the recorded tracks.

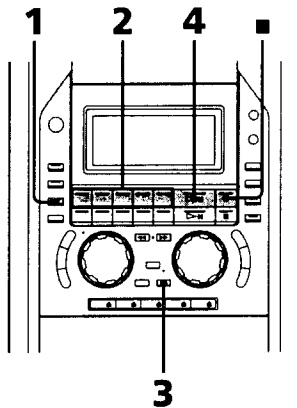

- 1 Press HIT PARADE.

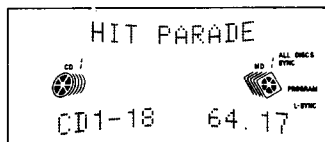

- 2 Press one of MD 1 – 5 to select the desired MD.

- 3 Press ENTER/YES.

"SYNC" flashes for a while, and then remains lit. The MD deck stands by for recording, and the CD player is in pause for playing.

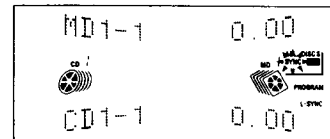

- 4 Confirm that "SYNC" is now lit, and then press >|| for the MD. Recording starts. The CD player and MD deck stop automatically when the recording is completed.

To record from 6 or more CDs

Repeat steps 1 to 4 after changing the CDs.

To cancel recording

Press HIT PARADE.

To stop recording

Press ■ for the MD.

Before pulling out the power cord

MD recording is completed when the MD Table of Contents (TOC) is updated. The TOC is updated when you eject the MD or press I/⏻ (power) and turn off the system. Do not pull out the power cord before updating the TOC (while "TOC" is lit) or while updating the TOC (while "TOC" is flashing) to ensure the complete recording.

Recording the current track

— Rec It

You can record a track quickly while listening to a CD.

If the MD has been partially recorded, recording starts after the recorded tracks.

To stop recording

Press ■ for the MD.

Before pulling out the power cord

MD recording is completed when the MD Table of Contents (TOC) is updated. The TOC is updated when you eject the MD or press I/⏻ (power) and turn off the system. Do not pull out the power cord before updating the TOC (while "TOC" is lit) or while updating the TOC (while "TOC" is flashing) to ensure the complete recording.

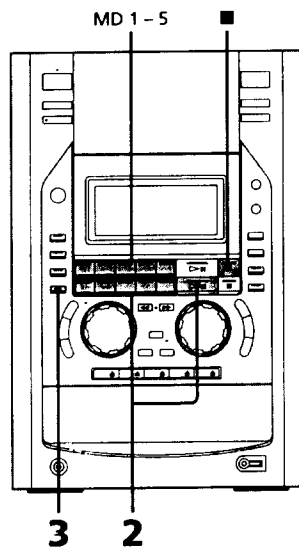

- 1** Press MD D.SKIP on the remote repeatedly so the button of the desired MD lights green.
- 2** Press ▷|| for the CD or CD 1-5. CD play starts.
- 3** Press REC IT while listening to a track you want to record. Play returns to the start of the track and recording starts. The MD deck stops automatically at the end of the track.

Recording your favorite portions

— Manual Recording

Use this method to record only certain portions of a CD, or to record tracks in the programmed order.

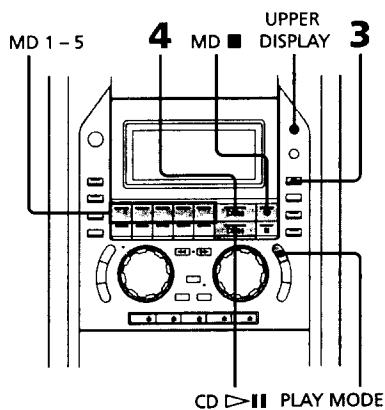

- 1** Insert a recordable MD, then press MD D.SKIP on the remote repeatedly so the button of the desired MD lights green.

You can record on any of the MDs in MD 1 - 5. If the MD has been partially recorded, recording starts after the recorded tracks.
- 2** Load a CD (CDs), and set the CD to playing or playing pause.

To record tracks in the order you programmed, press PLAY MODE repeatedly until "PROGRAM" appears.
- 3** Press REC.

The MD deck stands by for recording.

- 4** Press >|| for the MD.

Recording starts.

If the CD is in playing pause, press >|| for the CD to start playing the CD.

To stop recording

Press ■ for the MD.

Tip

Each time you press UPPER DISPLAY during recording, the recording time and remaining time of the MD appear alternately in the display.

Note

If recording is paused, a track number is assigned at the position where recording was paused. In addition, if tracks with the same track numbers from the same CD or the same track numbers from different CDs are recorded consecutively, only one track number might be assigned.

Before pulling out the power cord

MD recording is completed when the MD Table of Contents (TOC) is updated. The TOC is updated when you eject the MD or press I/⏻ (power) and turn off the system. Do not pull out the power cord before updating the TOC (while "TOC" is lit) or while updating the TOC (while "TOC" is flashing) to ensure the complete recording.

Making the space between tracks 3 seconds long

— Smart Space, Auto Cut

If there is an extended silence during recording, this silence can be replaced with a blank of about 3 seconds.

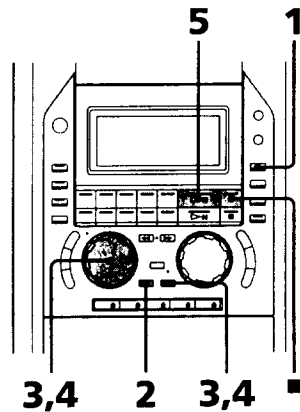

- 1 Press REC, and set the MD deck to recording standby.
- 2 Press MENU/NO twice so that "Setup Menu" appears.
- 3 Turn MULTI JOG until "S.Space Off" (or "S.Space On") appears, then press ENTER/YES.

- 4 Turn MULTI JOG until "S.Space On" appears, then press ENTER/YES.

- 5 Press ▷|| for the MD. Recording starts.

If there is an extended silence of less than 30 seconds, "Smart Space" appears, and the MD deck replaces the silence with a blank of about 3 seconds and continues recording.

If there is no sound input for 30 seconds or more, "Auto Cut" appears, and the MD deck replaces the silence with a blank of about 3 seconds and switches to recording pause. Press ▷|| for the MD to restart the recording.

To stop recording

Press ■ for the MD.

To turn off the Smart Space and Auto Cut functions

- 1 Press MENU/NO twice during recording pause, so that "Setup Menu" appears.
- 2 Turn MULTI JOG until "S.Space On" appears, then press ENTER/YES.
- 3 Turn MULTI JOG until "S.Space Off" appears, then press ENTER/YES.

Tip

The Smart Space and Auto Cut functions are factory set to on. If you turn off the system or disconnect the AC power cord, the MD deck will retain the last setting (S.Space On or Off).

► Recording from the Radio

Starting recording with 6 seconds of prestored audio data

— Time Machine Recording

When recording from an FM or satellite broadcast, the first few seconds of material are often lost due to the time it takes you to ascertain the contents and press the record button. To prevent the loss of this material, the Time Machine Recording feature constantly stores the most recent audio data in a buffer memory. This lets you record the sound from 6 seconds (12 seconds for monaural recording) before starting recording, as shown in the illustration below:

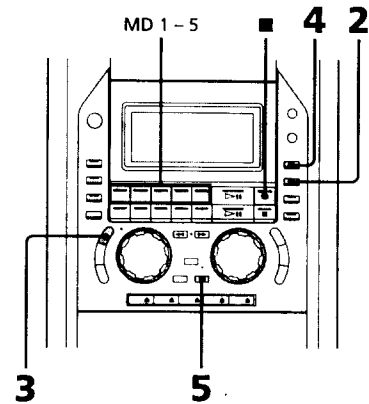
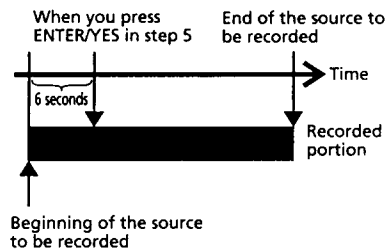

Recording on an MD — Recording from the Radio

- 1** Insert a recordable MD, then press MD D.SKIP on the remote repeatedly so the button of the desired MD lights green. You can record on any of the MDs in MD 1 – 5. If the MD has been partially recorded, recording starts after the recorded tracks.
- 2** Press REC MODE repeatedly until “1DISC” appears. To make a monaural recording, select “MONO”. For details, see “Monaural recording” on page 49.
- 3** Press FUNCTION repeatedly until “TUNER” appears.
- 4** Press REC. The MD deck stands by for recording.
- 5** Press ENTER/YES at the point you want to start recording. Recording of the source starts with the 6 seconds of audio data stored in the buffer memory.

continued

Starting recording with 6 seconds of prestored audio data (continued)

To stop Time Machine Recording

Press ■ for the MD.

Tip

You can adjust the recording level to the desired volume after performing step 4 (see page 48).

Before pulling out the power cord

MD recording is completed when the MD Table of Contents (TOC) is updated. The TOC is updated when you eject the MD or press I/⏻ (power) and turn off the system. Do not pull out the power cord before updating the TOC (while "TOC" is lit) or while updating the TOC (while "TOC" is flashing) to ensure the complete recording.

Note

The MD deck starts storing audio data when the deck stands by for recording (step 4). If less than 6 seconds have passed since the deck was set to recording standby, Time Machine Recording starts with less than 6 seconds of audio data.

Marking track numbers

You can mark track numbers:

- **Automatically while recording**
Track numbers are automatically marked as on the original source during CD and MD digital recording.
Use the Level Synchro Recording feature to automatically mark track numbers while recording other sources.
- **At any point while recording**
You can mark track numbers at any time while recording, regardless of the type of sound source.
- **After recording**
Use the Divide Function (see page 58).

Marking track numbers automatically while recording

— Level Synchro Recording

The Level Synchro Recording feature is factory set to on, so track numbers are automatically marked. If "L-SYNC" does not appear in the display during recording, follow the procedure below and turn on Level Synchro Recording. Track numbers are automatically marked when the input signal is continuously below a certain level for about 2 seconds or more and then exceeds that level again.

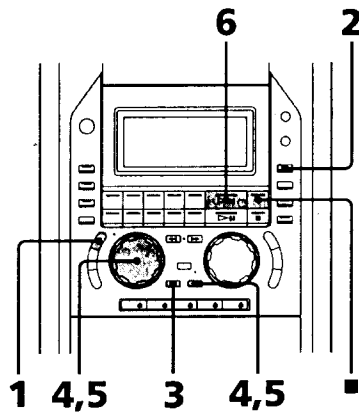

- 1** Press FUNCTION repeatedly until "TUNER" appears.
To record from an optional component connected to this system, select "TAPE" or "DVD (VIDEO)".
- 2** Press REC to set the MD deck to recording standby.
- 3** Press MENU/NO twice, so that "Setup Menu" appears.
- 4** Turn MULTI JOG until "T.Mark Off" appears, then press ENTER/YES.
- 5** Turn MULTI JOG until "T.Mark LSync" appears, then press ENTER/YES.
"L-SYNC" appears.
- 6** Press ▷|| for the MD.
Recording starts.

To stop recording

Press ■ for the MD.

To cancel the track marking

- 1** Press MENU/NO twice during recording pause, so that "Setup Menu" appears.
- 2** Turn MULTI JOG until "T.Mark LSync" appears, then press ENTER/YES.
- 3** Turn MULTI JOG until "T.Mark Off" appears, then press ENTER/YES.
"L-SYNC" disappears.

When "L-SYNC" is off, a track number is marked only at the start of recording.

Note

You cannot mark track numbers automatically if the sound source to be recorded is noisy (e.g., tapes or radio programs), even if the Level Synchro Recording feature is on.

Marking track numbers at a specific point while recording

You can mark track numbers at any time while recording, regardless of the type of sound source.

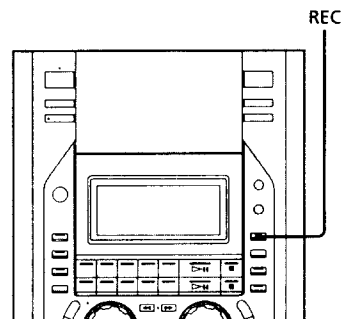

- ➔ Press REC while recording at the point you want to add a track mark.
A track number is marked at that point.

Adjusting the recording level

When recording on an MD, you can adjust the recording level to the desired volume. You can adjust the recording level not only when making an analog recording, but also when making a digital recording from a CD, etc.

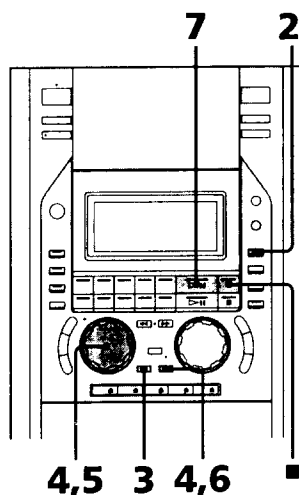

- 1 Prepare the sound source you want to record and start play.
- 2 Confirm that the MD deck is in recording standby. If not, press REC.
- 3 Press MENU/NO twice so that "Setup Menu" appears.
- 4 Turn MULTI JOG until "Level Adjust?" appears, then press ENTER/YES.

- 5 Turn MULTI JOG to adjust the recording level. While monitoring the sound, adjust to the optimum level while making sure that "OVER" does not appear in the display at the loudest portion. Once you have adjusted the recording level, stop playing.

Adjust the level so that "OVER" does not appear

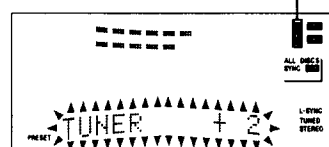

- 6 Press ENTER/YES.
- 7 Press for the MD. Recording starts. When recording a CD, etc., start playing.

To stop recording

Press for the MD.

Tips

- You can also adjust the recording level during recording. Do steps 3 to 6 while recording, and press MENU/NO.
- Once adjusted, the recording level is maintained until you adjust it again.

Monaural recording

Stereo signals such as an FM stereo broadcast can be converted to monaural format and recorded. When recording in monaural format, the MD recording time is approximately twice the normal recording (stereo recording) time (i.e., 120 minutes of monaural audio can be recorded on a 60-minute MD).

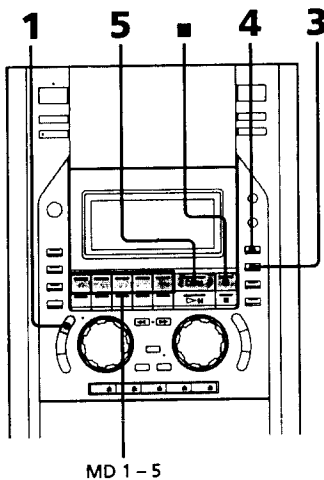

- 1 Press FUNCTION repeatedly until "TUNER" appears.
- 2 Press MD D.SKIP on the remote repeatedly so the button of the desired MD lights green.

- 3 Press REC MODE repeatedly until "1DISC" and "MONO" appear.

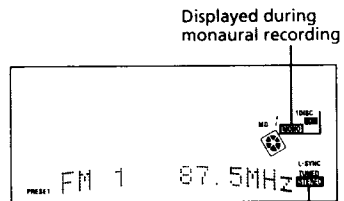

- 4 Press REC. The MD deck stands by for recording.
- 5 Press >|| for the MD. Recording starts. The sound source is heard as is (e.g., stereo sound when recording a stereo broadcast) from the speakers.

To stop recording

Press ■ for the MD.

Editing an MD

Before you start editing

You can edit the recorded tracks on an MD by moving and erasing tracks, etc. By editing the recorded tracks, you can create original MD albums without dubbing between MDs.

Editing functions

- **Name — Labeling MDs and tracks**
You can create titles for your recorded MDs and tracks using alphabet letters (upper and lower cases), numbers and some symbols.
- **Erase — Erasing recordings**
You can erase unwanted tracks.
- **Move — Moving recorded tracks**
You can freely change the order of the recorded tracks.
- **Divide — Adding track numbers**
When you divide a track, a track number is added at the start of the new track. You can also mark track numbers in the middle of a track, letting you easily find your favorite phrases.
- **Combine — Combining recorded tracks**
This function erases the blank space between two tracks and joins them into a single track.
This function also lets you join separated tracks such as tracks 1 and 4.
- **Undo — Undoing the last edit**
If you erase the wrong track or change the track order incorrectly, this function lets you cancel the last edit and restore the tracks and track order to the condition before the edit.

Before you start editing

You can edit an MD only when:

- The MD is not record-protected.
- The MD play mode is normal play.

Be sure to check the following before starting editing:

- 1** Check that the MD is not record-protected.
Slide close the tab at the side of the MD to cover the hole.
If the MD is record-protected, you cannot edit the MD.
- 2** Press PLAY MODE so "SHUFFLE" or "PROGRAM" disappears to select normal play.
You can edit MDs only during normal play. You cannot edit MDs during Shuffle or Program Play.

After editing

- ➔ Eject the MD, or press I/⏻ (power) to turn off the system.
"TOC writing" flashes. The MD Table of Contents (TOC) is updated and editing is completed.

Before pulling out the power cord

MD editing is completed when the MD Table of Contents (TOC) is updated. The TOC is updated when you eject the MD or press I/⏻ (power) and turn off the system. Do not pull out the power cord before updating the TOC (while "TOC" is lit) or while updating the TOC (while "TOC" is flashing) to ensure the complete editing.

Labeling an MD

— Name Function

During Select Synchro Recording, if a CD has a disc title (name), the same title is assigned to the MD (Disc Memo Copy). However, you can also create titles for your recorded MDs and tracks during play or in stop mode. A total of approximately 1700 characters can be input for the disc title and track titles on a single MD.

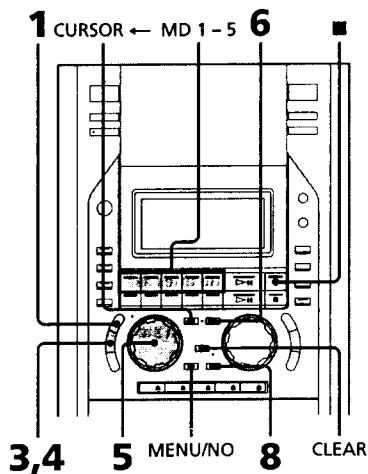

1 Press FUNCTION repeatedly to switch the function to MD.

2 Select the desired MD.
To label a disc title, press MD D.SKIP on the remote repeatedly so the button of the desired MD lights green. If the MD appears in the slot, press to load the MD (to the recording/playing unit). To label a track title, turn MULTI JOG until the track number you want to label appears.

3 Press NAME EDIT/CHARACTER. The text input screen appears, and the cursor flashes.

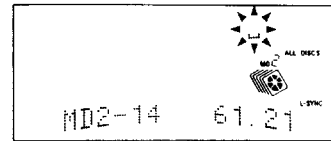

4 Press NAME EDIT/CHARACTER to select the desired type of character.

Each time you press the button, the display changes as follows:

A (Upper cases) → a (Lower cases)
→ 0 (Numbers) → ! (Symbols)
→ (Blank space) → A → ...

5 Turn MULTI JOG until the character you want appears.

To enter a blank space

Press CURSOR → without turning MULTI JOG. You cannot enter a space as the first character.

To enter a symbol

You can use the following 24 symbols.

! " # \$ % & ' () * + , - . / : ; < = > ? @ _

6 Press CURSOR → to enter the character. The cursor shifts rightward and waits for the input of the next character.

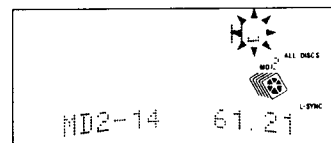

Labeling an MD (continued)

- 7** Repeat steps 4 to 6 to complete the entire title.

If you made a mistake

Press CURSOR ← or → until the character you want to change flashes, then repeat steps 4 to 6.

To erase the character

Press CLEAR. Each time you press the button, the character at the position of the cursor is erased. You cannot insert characters.

- 8** Press ENTER/YES to complete the labeling procedure. The titles you entered appear sequentially, then the display returns to the display in step 1.

To cancel labeling

Press ■ for the MD.

Copying a disc or track title

You can copy a labeled disc or track title to use it as a title of another track or the disc title within a disc.

- 1 Press MENU/NO so "Edit Menu" appears.
- 2 Turn MULTI JOG until "Name ?" appears, then press ENTER/YES.
- 3 Turn MULTI JOG until "Nm Copy ?" appears, then press ENTER/YES.

- 4** Turn MULTI JOG to select "Disc" (when copying the disc title) or the track number with the title you want to copy, then press ENTER/YES.

When "No Name" appears

The disc or track has not been labeled.

- 5** Turn MULTI JOG to select the copy destination track number or "Disc" (when copying as the disc title), then press ENTER/YES.

When "Overwrite ?" appears

The copy destination already has a disc or track title. To continue and copy the title, press ENTER/YES.

To cancel copying

Press ■ for the MD.

Checking the titles

To check the disc title, press SCROLL on the remote while the deck is stopped. To check the track title, press SCROLL on the remote while in play. The title appears scrolling in the display. To stop scrolling, press SCROLL. Press the button again to restart scrolling. You can also check the titles as follows.

- To check a disc title, press MD D.SKIP on the remote repeatedly in stop mode until the desired MD appears.
- To check a track title, turn MULTI JOG in stop mode until the desired track number appears.

Notes

- You can also display disc and track titles by pressing UPPER DISPLAY, but only the first 14 characters appear. The remaining characters do not scroll in the display.
- You can label a track title while recording, but you must complete the labeling before the track ends.

Erasing the titles

To erase the disc title and all track titles at once

- 1 Press MENU/NO so that "Edit Menu" appears.
- 2 Turn MULTI JOG until "Name ?" appears, then press ENTER/YES.
- 3 Turn MULTI JOG until "Nm All Ers ?" appears, then press ENTER/YES. "Nm All Ers ?" appears.
- 4 To erase all the titles, press ENTER/YES. "Complete!!" appears, and the disc title and all track titles are erased.

To erase a disc title or a track title

- 1 Press MENU/NO so that "Edit Menu" appears.
- 2 Turn MULTI JOG until "Name ?" appears, then press ENTER/YES.
- 3 Turn MULTI JOG until "Nm Erase ?" appears, then press ENTER/YES.
- 4 Turn MULTI JOG until the disc title or the track number with the title you want to erase appears, then press ENTER/YES. "Complete!!" appears, and the disc title or the track title is erased.

To cancel erasing

Press MENU/NO.

To return to the condition before labeling/erasing

You can return to the original condition immediately after labeling or erasing a title (see page 61).

Erasing recordings

— Erase, A-B Erase Function

The MD deck lets you erase unwanted sound quickly and easily. You can restore erased recordings by using the Undo Function (see page 61) immediately after the erase operation. However, you cannot restore erased recordings if you do other editing, so be careful when erasing recordings. The three options to erase recordings are:

- Erasing a single track (Tr Erase Function)
- Erasing all tracks (All Erase Function)
- Erasing a portion of a track (A-B Erase Function)

Erasing a single track (Tr Erase Function)

You can erase a track simply by specifying its track number. When you erase a track, the total number of tracks on the MD decreases by one and all the tracks following the erased one are renumbered.

Example: Erasing track 2.

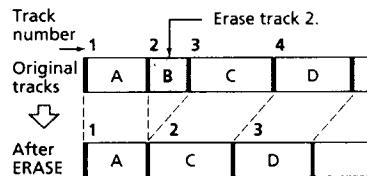

All the tracks following the erased one are renumbered, so when erasing multiple tracks (e.g., tracks 2, 5 and 6), we recommend erasing from the higher numbered tracks.

Erasing recordings (continued)

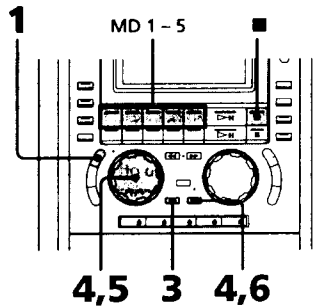

- 1** Press FUNCTION repeatedly to switch the function to MD.
- 2** Press MD D.SKIP on the remote repeatedly until the button of the desired MD lights green.
If the MD appears in the slot, press ▲ to load the MD (to the recording/playing unit).
- 3** Press MENU/NO so that "Edit Menu" appears.
- 4** Turn MULTI JOG until "Tr Erase ?" appears, then press ENTER/YES. The MD deck starts playing the displayed track.
- 5** Turn MULTI JOG until the desired track number appears.

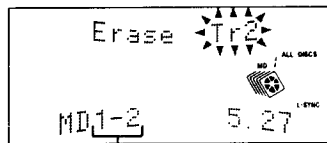

Desired track number

- 6** Press ENTER/YES.
"Complete!!" appears for a few seconds and the selected track and title are erased. The MD deck starts playing the track following the erased track.

To cancel the Tr Erase Function

Press ■ for the MD.

To return to the condition before erasing

You can return to the original condition immediately after erasing a track (see page 61).

Note

"Tr Erase ???" appears when the track was recorded or edited on another deck and is record protected. To erase the track, press ENTER/YES while "Tr Erase ???" is displayed.

Erasing all tracks (All Erase Function)

You can erase the disc title, all recorded tracks and their titles at once.

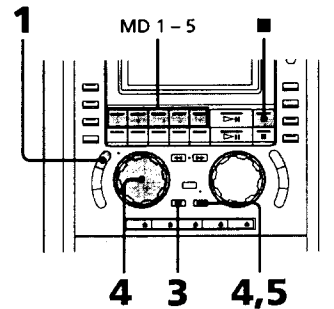

- 1** Press FUNCTION repeatedly to switch the function to MD.

- 2 Press MD D.SKIP on the remote repeatedly until the button of the desired MD lights green.
If the MD appears in the slot, press \blacktriangle to load the MD (to the recording/playing unit).
- 3 Press MENU/NO so that "Edit Menu" appears.
- 4 Turn MULTI JOG until "All Erase?" appears, then press ENTER/YES. "All Erase?" appears.
- 5 Press ENTER/YES again. "Complete!!" appears for a few seconds and the disc title, all recorded tracks and their titles are erased.

To cancel the All Erase Function

Press \blacksquare for the MD.

To return to the condition before erasing

You can return to the original condition immediately after erasing tracks (see page 61).

Erasing a portion of a track (A-B Erase Function)

You can specify a portion within a track and erase the portion with ease. You can shift the desired portion by frame*, minute or second intervals. This function is convenient when erasing unnecessary sections after recording a satellite broadcast or FM broadcast.

* 1 frame is 1/86 second.

Example: Erasing a portion of track 2.

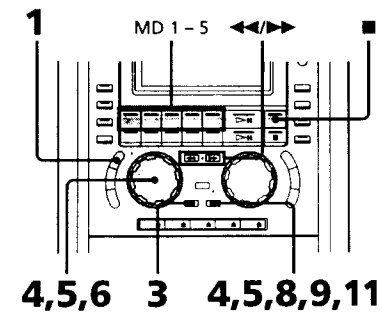
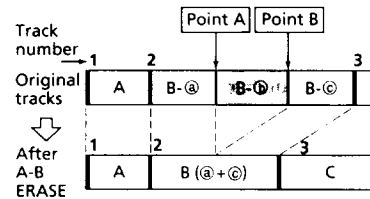

- 1 Press FUNCTION repeatedly to switch the function to MD.
- 2 Press MD D.SKIP on the remote repeatedly until the button of the desired MD lights green.
If the MD appears in the slot, press \blacktriangle to load the MD (to the recording/playing unit).
- 3 Press MENU/NO so that "Edit Menu" appears.
- 4 Turn MULTI JOG until "A-B Erase?" appears, then press ENTER/YES.

Erasing recordings (continued)

- 5** Turn MULTI JOG until the desired track number appears, then press ENTER/YES.
“-Rehearsal-” and “Point A ok?” appear alternately while the deck plays the selected track from the beginning.

- 6** While monitoring the sound, turn MULTI JOG to select the starting point of the portion to be erased (point A).

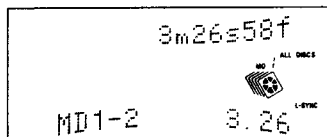

You can shift the starting point by 1/86 second (1 frame) intervals.

To shift the point by second or minute intervals, press ◀ or ▶ so that “s” or “m” flashes, then turn MULTI JOG.

- 7** If the point A is still incorrect, repeat step 6 until it is correct.
- 8** Press ENTER/YES when the position is correct.
“Point B Set” appears in the display and play for setting the ending point of the portion to be erased (point B) starts.

- 9** Continue play (or press ◀◀ or ▶▶) until the deck reaches point B, then press ENTER/YES.

“A-B Ers” and “Point B ok?” appear alternately and the deck repeats the few seconds before point A and after point B successively.

- 10** Repeat step 6 if point B is not correct.

- 11** Press ENTER/YES when the position is correct.

“Complete!!” appears for a few seconds and the portion between point A and B is erased.

To cancel the A-B Erase Function

Press ■ for the MD.

To return to the condition before erasing

You can return to the original condition immediately after erasing the A-B portion (see page 61).

Note

- If “Impossible” appears in the display, this means:
- You specified a point B that comes before point A. Point B should be after point A.
 - The specified portion cannot be erased. This sometimes happens when you have edited the same track many times. This is due to a technical limitation of the MD system and is not a mechanical error.

Moving recorded tracks

— Move Function

This function lets you change the order of any track on the disc. When you move tracks, the tracks are automatically renumbered.

Example: Moving track 3 to position 2.

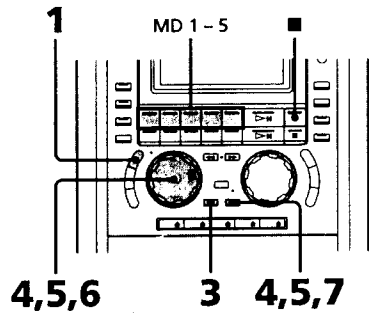
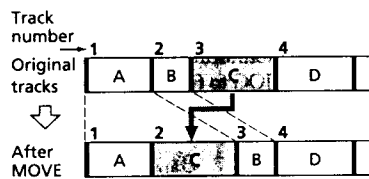

- 1 Press FUNCTION repeatedly to switch the function to MD.
- 2 Press MD D.SKIP on the remote repeatedly until the button of the desired MD lights green.
If the MD appears in the slot, press ▲ to load the MD (to the recording/playing unit).
- 3 Press MENU/NO so that "Edit Menu" appears.

- 4 Turn MULTI JOG until "Move?" appears, then press ENTER/YES.
- 5 Turn MULTI JOG until the desired track number appears, then press ENTER/YES.
- 6 Turn MULTI JOG until the new track position appears.

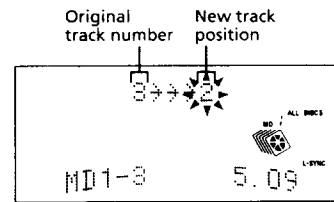

- 7 Press ENTER/YES.
"Complete!!" appears for a few seconds and the tracks are moved.

To cancel the Move Function

Press ■ for the MD.

To return to the track order before MOVE

You can return to the original track order immediately after moving recorded tracks (see page 61).

Dividing recorded tracks

— Divide Function

This function lets you mark track numbers after the recording ends. The total number of tracks increases by one and all the tracks following the divided ones are renumbered.

Example: Dividing track 2 into two tracks.

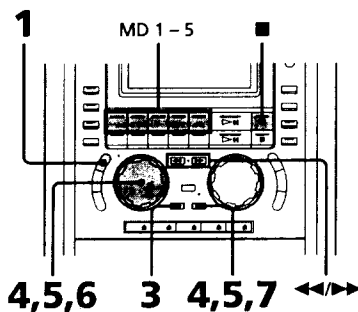
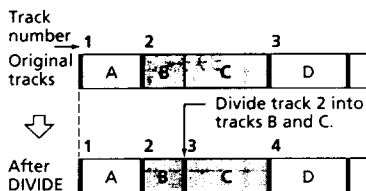

- 1 Press FUNCTION repeatedly to switch the function to MD.
- 2 Press MD D.SKIP on the remote repeatedly until the button of the desired MD lights green.
If the MD appears in the slot, press \blacktriangle to load the MD (to the recording/playing unit).

- 3 Press MENU/NO so that "Edit Menu" appears.
- 4 Turn MULTI JOG until "Divide?" appears, then press ENTER/YES.
- 5 Turn MULTI JOG until the desired track number appears, then press ENTER/YES.
"-Rehearsal-" appears and the portion to be divided is played repeatedly.
- 6 While monitoring the sound, turn MULTI JOG to find the point to be divided.

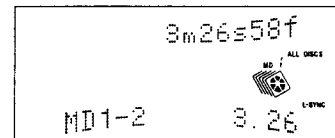

You can shift the point by 1/86 second (1 frame) intervals.
To shift the point by second or minute intervals, press \leftarrow or \rightarrow so that "s" or "m" flashes, then turn MULTI JOG.

- 7 Press ENTER/YES, when the position is correct.
"Complete!!" appears for a few seconds and the newly created track begins playing.

To cancel the Divide Function

Press \blacksquare for the MD.

Notes

- When you divide a labeled track (see page 51), only the first of the two tracks retains the track title.

Example:

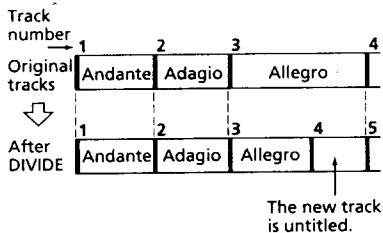

- You cannot divide the start or end of a track. If you specify the start or end of a track as the position to be divided, "Impossible" appears. Turn MULTI JOG to shift the position.

To return to the condition before DIVIDE

You can return to the original condition immediately after dividing the tracks (see page 61). You can also return to the original condition by using the Combine Function.

Combining recorded tracks

— **Combine Function**

This function lets you put several tracks or several independently recorded portions into a single track. The total number of tracks decrease accordingly and all the tracks following the combined ones are renumbered.

Example: Combining track 3 to track 1.

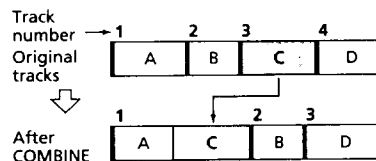

Example: Combining track 1 to track 4.

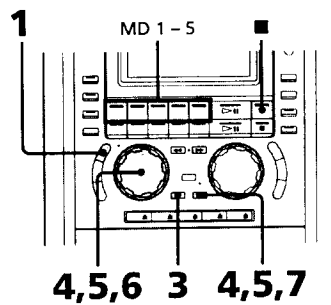
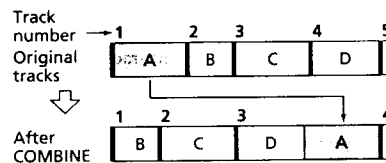

Editing an MD

**Combining recorded tracks
(continued)**

- 1 Press FUNCTION repeatedly to switch the function to MD.
- 2 Press MD D.SKIP on the remote repeatedly until the button of the desired MD lights green.
If the MD appears in the slot, press \blacktriangle to load the MD (to the recording/playing unit).
- 3 Press MENU/NO so that "Edit Menu" appears.
- 4 Turn MULTI JOG until "Combine ?" appears, then press ENTER/YES.
- 5 Turn MULTI JOG until the number of the first track of the two to be combined appears, then press ENTER/YES.
For example, to combine tracks 4 and 1, select track 4.

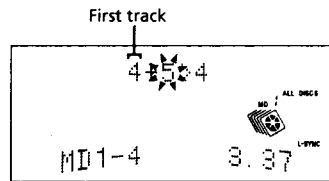

- 6 Turn MULTI JOG until the number of the second track of the two to be combined appears.

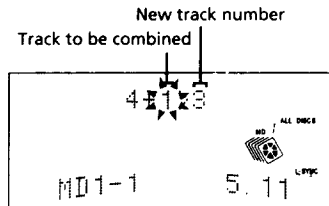

- 7 Press ENTER/YES.
"Complete!" appears for a few seconds and the combined tracks start playing.

To cancel the Combine Function

Press \blacksquare for the MD.

To return to the condition before COMBINE

You can return to the original condition immediately after combining the tracks (see the next page). You can also return to the original condition by using the Divide Function.

Notes

- If both of the combined tracks have track titles, the title of the second track is erased.

Example:

Track number	1	2	3	4
Original tracks	Andante	Adagio	Allegro	
After COMBINE	1	2	3	
	Andante	Adagio		

The second track title is erased.

- If "Impossible" appears, the tracks cannot be combined. This sometimes happens when you have edited the same track many times. This is due to a technical limitation of the MD system and is not a mechanical error.

Undoing the last edit

— Undo Function

You can cancel the last edit and restore the contents of the MD to the condition before the edit.

Note, however, that you cannot undo an edit if you do any of the following after the edit:

- Do another edit.
- Press REC.
- Press REC IT.
- Press ENTER/YES, after pressing SELECT SYNC, SEAMLESS, HIT PARADE or MD WALKMAN SYNC.
- Update the TOC by turning off the system or ejecting the MD.
- Disconnect the AC power cord.

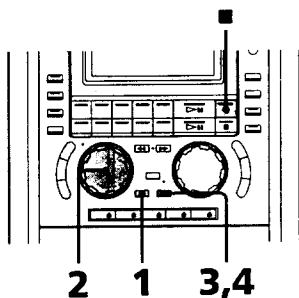

1 Press MENU/NO while the deck is stopped so that "Edit Menu" appears.

2 Turn MULTI JOG until "Undo ?" appears.
When there is no editing function that can be canceled, "Undo ?" is not displayed.

3 Press ENTER/YES.
One of the following messages appears, depending on the last edit.

Editing done:	Message:
Labeling an MD or a track	
Copying a disc title or a track title	"Name Undo?"
Erasing labeled titles	
Erasing a single track	
Erasing all tracks on an MD	"Erase Undo?"
Erasing a portion of a track	
Moving a track	"Move Undo?"
Dividing a track	"Divide Undo?"
Combining tracks	"Combine Undo?"

4 Press ENTER/YES again.
"Complete!!" appears for a few seconds and the contents of the MD are restored to the condition before the edit.

To cancel the Undo Function

Press ■ for the MD.

Adjusting the Sound

Getting a more powerful sound

You can listen to music with stronger bass tones or more powerful sound.

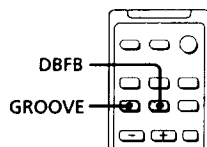

Reinforcing the bass

- Press DBFB*.
"DBFB" appears in the display, and the bass is reinforced.

* DBFB: Dynamic Bass Feedback

For a powerful sound (GROOVE)

- Press GROOVE.
The GROOVE button lights up.
The volume increases and the bass is reinforced (DBFB is also turned on).
Press the button again to cancel GROOVE.
DBFB is also canceled.

Tip
DBFB and GROOVE are factory set to on.

Selecting a sound effect

— Preset Equalizer

The Preset Equalizer lets you select the sound characteristics from among 10 sound effects according to the type of music and the listening environment.

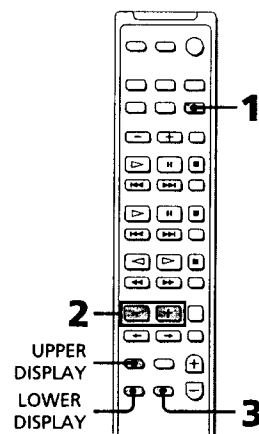

- 1 Press PRESET EQ.
- 2 Press MENU/PRESET EQ +/- repeatedly (or turn MULTI JOG on the system) until the effect you want appears.

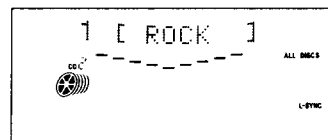

- 3 Press ENTER/YES.

To cancel the Preset Equalizer

Press PRESET EQ again in step 2.

To change the spectrum analyzer display

Press UPPER DISPLAY and LOWER DISPLAY at the same time. Each time you press the buttons, the display changes as follows:

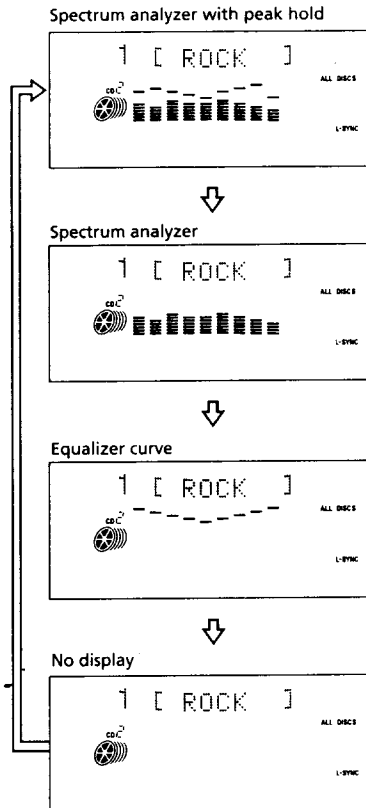

- Tips**
- The Preset Equalizer menu is factory set to "1 [ROCK]".
 - The Preset Equalizer effect is not recorded on an MD or a tape.

Timer

Falling asleep to music

— *Sleep Timer*

You can have the system turn off at a preset time, so you can fall asleep to music. You can preset the time to turn off in 10 minute intervals.

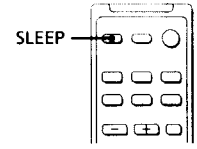

➔ Press SLEEP. Each time you press the button, the minute display (the turn-off time) changes as follows:

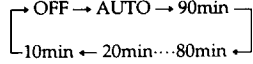

To check the remaining time

Press SLEEP once.

To change the time to turn off

Press SLEEP repeatedly to select the desired time.

To cancel the Sleep Timer operation

Press SLEEP repeatedly until "OFF" appears.

If you select "AUTO"

The system automatically turns off when the current CD, MD or tape (only when using the optional TC-PX100 tape deck) finishes playing. The system also turns off when you press ■ and stop play. When a different sound source is selected (e.g., TUNER), the system turns off after about 4 hours.

Tip

You do not have to set the clock to use the Sleep Timer.

Waking up to music

— Daily Timer

You can wake up to music at a preset time. Make sure you have set the clock first (see page 8).

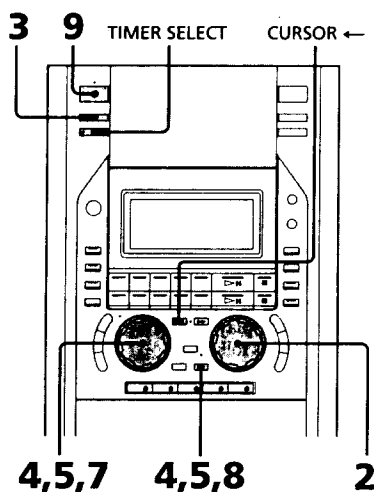

- 1 Prepare the sound source you want to play.
 - CD: Place the desired CD in the tray. If "SHUFFLE" or "PROGRAM" appears in the display, press PLAY MODE so that these indications disappear.
 - MD: Insert the desired MD. If "SHUFFLE" or "PROGRAM" appears in the display, press PLAY MODE so that these indications disappear.
 - Radio: Tune in the desired preset station (see page 21).
 - Tape: Insert a tape in the optional tape deck.

- 2 Turn VOLUME to adjust the volume.

- 3 Press CLOCK/TIMER SET.

- 4 Turn MULTI JOG until "DAILY SET ?" appears, then press ENTER/YES. The hour indication flashes.

- 5 Set the time to start playing. Turn MULTI JOG to set the hour, then press ENTER/YES. The minute indication flashes. The clock is on a 24-hour system for the European model, and a 12-hour system for other models.

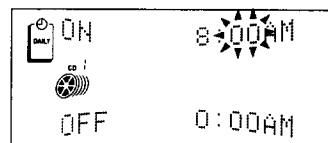

Turn MULTI JOG to set the minute, then press ENTER/YES. The hour indication flashes again.

- 6 Set the time to stop playing following the procedure in step 5. The sound source indication appears.

- 7** Turn MULTI JOG until the sound source you want appears.
The indications change as follows:

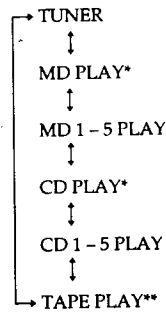

- * The selected MD or CD (MD whose MD 1 - 5 button or CD whose CD 1 - 5 button is lit green) starts playing.
- ** Select "TAPE PLAY" to use an optional component connected to the TAPE jacks as the sound source.

- 8** Press ENTER/YES.
"DAILY TIMER" appears in the display.
The start time, the stop time, the sound source and the volume appear in turn before the original display returns.

- 9** Turn off the system.

To change the setting

Start over from step 1.

If you made a mistake, press CURSOR ← and return to the point you want to change during steps 5 to 7, then change the setting.

To check the setting/activate the timer

- 1 Press TIMER SELECT, then turn MULTI JOG until "DAILY SELECT ?" appears.
- 2 Press ENTER/YES.
"DAILY TIMER" appears in the display.
The start time, the stop time, the sound source and the volume appear in turn before the original display returns.

To cancel the timer operation

- 1 Press TIMER SELECT, then turn MULTI JOG until "TIMER OFF ?" appears.
- 2 Press ENTER/YES.
"DAILY" disappears from the display and the timer operation is canceled.

Tip

When you connect the optional TC-PX100 tape deck to the system (see page 78), the tape deck is automatically turned on by the system's timer. This lets you wake up to the tape without setting the deck timer.

Notes

- You cannot use the Daily Timer at the same time as the Recording Timer (REC).
- Do not operate the system from the time the system turns on until the play starts (about 30 seconds before the preset time). If you do so, the timer may not operate correctly.
- If the power is on at the time to turn on, the set sound source starts playing.
- Optional components other than the TC-PX100 tape deck are not turned on by the Daily Timer. When using these components as the sound source, make the same timer settings on the component side.
- If the timer-on and -off settings are the same, "OFF TIME NG !" appears and the cursor returns to the timer-off setting. Change the time to turn off.

Timer-recording radio programs

This system has five recording timers, and you can set all five timers at the same time. You can also timer-record up to 5 MDs, letting you timer-record a 2-hour program. Make sure you have preset the radio station (see page 10) and set the clock beforehand (see page 8).

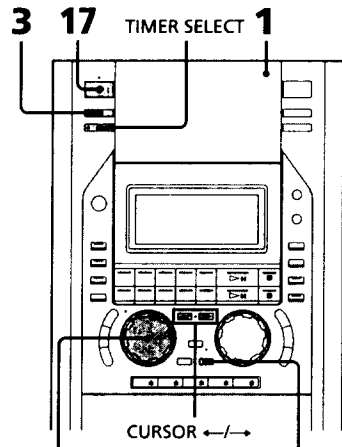

3,5,7,9, 11,13,15 **4,6,8,10, 11,14,16**

- 1** Insert recordable MDs.
You can record on any of the MDs in MD 1 - 5. Insert multiple MDs to record for long times. Recording starts in order from MD 1.
If the MD has been partially recorded, recording starts after the re-ordered tracks.
- 2** Tune in the preset radio station (see page 21).

- 3** Press CLOCK/TIMER SET, then turn MULTI JOG until "REC SET ?" appears.



- 4** Press ENTER/YES.
- 5** Turn MULTI JOG to select one of "REC 1 ?" to "REC 5 ?".



- 6** Press ENTER/YES.
- 7** Turn MULTI JOG until "ONCE", "DAILY" or "WEEKLY" appears.
If you select "ONCE", the recording timer activates only once. If you select "DAILY", the timer activates at the same time every day. If you select "WEEKLY", the timer activates at the same time on the set day of every week.

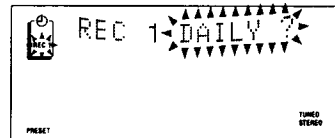

- 8** Press ENTER/YES.
If you select "ONCE" or "WEEKLY", the day indication starts flashing. If you select "DAILY", the hour indication starts flashing.

- 9** Turn MULTI JOG to select the desired day.
If you select "DAILY" in step 7, proceed to step 11.

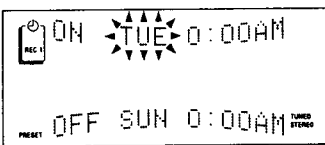

- 10** Press ENTER/YES.
The hour indication flashes.

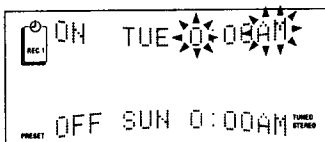

For models using a 12-hour system, noon is indicated as 0:00 PM, and midnight as 0:00 AM.

- 11** Set the time to start recording.
Turn MULTI JOG to set the hour, then press ENTER/YES.
The minute indication flashes.

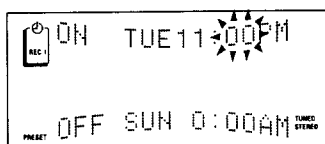

Turn MULTI JOG to set the minute, then press ENTER/YES.
The hour indication flashes again.

- 12** Set the time to stop recording following the procedure in step 11.

- 13** Turn MULTI JOG to select the recording destination.
As you turn MULTI JOG, the display changes as follows:

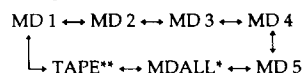

- * When you want to record on multiple MDs sequentially, select "MDALL" and go to step 16.
- ** When recording on a tape with the optional TC-PX100 tape deck, select "TAPE".

- 14** Press ENTER/YES.
"STEREO REC ?" appears.

- 15** Turn MULTI JOG to select "STEREO" or "MONO".
STEREO REC: Stereo recording
MONO REC: Monaural recording

- 16** Press ENTER/YES.
The timer number (REC 1 to REC 5), the timer type (ONCE, DAILY or WEEKLY), the start time, the stop time, the recording source, the recording destination and the recording method (STEREO or MONO) appear in turn before the original display returns.

- 17** Turn off the system.

Timer

**Timer-recording radio programs
(continued)**

To change the setting

Start over from step 1.
If you made a mistake, press CURSOR ← and return to the point you want to change during steps 9 to 15, then change the setting.

To activate/cancel the timer

- 1 Press TIMER SELECT, then turn MULTI JOG until "REC SELECT ?" appears and press ENTER/YES.
- 2 Turn MULTI JOG to select ON (set) or OFF (cancel), then select the timer number with CURSOR ← or → and press ENTER/YES.

To check the timer

Select "ON" for the desired timer number (REC 1 to REC 5) in step 2 of "To activate/cancel the timer", then press ENTER/YES. The last setting appears.

If the set times overlap

The shaded portions are not recorded.

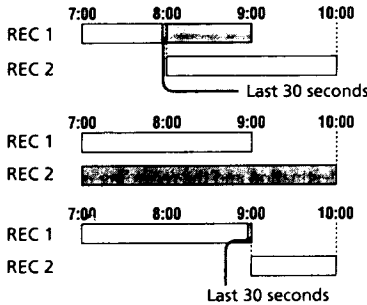

Tips

- When you record from the radio, the Station Name (see the next page, or the frequency if the station is not labeled) is recorded on the MD along with the start and stop times.
- The recording time for monaural recording is roughly double that for stereo recording.

Notes

- When you record a long program on multiple MDs (if you selected "MDALL" in step 13), the sound is not recorded while the system is switching MDs. If all the program cannot fit on MD 1, recording starts automatically from the next MD. Be sure to insert recordable MDs beforehand and remove any unwanted MDs from the slots.
- Do not operate the system from the time the power turns on until the recording starts (about 30 seconds before the preset time). If you do so, the timer may not operate correctly.
- If the timer-on and -off settings are the same, "OFF TIME NG!" appears and the cursor returns to the timer-off setting. Change the time to turn off.
- When you use a brand new MD to record, the first 30 seconds will not be recorded.
- If the power is on 30 seconds before the preset time, the timer-recording may not be activated. Make sure you finish the settings at least 30 seconds before the preset time, then turn off the system.
- The volume is reduced to minimum during recording.
- The Smart Space and Level Synchro Recording features do not operate.

Other Features

Labeling the preset stations

— Station Name

You can assign a name of up to 10 characters (Station Name) to a preset station. The Station Name appears when you tune in the preset station.

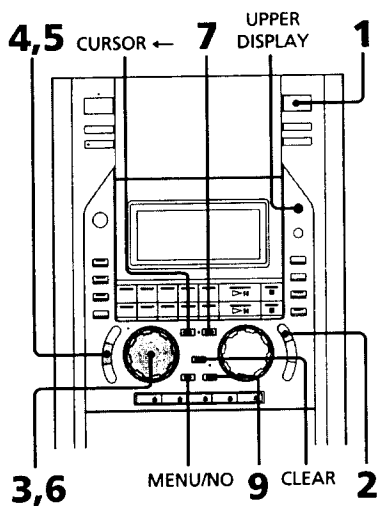

- 1 Press TUNER/BAND (or BAND on the remote) repeatedly until the band you want appears.

North American model:

→ FM → AM

European model:

→ FM → MW → LW

Other models:

→ FM → MW → SW

- 2 Press TUNING MODE repeatedly until "PRESET" appears.
- 3 Turn MULTI JOG until the preset number of the station you want to label appears.
- 4 Press NAME EDIT/CHARACTER. The text input screen appears, and the cursor flashes.

Cursor

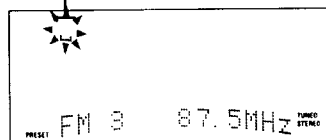

- 5 Press NAME EDIT/CHARACTER so that the desired type of character appears. Each time you press the button, the display changes as follows:
A (Upper cases) → a (Lower cases)
→ 0 (Numbers) → ! (Symbols)
→ [] (Blank space) → A → ...
- 6 Turn MULTI JOG until the character you want appears.

To enter a blank space

Press CURSOR → without turning MULTI JOG.

To enter a symbol

You can use the following 24 symbols:
! " # \$ % & ' () * + , - . / : ; < = > ? @ _

**Labeling the preset stations
(continued)**

- 7** Press CURSOR → to enter the character.
The cursor shifts rightward and waits for the input of the next character.

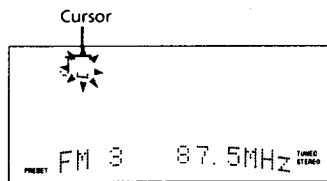

- 8** Repeat steps 5 to 7 to complete the name.

If you made a mistake

Press CURSOR ← or → until the character you want to change flashes, then repeat steps 5 to 7.

To erase the character

Press CLEAR. Each time you press the button, the character at the position of the cursor is erased.
You cannot insert characters.

- 9** Press ENTER/YES to complete the labeling procedure.
The name is stored in the system memory.

To cancel labeling

Press MENU/NO.

To check the Station Name of the current station

Press UPPER DISPLAY.
Each time you press the button, the display changes as follows:

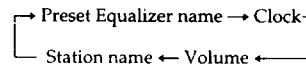

To erase the name

Start over from step 1, then press CLEAR repeatedly after step 4 to erase the name.

Using the Radio Data System (RDS)

(European model only)

What is the Radio Data System?

Radio Data System (RDS) is a broadcasting service that allows radio stations to send additional information along with the regular program signal. This tuner offers a convenient RDS feature, locating a station by program type (PTY). RDS is available only on FM stations*.

Note

RDS may not work properly if the station you are tuned to is not transmitting the RDS signal properly or if the signal strength is weak.

* Not all FM stations provide RDS service, nor do they provide the same types of services. If you are not familiar with the RDS system, check with your local radio stations for details on RDS services in your area.

Receiving RDS broadcasts

- ➔ Simply select a station from the FM band.
- When you tune in a station that provides RDS services, the station name appears in the display.

To check the RDS information

Each time you press UPPER DISPLAY, the display changes as follows:

- ➔ Preset Equalizer name
- ↓
- Clock
- ↓
- Volume
- ↓
- Station name
- ↓
- PTY*

* The display returns to the Preset Equalizer name display after about 8 seconds.

Note

"No PTY Data" appears when the received station does not broadcast the program type.

Locating a station by program type (PTY)

You can locate a station by selecting a program type. The system tunes in the type of program currently being broadcast from the RDS stations stored in the tuner's preset memory.

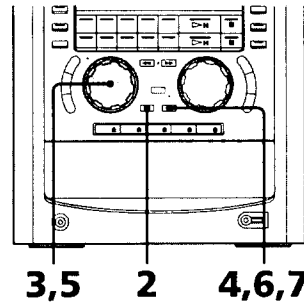

- 1 Tune in an RDS station.
- 2 Press MENU/NO.
- 3 Turn MULTI JOG until "PTY Search?" appears.
- 4 Press ENTER/YES.
- 5 Turn MULTI JOG until the desired program type appears. See "List of program types (PTY)".

**Using the Radio Data System (RDS)
(continued)**

- 6** Press ENTER/YES.
The system starts searching for the preset RDS stations.
When the tuner receives a program, the preset station number flashes.
- 7** Press ENTER/YES when the tuner receives the desired program.

To select another station from the desired program type

In step 7, turn MULTI JOG again and continue from step 5.

To cancel PTY Search

Press MENU/NO. The system tunes in the station you were listening to before.

List of program types (PTY)

News

News programs.

Affairs

Topical programs that expand on current news.

Information

Programs about consumer affairs and medical advice.

Sport

Sports programs.

Education

Educational programs, such as "how-to" programs and advice.

Drama

Radio plays and serials.

Culture

Programs about national or regional culture, language, and societal concerns.

Science

Programs about the natural sciences.

Varied Speech

Programs containing celebrity interviews, panel games, and comedy.

Pop Music

Popular music programs.

Rock Music

Rock music programs.

Easy Listening

Easy listening (middle of the road music).

L. Classical

Classical music, such as instrumental, vocal and choral works.

S. Classical

Performances of major orchestras, chamber music, opera, etc.

Other Music

Music, such as rhythm and blues, and reggae.

Weather

Weather information.

Finance

Stock market reports and trading, etc.

Children ('s programs)

Programs for the young.

Social Affairs

Programs about people and the things that affect them.

Religion

Programs of religious content.

Phone In

Programs where members of the public express their views by phone or in a public forum.

Travel

Programs about travel. Not for announcements that are located by TP/TA.

Leisure

Programs on recreational activities such as gardening, fishing, cooking, etc.

Jazz Music

Jazz programs.

Country Music

Country music programs.

National Music

Programs featuring the popular music of the country or region.

Oldies Music

Programs featuring oldies music.

Folk Music

Folk music programs.

Documentary

Investigative features.

Alarm Test

Used only for dynamic switching.

Alarm - Alarm

Emergency broadcasts.

None

Any programming not defined above.

Notes

- "PTY not found" appears when the program you selected is not currently being broadcast.
- "PTY change" appears when the program type you selected has ended while PTY scanning. You will receive another station if it broadcasts the same type of program.

Using Optional Equipment

List of compatible components

This section describes components that can be connected to the system; these components are listed below. Be sure to confirm the jacks and the FUNCTION. For details on the connections and operation, refer to the descriptions on the following pages. Also refer to the operating instructions provided with each component.

Component	Jack	FUNCTION
MD WALKMAN*	MD WALKMAN* LINK	MD WALKMAN
Tape deck	TAPE IN/OUT	TAPE
DVD player	DVD/VIDEO IN	DVD
TV	DVD/VIDEO IN	VIDEO
VCR	DVD/VIDEO IN	VIDEO

* "MD WALKMAN" is a trademark of Sony Corporation.

► MD WALKMAN

Connecting an MD WALKMAN

You can connect a Sony portable MiniDisc recorder/player "MD WALKMAN" to the system using the supplied MD WALKMAN LINK cable.

To use an MD WALKMAN, refer to the operating instructions for the MD WALKMAN.

Note

Never connect any components other than those listed below to the MD WALKMAN LINK jack. Doing so could result in malfunction.

• Models that can be connected:

Portable MiniDisc recorder:

MZ-R5ST* (Europe only), R50, R30

Portable MiniDisc player:

MZ-E45 (Hong Kong only), E44, E35, E30, E25, EP11

* Be sure to remove the MD WALKMAN from the station and connect only the MD WALKMAN to the system.

• Features:

The system starts recording automatically in sync with MD WALKMAN play (synchro recording). The sound from the MD WALKMAN is recorded as an analog signal to the MD deck. In addition, if you use a portable MiniDisc player, you can copy the track title of the current track and mark track numbers automatically.

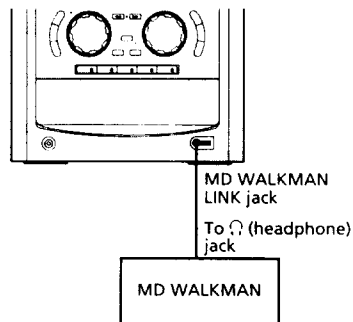

- 1 If the power is on, press I/O (power) to turn off this system.
- 2 Turn off the MD WALKMAN's Mega Bass function. Set the DIGITAL MEGA BASS switch to "0", or press DIGITAL MEGA BASS so that "BASS" disappears from the display.
- 3 Turn on the MD WALKMAN's AVLS (volume limiting) function. Set the AVLS switch to "LIMIT" or "ON".
- 4 Play the MD WALKMAN.
- 5 Press DISPLAY on the MD WALKMAN repeatedly to display the playing time and track number on the remote. (This information appears on the main unit for the MZ-R30.)

The MD WALKMAN is designed so that the playing time and track number information is output from the remote jack.

Connecting an MD WALKMAN (continued)

- 6 Use the remote for the MD WALKMAN to set the volume to the highest setting.
- 7 Disconnect the remote for the MD WALKMAN and connect the MD WALKMAN to the system.
Connect the end with the loop to the MD WALKMAN.

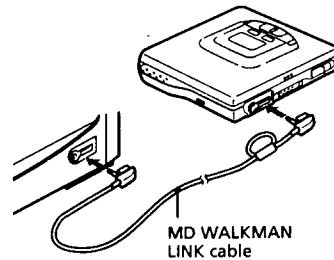

Notes

- Do not place the MD WALKMAN on top of the system. The sound may drop out or noise may occur. Doing so could also result in malfunction.
- If the Mega Bass function is on, or the AVLS function is off, the sound may be distorted during MD WALKMAN play.
- If you connect the MD WALKMAN to the system while the power is on, electronic noise may occur, resulting in misoperation. Always be sure to turn the system off before connecting the MD WALKMAN.
- When you connect an MD WALKMAN to the system, the MD WALKMAN consumes more power than during normal play. Make sure the battery level is sufficient before starting recording.

Recording from an MD WALKMAN

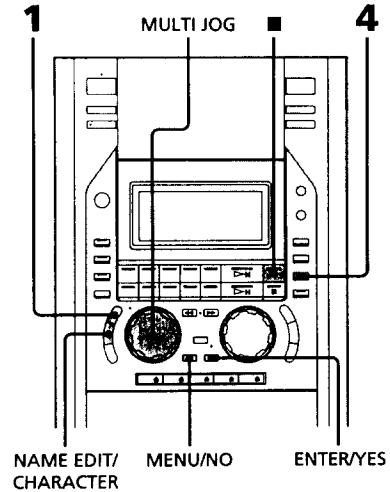

- 1 Press **FUNCTION** repeatedly until "MD WALKMAN" appears.
- 2 Set the MD WALKMAN to playing pause mode.
If your MD WALKMAN does not have a playing pause function, set the MD WALKMAN to stop mode.
- 3 Press **◀▶** or **▶▶** on the MD WALKMAN repeatedly to select the track to be recorded.
Note
You can select tracks only for models with the **◀▶/▶▶** button (except for models on which these buttons also function as the **▶** button).
- 4 Press **MD WALKMAN SYNC**.
The MD in the slot is automatically pulled in and the MD deck stands by for recording.

- 5** Press **▶** on the MD WALKMAN. The MD WALKMAN starts playing and the system starts recording simultaneously to the MD. When recording is complete, press **■** for the MD on the system first, then press **■** on the MD WALKMAN to stop recording.

To stop recording

Press **■** for the MD on the system first, then press **■** on the MD WALKMAN. The sound from the speakers drops out momentarily and the recording stops.

Before pulling out the power cord

MD recording is completed when the MD Table of Contents (TOC) is updated. The TOC is updated when you eject the MD or press **I/O** (power) and turn off the system. Do not pull out the power cord before updating the TOC (while "TOC" is lit) or while updating the TOC (while "TOC" is flashing) to ensure the complete recording.

Notes

- If you start MD WALKMAN SYNC recording with the MD WALKMAN set to stop mode, silence may be recorded for the first few seconds until the MD WALKMAN starts playing.
- When you stop or pause the recording, the sound from the speakers may drop out for up to about 3 seconds, but this does not indicate a malfunction.
- The Smart Space and Level Synchro Recording features do not operate.

Adjusting the recording level

You can adjust the recording level by doing the following operations after step 3.

- 1** Press **MENU/NO** twice so that "Setup Menu" appears.
- 2** Turn **MULTI JOG** until "Level Adjust?" appears.
- 3** Press **ENTER/YES**.
- 4** Turn **MULTI JOG** to select the desired recording level.
- 5** Press **MENU/NO**.

Copying track titles

When you record from a portable MiniDisc player, you can copy the title of the current track.

Models:

MZ-E45 (Hong Kong only), E44, E35, E30, E25, EP11

- 1** While recording, press **NAME EDIT/CHARACTER**.

If the current track has a title, the title appears.

If the track does not have a title, you can input a track title. (To input a track title, do steps 4 to 7 on pages 51 and 52.)

- 2** Press **ENTER/YES**.

The displayed track title is copied.

To copy track titles after editing, perform steps 1 to 8 in "Labeling an MD" (page 51).

Notes

- If you start recording from part-way through a track, the track title may not be copied.
- If you copy track titles with a portable MiniDisc recorder (MZ-R5ST (Europe only), R50, R30), incorrect characters may appear.

Marking track numbers

Press **REC** while recording at the point you want to add a track mark.

A track number is marked at that point.

Tip

When you record from a portable MiniDisc player, the track numbers are automatically marked as on the MD in the player.

Notes

- When you record from a portable MiniDisc recorder, the track numbers may not be marked as on the MD in the recorder. In these cases, use the edit function to remark the track numbers after you finish the recording.
- The Level Synchro Recording feature does not operate while recording the sound from the MD WALKMAN.

► Other A/V Components

Connecting a tape deck, VCR, etc.

To enhance your system, you can connect optional components. Analog sound from the connected component is recorded as an analog signal on the MD. Refer to the operating instructions of each component.

Connecting the audio cords (not supplied)

When using audio cords (not supplied) to connect other AV components to the system, make sure to insert the plugs firmly, pushing them in all the way. No sound will be produced if the plugs are not inserted securely.

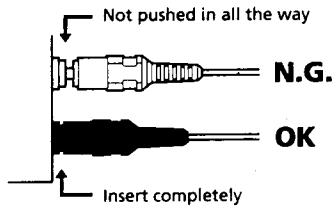

Connecting the optional TC-PX100 tape deck

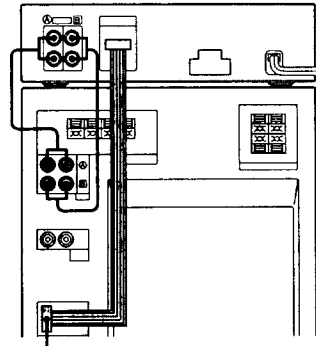

CD Synchro Recording and Timer Recording are possible when the TAPE CONTROL jacks are connected.

Refer to the operating instructions included with the TC-PX100 tape deck for details.



TAPE CONTROL jack

Tip

The  and  markings of the TAPE IN/OUT jacks guide you to connect the optional TC-PX100 tape deck.

Connecting another tape deck

Connect the tape deck to the TAPE IN and OUT jacks on the rear panel of the system.

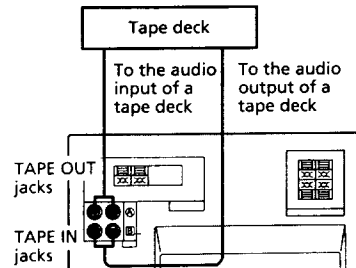

Connecting a TV, VCR, DVD player, etc.

Connect the component to the DVD/VIDEO IN jacks on the system.

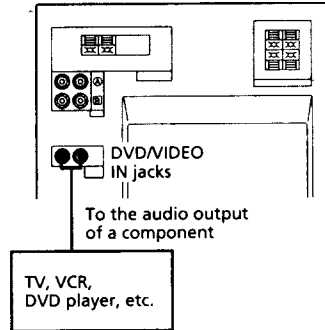

Tip

The system does not support Dolby Pro Logic, so you cannot listen to material played back on a DVD player with Dolby Digital or Dolby Pro Logic. In addition, this system cannot make a digital recording from a disc that was recorded with Dolby Digital.

* DOLBY, the double-D symbol , the Dolby Digital and "PRO LOGIC" are trademarks of Dolby Laboratories Licensing Corporation.

Listening to the sound of connected A/V components

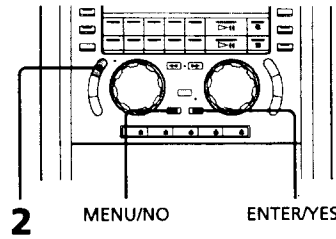

1 Prepare the connected analog component.

2 Press FUNCTION repeatedly to select "TAPE" or "VIDEO".

Sound source	FUNCTION
Tape deck	TAPE
TV	VIDEO
VCR	VIDEO
DVD player	DVD*

* To select "DVD", press FUNCTION repeatedly to select "VIDEO" then press MENU/NO and press ENTER/YES. The maximum level of the signals output by a DVD player is different from that of other analog components, so always be certain to switch to "DVD" when listening to sound from a DVD player.

Furthermore, to change back to "VIDEO" when changing the connected component from the DVD player to a VCR or other such component, press FUNCTION repeatedly to select "DVD", then press MENU/NO and press ENTER/YES. Failure to change the FUNCTION setting before using the VCR or other such component may result in malfunction.

Recording the sound of connected A/V components

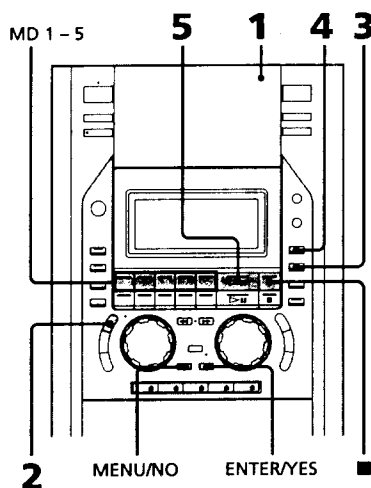

- 1 Insert a recordable MD.
- 2 Press FUNCTION repeatedly to select "TAPE" or "VIDEO".

Sound source	FUNCTION
Tape deck	TAPE
TV	VIDEO
VCR	VIDEO
DVD player	DVD*

* To select "DVD", press FUNCTION repeatedly to select "VIDEO" then press MENU/NO and press ENTER/YES. The maximum level of the signals output by a DVD player is different from that of other analog components, so always be certain to switch to "DVD" when listening to sound from a DVD player.

Furthermore, to change back to "VIDEO" when changing the connected component from the DVD player to a VCR or other such component, press FUNCTION repeatedly to select "DVD", then press MENU/NO and press ENTER/YES. Failure to change the FUNCTION setting before using the VCR or other such component may result in malfunction.

- 3 Press REC MODE repeatedly until "1DISC" appears.
The MD whose MD 1 - 5 button is lit green is recorded.
To record in monaural format, select "MONO".
- 4 Press REC.
The MD deck stands by for recording.
- 5 Press ▷|| for the MD.
Recording starts.
- 6 Play the desired sound source.

To stop recording

Press ■ for the MD.

Tip

You can adjust the recording level to the desired volume after performing step 4. (See page 48.)

To record with the tape deck

Do the procedure in "Listening to the sound of connected A/V components" (see page 79) to listen to the broadcast, then start recording with the tape deck.

Before pulling out the power cord

MD recording is completed when the MD Table of Contents (TOC) is updated. The TOC is updated when you eject the MD or press I/O (power) and turn off the system. Do not pull out the power cord before updating the TOC (while "TOC" is lit) or while updating the TOC (while "TOC" is flashing) to ensure the complete recording.

► **FM/AM Antenna**

Connecting commercially available antennas

You can connect commercially available antennas to improve the reception.

FM antenna

Connect the commercially available FM outdoor antenna.

Jack type Ⓐ

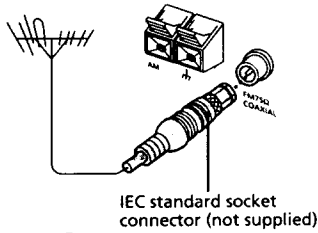

Jack type Ⓑ

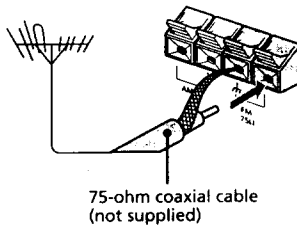

AM antenna

Connect a 6- to 15-meter (20- to 50-feet) insulated wire to the AM antenna terminal. Leave the supplied AM loop antenna connected.

Jack type Ⓐ

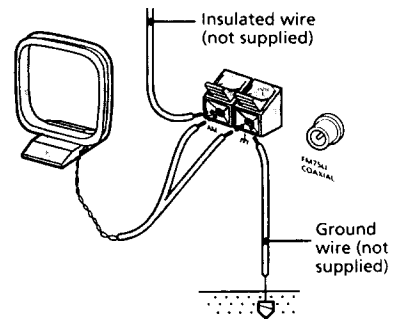

Jack type Ⓑ

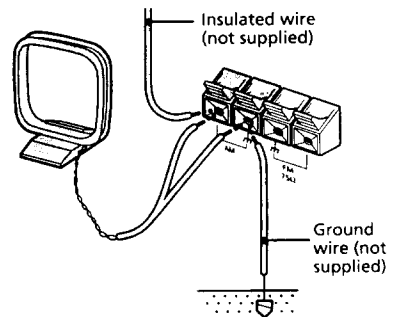

Important

If you connect an outdoor antenna, ground it against lightning. To prevent a gas explosion, do not connect the ground wire to a gas pipe.

Additional Information

Precautions

On operating voltage

Before operating the system, check that the operating voltage of your system is identical with the voltage of your local power supply.

On safety

- The system is not disconnected from the AC power source (mains) as long as it is connected to the wall outlet, even if the system itself has been turned off.
- Unplug the system from the wall outlet (mains) if it is not to be used for an extended period of time. To disconnect the cord (mains lead), pull it out by the plug. Never pull the cord itself.
- Should any solid object or liquid fall into the system, unplug the system and have it checked by qualified personnel before operating it any further.
- The AC power cord must be changed only at a qualified service shop.

On placement

- Place the system in a location with adequate ventilation to prevent heat build-up in the system.
- Do not place the system in an inclined position.
- Do not place the system in locations where it is:
 - Extremely hot or cold
 - Dusty or dirty
 - Very humid
 - Vibrating
 - Subject to direct sunlight.
- To ensure that heat produced by the system is effectively dissipated, provide sufficient space to the rear and do not place anything on top of the system.

On operation

If the system is brought directly from a cold to a warm location, or is placed in a very damp room, moisture may condense on the lens inside the CD player or the MD deck. Should this occur, the system will not operate properly. Remove any CDs or MDs and leave the system turned on for about an hour until the moisture evaporates.

On transportation

- Make sure you remove all discs, and turn off the system. If you move the system with the discs inserted, you may be unable to remove the discs.
- Before you move the system, turn off the system and make sure all operations have finished. Then insert the transport cartridge to the MD 4 slot of the MD deck with the arrow side up and the arrow pointing toward the deck. Firmly insert and bend the paper attached to the cartridge, then close the door of the MD deck. Do not move the MD deck without inserting the transport cartridge, as this may cause deck trouble.

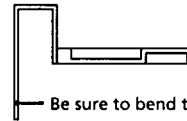

If you have any questions or problems concerning your system, please consult your nearest Sony dealer.

On the speaker system

Although this speaker system is magnetically shielded, there may be cases where the picture on some TV sets becomes magnetically distorted. In such a case, turn off the power of the TV set/ personal computer set once, and after 15 to 30 minutes turn it on again.

When there seems to be no improvement, locate the speaker system further away from the TV set. Furthermore, be sure not to place objects in which magnets are attached or used near the speaker system, such as audio racks, TV stands, toys etc. These may cause magnetic distortion to the picture due to their interaction with the system.

Notes on MDs

- Do not open the shutter to expose the MD. Close the shutter immediately if the shutter opens.
- If you try to force the shutter open, the disc may be damaged. If the shutter opens, close it immediately without touching the disc inside.
- Affix the label supplied with the disc only to the specified label indentation. Do not affix the label around the shutter or in other locations. Note that the shape of the indentation depends on the disc.

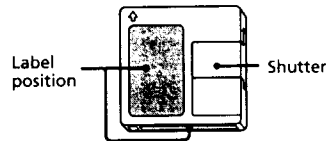

- Do not affix labels or seals to the shutter. The shutter may be unable to open, resulting in mechanical trouble.
- Wipe the disc cartridge with a dry cloth to remove dirt.
- Do not expose the MD to direct sunlight or heat sources such as hot air ducts, nor leave it in a car parked in direct sunlight.

Notes on CDs

- Do not use any CD with tape, seals, or paste on it as this may damage the player.
- Before playing, clean the CD with a cleaning cloth. Wipe the CD from the center out.
- Do not use solvents such as benzene, thinner, commercially available cleaners, or antistatic spray intended for vinyl LPs.
- Do not expose the CD to direct sunlight or heat sources such as hot air ducts, nor leave it in a car parked in direct sunlight.

Cleaning the cabinet

- Use a soft cloth slightly moistened with mild detergent solution. Do not use solvents such as benzene, thinner or alcohol as these may damage the surface.

System limitations of MDs

The recording system in your MD deck has the limitations described below. Note, however, that these limitations are due to the inherent nature of the MD recording system itself and not to mechanical causes.

"Disc Full" appears before the MD has reached the maximum recording time (60 or 74 minutes)

When 255 tracks have been recorded on the MD, "Disc Full" appears regardless of the total recorded time. More than 255 tracks cannot be recorded on the MD. To continue recording, erase unnecessary tracks or use another recordable MD.

"Disc Full" appears before the maximum number of tracks (255) is reached

Fluctuations in emphasis within tracks are sometimes interpreted as track intervals, increasing the track count and causing "Disc Full" to appear.

The remaining recording time does not increase even after erasing numerous short tracks

Tracks shorter than 12 seconds long are not counted, so erasing them may not increase the recording time.

Some tracks cannot be combined with others

Track combination may become impossible when tracks are shorter than 12 seconds long.

The total recorded time and the remaining time on the MD do not reach the maximum recording time (60 or 74 minutes)

Recording is done in minimum units of 2 seconds each, no matter how short the material. The contents recorded may thus be shorter than the maximum recording capacity. Disc space may also be further reduced by scratches.

System limitations of MDs (continued)

The sound may drop-out while searching the edited tracks

Tracks created through editing may exhibit sound dropout during searching because high-speed playback takes time to search for the position on the disc when the tracks are scattered on the disc.

Track numbers cannot be marked

During Level Synchro Recording, the track numbers may not be marked at the beginning of the track:

- if the input signal is below a certain fixed level for less than two seconds between tracks.
- if the input signal is below a certain fixed level for more than two seconds in the middle of the track.

Guide to the Serial Copy Management System

Digital audio components, such as CDs, MDs, and DATs let you copy music easily with high quality, for these digital products process music as a digital signal.

To protect the copyrighted music programs, this system uses the Serial Copy Management System which allows you to make only a single copy of a recorded digital source through digital-to-digital connections.

You can make only a first generation copy* through a digital-to-digital connection.

That is:

- 1** You can make a copy of a commercially available digital sound program (e.g., a CD or an MD), but you cannot make a second copy from the first-generation copy.
 - 2** You can make a copy of a digital signal from a digitally recorded analog sound program (e.g., an analog record or a music cassette tape) or from a digital satellite broadcast program, but you cannot make a second copy.
- * A first-generation copy means a digital recording of a digital signal made on digital audio equipment. For example, if you record from this system's CD player to this MD deck, you would make a first-generation copy.

Notes

- This copy management system does not apply when you make a recording through analog-to-analog connections.
- This system's MD deck supports the 32 kHz or 48 kHz sampling frequency of the DAT deck or digital satellite broadcast programs as well as the 44.1 kHz sampling rate of the MD deck. You can make a second copy from a digital recording of a satellite broadcast program.

Troubleshooting

If you run into any problem using this stereo system, check it according to the procedure described below.

A 3-digit code and a message are flashing alternately in the display

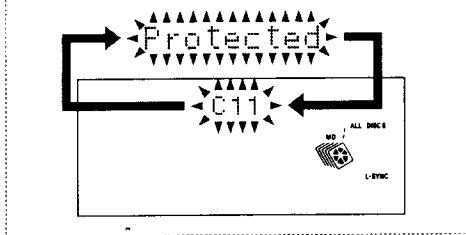

Yes



Refer to the Self-diagnosis display function (page 93)

No ↓

A message appears in the display

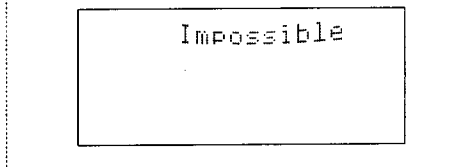

Yes



Refer to Display* messages (page 94)

No ↓

Refer to the tables below and check the system again. Should any problem persist, consult your nearest Sony dealer.

General

Symptom	Cause and countermeasure
There is no sound.	The volume is too low. → Turn VOLUME clockwise.
	The headphones are connected. → Unplug the headphones.
	The speakers are not connected properly. → Connect the speaker cords properly (see page 5).

Troubleshooting (continued)

Symptom	Cause and countermeasure
Sound comes from one channel or unbalanced left and right volume.	<ul style="list-style-type: none"> • The speaker cords are not connected properly (+/-). • The vinyl portion of the speaker cords is inserted into the SPEAKER terminals.
	→ Connect the speaker cords properly (see page 5).
	The speaker placement (left/right) is reversed.
	→ Place the speakers properly (see page 5).
There is severe hum or noise.	The heights and distances of the left and right speakers differ greatly.
	→ Place the speakers as symmetrically as possible.
	Two or more speakers are connected to the same SPEAKER terminals.
	→ Connect only one of the supplied speakers to each set of SPEAKER terminals.
"0:00" (for the European model) or "0:00AM" (for other models) flashes in the display.	The connected speakers are not the supplied ones.
	→ Connect the supplied speakers.
	A TV, VCR or other source of noise is placed too close to the system.
	→ Move the system away from the source of noise.
The timer cannot be set.	A refrigerator or other source of noise is connected to the same wall outlet.
	→ Connect the system to a different wall outlet.
	→ Install a noise filter (commercially available) to the power line.
	The power cord was unplugged or a power interruption occurred, erasing the clock setting.
The timer does not function.	→ Set the clock again (see page 8).
	• The clock is not set.
	• A power interruption occurred, erasing the clock setting.
	→ Set the clock again (see page 8).
The remote does not function.	The timer was not set correctly before you turned off the system.
	→ Press TIMER SELECT to set the timer and light up "DAILY" or "REC 1 - 5" in the display (see pages 65 and 67).
	The set time is incorrect.
	→ Check the set contents and set the correct time (see pages 64 - 68).
The remote does not function.	The TAPE CONTROL system cable of the optional TC-PX100 tape deck is not connected.
	→ Connect the TAPE CONTROL system cable properly (see page 78).
	The timer of the connected optional component is not set.
	→ Refer to the operating instructions included with the connected component and set the timer to the same time as the system's timer.
The remote does not function.	There is an obstacle between the remote and the system.
	→ Remove the obstacle.
	The remote is too far from the system.
	→ Move the remote closer to the system.

Symptom	Cause and countermeasure
The remote does not function.	The remote is not pointing in the direction of the system's sensor. → Point the remote at the system's sensor.
	The remote's batteries have run down. → Replace the batteries (R6/size AA).
	The system is near an inverter type fluorescent light. → Locate the system away from the fluorescent light.

CD

Symptom	Cause and countermeasure
The disc tray does not close.	The disc is not placed in the center of the tray. → Place the disc properly in the center of the tray.
	You tried to forcibly press the disc tray closed. → Always close the tray by pressing CD 1 - 5 ▲. Trying to press the tray closed with your fingers may cause CD player trouble.
The disc does not eject.	The system was moved or shaken with a disc loaded, and the disc has become lodged inside the CD player. → Consult your nearest Sony dealer.
Play does not start.	There is no disc in the CD player. → Open the disc tray and check whether a disc is loaded.
	The disc is dirty (e.g., oil film, fingerprints). → Wipe the disc clean (see page 83).
	The disc is scratched. → Replace the disc.
	The disc you tried to play is a non-standard size or shape, or uses a non-standard recording method. → Replace the disc.
	The disc is off-center. → Place the disc properly in the center of the tray.
	The CD is inserted with the label side down. → Place the CD in the tray with the label side up.
	Moisture condensation has built up on the lens inside the CD player or on the disc. → Remove the disc and wipe away the moisture on the disc, then leave the system turned on for a few hours until the moisture evaporates.
The CD player is not set to play mode. → Press ▷ for the CD to start play.	
The sound skips.	The disc is dirty (e.g., oil film, fingerprints). → Wipe the disc clean (see page 83).
	The disc is scratched. → Replace the disc.

Troubleshooting (continued)

Symptom	Cause and countermeasure
The sound skips.	<p>The disc you tried to play is a non-standard size or shape, or uses a non-standard recording method.</p> <p>→ Replace the disc.</p> <p>The system is subject to vibration.</p> <p>→ Try moving the system to a place without vibration (e.g., on top of a stable stand).</p> <p>→ Try moving the speakers away from the system, or placing them on separate stands.</p> <p>When you listen to a track with bass sounds at high volume, the speaker vibration may cause the sound to skip.</p>
Play does not start from the first track.	<p>The CD player is in Program or Shuffle Play mode.</p> <p>→ Press PLAY MODE repeatedly until "PROGRAM" or "SHUFFLE" disappears to return to normal play.</p>
"—OVER—" is displayed.	<p>You have reached the end of the disc while pressing ►►.</p> <p>→ Keep pressing ◀◀ or turn MULTI JOG to return to the desired playing position.</p>
A CD button lights even though there is no CD loaded.	<p>The first time that you turn the system on after purchase, the buttons light for a short moment, and then turn off.</p> <p>The last time that you used the unit, you pressed I/⏻ (power) and turned the system off while the CD tray was open.</p> <p>→ If you wait for a moment, the light will turn off. If not, press CD 1 - 5 ▲ to open and close the trays.</p>

Tuner (Radio)

Symptom	Cause and countermeasure
Severe hum or noise/stations cannot be received.	<p>The broadcast station band (FM and AM for the North American model, FM, MW and LW for the European model, FM, MW and SW for other models) or frequency are not correct.</p> <p>→ Set the proper band and frequency (see page 10).</p> <p>The antenna is not connected properly.</p> <p>→ Connect the antenna properly (see pages 6 and 7).</p> <ul style="list-style-type: none"> • The antenna is set up in a place with poor reception. • The signal strength is too weak. <p>→ Find a place and an orientation that provide good reception, then set up the antenna again.</p> <p>If you cannot obtain good reception, we recommend you connect a commercially available outdoor antenna.</p>

Symptom	Cause and countermeasure
Severe hum or noise/stations cannot be received.	Part of the antenna is folded, tied or rolled up. → The supplied FM lead antenna receives signals along its entire length, so make sure you extend it fully (see pages 6 and 7).
	Part of the antenna is tied together with the speaker cord. → Locate the antennas as far away from the speaker cords as possible.
	The supplied AM antenna has come off the plastic stand. → Consult your nearest Sony dealer.
	The system is affected by electrical equipment. → Try turning off the electrical equipment.
A stereo FM program cannot be received in stereo.	The tuner is set to MONO. → Press STEREO/MONO until "STEREO" appears in the display.
	Reception is poor. → See "Severe hum or noise/stations cannot be received." under "Troubleshooting" on pages 88 and 89, and check the antenna condition.
Cyclical static noise is heard while recording on an MD.	The antenna is not oriented correctly. → Adjust the antenna orientation and position until the noise stops.

MD

Symptom	Cause and countermeasure
A disc cannot be inserted.	The disc is upside-down or facing the wrong direction. → Insert the disc with the arrow side up and the arrow pointing toward the deck.
The controls do not work.	The MD is dirty or damaged. → Replace the MD with a new one.
Play does not start.	The disc is dirty (e.g., oil film, fingerprints) or scratched. → Replace the disc
	Nothing is recorded on the disc. → Replace the disc with a recorded one.
	Moisture condensation has built up on the lens inside the MD deck or on the disc. → Insert the disc and leave the system turned on for a few hours until the moisture evaporates.
	The MD deck is not set to play mode. → Press ▷ for the MD to start play.
The sound skips.	The disc is dirty (e.g., oil film, fingerprints) or scratched. → Replace the disc.

Troubleshooting (continued)

Symptom	Cause and countermeasure
The sound skips.	<p>The system is subject to vibration.</p> <ul style="list-style-type: none"> → Try moving the system to a place without vibration (e.g., on top of a stable stand). → Try moving the speakers away from the system, or placing them on separate stands. <p>When you listen to a track with bass sounds at high volume, the speaker vibration may cause the sound to skip.</p> <hr/> <p>The inside of the system and the disc are different temperatures.</p> <ul style="list-style-type: none"> → Insert the disc and wait for 10 to 20 minutes with the system turned on.
Play does not start from the first track.	<p>The MD deck is in Program or Shuffle Play mode.</p> <ul style="list-style-type: none"> → Press PLAY MODE repeatedly until "PROGRAM" or "SHUFFLE" disappears to return to normal play.
Recording or editing was done, but the TOC is not updated.	<p>You pulled out the power cord without ejecting the MD after recording or editing an MD.</p> <ul style="list-style-type: none"> → MD recording and editing contents are written to the MD when the MD is ejected, so make sure you eject the MD after recording or editing (see pages 35 and 50).
Play does not finish even when Repeat Play is not selected. Or the MD deck goes back to the first track during Shuffle or Program Play.	<p>The MD could not be read properly, or it is not inserted completely.</p> <ul style="list-style-type: none"> → Remove the MD and then reinsert it to the correct position (until it stops).
Recording is not possible.	<p>The MD is protected against erasure ("C11" and "Protected" appear alternately).</p> <ul style="list-style-type: none"> → Eject the disc and slide the tab closed to cover the hole (see page 35). <hr/> <p>The optional A/V component is not connected properly.</p> <ul style="list-style-type: none"> → Connect the optional A/V component properly (see page 75, 78 and 79). <hr/> <p>The sound source is set to MD.</p> <ul style="list-style-type: none"> → Switch to another sound source. <hr/> <p>A premastered MD is inserted in the deck.</p> <ul style="list-style-type: none"> → Replace the MD with a recordable MD. <hr/> <p>There is no time remaining on the MD.</p> <ul style="list-style-type: none"> → Replace the disc with a recordable MD, or use the Erase Function to erase unnecessary tracks (see pages 53 – 56). <hr/> <p>The CD disc tray is open.</p> <ul style="list-style-type: none"> → Press  to close the tray. <hr/> <p>The power cord was unplugged or a power interruption occurred during recording.</p> <ul style="list-style-type: none"> → Start recording over from the beginning.

Symptom	Cause and countermeasure
The sound from an MD you recorded is too low (or too high).	The recording level is set too low (or too high). → Readjust the recording level (see page 48).
You cannot edit.	The MD is not loaded (to the recording/playing unit). → Press ▲ to load the MD you want to edit.

Optional components

Symptom	Cause and countermeasure
There is no sound.	The system is not set properly. → Refer to General item "There is no sound." under "Troubleshooting" on page 85 and check the condition of the system.
	The optional A/V component is not connected properly. → Connect the component properly (see pages 75, 78 and 79) while checking: <ul style="list-style-type: none"> • if the cords/cables are connected properly. • if the cord/cable connectors are firmly inserted all the way.
	The connected component is not turned on. → Turn on the connected component.
	The connected component has not started playing. → Refer to the operating instructions included with the connected component and start playing.
The sound from the DVD player is too loud or distorted.	FUNCTION is set to "VIDEO". → Set FUNCTION to "DVD". (If "VIDEO" is selected for FUNCTION, press MENU/NO and then press ENTER/YES to switch to "DVD". The maximum level of the signals output by a DVD player is different from that of other analog components, always be certain to switch to "DVD" when listening to sound from a DVD player. If FUNCTION is not set properly, the system may malfunction.)
The sound from the VCR is at a low volume.	FUNCTION is set to "DVD". → Set FUNCTION to "VIDEO". (If "DVD" is selected for FUNCTION, press MENU/NO and then press ENTER/YES to switch to "VIDEO". The maximum level of the signals output by a DVD player are different from that of other analog components, always be certain to switch to "VIDEO" when changing a connected component from a DVD player to a VCR or other such component. If FUNCTION is not set properly, the system may malfunction.)

Troubleshooting (continued)

Symptom	Cause and countermeasure
The volume from the MD WALKMAN is low.	The input level of the selected function is low. → Adjust the input level (see page 77).
The sound from the MD WALKMAN drops out/is distorted, or noise occurs.	The MD WALKMAN is not set correctly, or is positioned incorrectly. → Set the Mega Bass function, AVLS function and volume of the MD WALKMAN (see page 75). → Remove the MD WALKMAN from on top of the system and place it so that it does not touch the system.

If the system still does not operate properly after performing the above measures, reset the system as follows:

- 1 With the system turned on, press NAME EDIT/CHARACTER, 1/ALL and UPPER DISPLAY at the same time.
- 2 Press I/⏻ (power).
"RESET OK!" appears, and the system turns off.
- 3 Unplug the power cord.
- 4 Plug the power cord back into the wall outlet.

The system is reset to the factory settings. All the settings you made such as the preset stations, clock, timer and CD disc titles are cleared and must be set again.

Self-diagnosis display function

(If a 3-digit code and a message appear alternately)

This system has a Self-diagnosis display function that alternately displays a 3-digit code and a message to inform you when it is not operating properly. Check the display, then perform the measures in the table below to remedy the problem. Should any problem persist even after two or three times, consult your nearest Sony dealer.

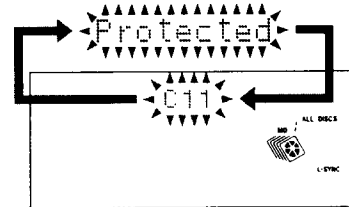

Code/Message	Cause and countermeasure
C11/Protected	The inserted disc is protected against erasure. → Eject the disc, then slide the tab closed to cover the hole (see page 35).
C12/Cannot Copy	You are attempting to play a CD or MD with a format that the system does not support, such as a CD-ROM or MD data. → Insert a CD or MD that is playable.
C13/REC Error	Recording could not be performed properly. → Move the system to a place without vibration, then start recording over from the beginning (see the MD item "The sound skips." under "Troubleshooting" on pages 89 and 90). The disc is dirty (e.g., oil film, fingerprints) or scratched, or a non-standard disc is inserted in the deck. → Replace the disc, then start recording over from the beginning.
C13/Read Error	The disc could not be read properly. → Eject the disc, then insert it again.
C14/Toc Error	The disc could not be read properly. → Insert a different disc. → If the entire contents of the disc may be erased, use the All Erase Function to erase all the recorded contents (see page 54).
C41/Cannot Copy	The sound source is a copy of a commercially available music software. → The Serial Copy Management System prevents you from making a digital copy (see page 84).

Display messages

One of the following messages may appear or flash in the display during operation.

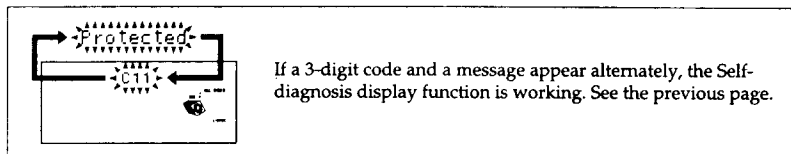

MD

Message	Cause and countermeasure
Auto Cut	Silence continued for 30 seconds or more during digital recording, so the Auto Cut function activated to replace the silence with a blank of about 3 seconds and pause the recording. → Press ▷ for the MD to restart the recording at the desired point. If you do not want to shorten the space between tracks, turn off the Smart Space function (see page 44), then start recording over from the beginning.
Blank Disc	The inserted recordable MD is brand new or all tracks on the MD have been erased using the Erase Function. → —
Cannot Edit	A commercially available premastered MD is inserted in the deck. → You cannot edit a premastered MD. The deck is in Program or Shuffle Play mode. → Press PLAY MODE repeatedly until "PROGRAM" or "SHUFFLE" disappears to return to normal play.
Cannot REC	A commercially available premastered MD is inserted in the deck. → You cannot record on a premastered MD. You tried to record on an MD with FUNCTION set to MD. → Press FUNCTION to select the sound source you want to record.
Complete!!	MD editing finished normally. → —
Disc Full	There is no time remaining on the disc. → Replace the disc with a new one.
Impossible	You tried to do an impossible MD editing operation. → Start editing over from the beginning (see pages 56, 59 and 60). You cannot combine the tracks due to the system limitations of MDs. → Editing cannot be done as specified. MDs do not record a track continuously, but instead record the data efficiently while searching for empty space on the disc. This lets you record and edit an MD repeatedly. However, when you repeatedly record and edit an MD, the track is recorded bit by bit scattered over the disc. These scattered tracks cannot be combined with other tracks due to the system limitations of MDs.

Message	Cause and countermeasure
MD PULL DISC	There is already an MD loaded in the MD recording/playing unit, but there are 5 MDs in the slots so the loaded MD cannot be removed. → Remove an MD from a slot.
MD RE-INSERT!	The transport cartridge is still inserted. → Turn off the system and wait for the mechanism to come to a complete stop, then remove the cartridge. The MD was inserted in the slot in the wrong direction. → Turn off the system and wait for the mechanism to come to a complete stop, then remove the MD. The MD is not inserted completely. → Remove the MD and then reinsert it to the correct position (until it stops). The MD is not inserted to the correct position. → Reinsert the MD. If the MD deck still does not operate, turn the system off and then on again. After you press the power button, the MD is ejected to the slot and the system turns off. If the MD is not ejected to the slot, consult your nearest Sony dealer.
Name Full !!	There is no more space to store disc or track titles (you have already input 1,700 characters). → Erase unnecessary track titles, then input the title again.
New Track	You specified recording on a brand new MD or after the recorded tracks (e.g. previously unrecorded space). → —
No Disc	There is no disc in the MD deck. → —
No Name	You tried to show the title of a non-labeled disc or track. → You can assign disc and track titles to a recordable MD (see page 52).
No Track	The inserted disc has a disc title but no tracks. → —
—OVER—	You have reached the end of the disc while pressing ►► during playing pause. → Keep pressing ◀◀ or turn MULTI JOG to return to the desired playing position.
Premastered	You tried to record on a premastered MD. → —
Program Clear!	You inserted a disc into a slot containing an MD included in a program you made (whose MD 1 – 5 button lights green), so the entire program was cleared. → Make the program again.
Push STOP !	You pressed PLAY MODE while an MD is playing. → You cannot change the play mode during play. Press ■ for the MD to stop play, then press PLAY MODE.
—Rehearsal—	The portion to be divided by the Divide Function is being played for confirmation. → Listen to the played contents to confirm the position to be divided (see page 58).
Release	The system is ejecting the disc. → —

Display messages (continued)

Message	Cause and countermeasure
Smart Space	Silence continued for 3 or more but less than 30 seconds during digital recording, so the Smart Space function activated to replace the silence with a blank of about 3 seconds. → If you do not want to shorten the space between tracks, turn off the Smart Space function (see page 44).
Text Protect	There is information in the CD text that cannot be recorded on an MD. → Press NAME EDIT/CHARACTER and then ENTER/YES to record the title of the current track.
TOC Reading	The deck is reading the MD Table of Contents (TOC). → Wait until "TOC Reading" disappears. Do not move the deck until "TOC Reading" disappears to ensure proper reading.
TOC writing	The MD Table of Contents (TOC) is being updated. → Wait until "TOC writing" disappears. Do not move the deck until "TOC writing" disappears to ensure the complete recording or editing.
Track End	You have reached the end of the disc while adjusting the position to be divided by the Divide Function. → Change the position (see page 58).

Tuner (Radio)

Message	Cause and countermeasure
OFF TIME NG!	You have set the start time and the end time for timer recording to the same time. → Reset the times so that they are different. (pages 64 and 67)

CD

Message	Cause and countermeasure
Check and CD 1 (or 2 - 5) Position appear alternately	The disc could not be read properly. → Insert the disc whose number is displayed again.
Complete!!	CD editing (Disc Memo) finished normally. → —
File Full	There is no more space to store disc titles (you have already input 100 disc titles). → Erase unnecessary disc titles, then input the disc title again (see page 31).
No Disc	There is no disc in the CD player. → —
—OVER—	You have reached the end of the disc while pressing ►►. → Keep pressing ◀◀ or turn MULTI JOG to return to the desired playing position.

Specifications

Main Unit (HCD-MD555)

Amplifier section

For the U.S. model

AUDIO POWER SPECIFICATIONS

POWER OUTPUT AND TOTAL HARMONIC DISTORTION:
With 6 ohm loads, both channels driven, from 70 - 20,000 Hz; rated 25 watts per channel minimum RMS power, with no more than 0.9% total harmonic distortion from 250 milliwatts to rated output.

European model:

DIN power output (Rated) 30 + 30 watts (6 ohms at 1 kHz, DIN, 230 V)
Continuous RMS power output (Reference) 40 + 40 watts (6 ohms at 1 kHz, 10% THD)
Music power output (Reference) 60 + 60 watts

Other models:

DIN power output (Rated) 30 + 30 watts (6 ohms at 1 kHz, DIN, 120/240 V)
Continuous RMS power output (Reference) 40 + 40 watts (6 ohms at 1 kHz, 10% THD)
Peak music power output (Reference) 700 watts

Inputs

DVD/VIDEO IN (phono jacks) (switchable)
DVD IN: voltage 450 mV, impedance 47 kilohms
VIDEO IN: voltage 250 mV, impedance 47 kilohms
TAPE IN (phono jacks): voltage 250 mV, impedance 47 kilohms
MD WALKMAN LINK IN (stereo mini jack): voltage 125 mV, impedance 15 ohms

Outputs

TAPE OUT (phono jacks): voltage 250 mV, impedance 1 kilohm
PHONES (stereo mini jack): accepts headphones of 8 ohms or more.
SPEAKER: accepts impedance of 6 to 16 ohms.

CD player section

System Compact disc and digital audio system
Laser Semiconductor laser ($\lambda = 780 \text{ nm}$)
Emission duration: continuous
Laser output Max. 44.6 μW^*
* This output is the value measured at a distance of 200 mm from the objective lens surface on the Optical Pick-up Block with 7 mm aperture.
Frequency response 2 Hz to 20 kHz

MD deck section

System MiniDisc digital audio system
Laser Semiconductor laser ($\lambda = 780 \text{ nm}$)
Emission duration: continuous
Laser output Max. 44.6 μW^*
* This output is the value measured at a distance of 200 mm from the objective lens surface on the Optical Pick-up Block with 7 mm aperture.
Recording time 74 minutes max. (using MDW-74)
Sampling frequency 44.1 kHz
Frequency response 5 Hz to 20 kHz

Additional Information

Specifications (continued)

Tuner section

FM stereo, FM/AM superheterodyne tuner

FM tuner section

Tuning range 87.5 – 108.0 MHz
(50 kHz step)
Antenna FM lead antenna
Antenna terminals 75 ohms unbalanced
Intermediate frequency 10.7 MHz

AM tuner section

Tuning range
North American model:
AM: 530 – 1,710 kHz
(with the interval set at
10 kHz)
531 – 1,710 kHz
(with the interval set at
9 kHz)
European model:
MW: 531 – 1,602 kHz
(with the interval set at
9 kHz)
LW: 153 – 279 kHz
(with the interval set at
3 kHz)
Other models:
MW: 531 – 1,602 kHz
(with the interval set at
9 kHz)
530 – 1,710 kHz
(with the interval set at
10 kHz)
SW: 5.95 – 17.90 MHz
Antenna AM loop antenna
Antenna terminals External antenna
Intermediate frequency 450 kHz

Speaker (SS-MD555)

Speaker system 2-way, bass-reflex type
Speaker units
Woofers: 15 cm (6 in.) dia., cone
type
Tweeters: 2.5 cm (1 in.) dia., balance
drive type
Nominal impedance 6 ohms

General

Power requirements
North American model: 120 V AC, 60 Hz
European model: 220 – 230 V AC, 50/60 Hz
Other models: 110 – 120 V or 220 – 240 V
AC, 50/60 Hz (adjustable
with the voltage selector)
Power consumption 90 watts during normal
operation
3 watts* or less in standby
mode (clock displayed)
Approximately 1 watt* in
standby mode (clock not
displayed)
* Value measured at 110
or 220 V (except for North
American and European
models).

Dimensions (w/h/d) incl. projecting parts and
controls

Amplifier/Tuner/MD/CD section:

Approx. 215 x 320 x
410 mm (8 ¹/₂ x 12 ³/₈ x
16 ¹/₄ in.)

Speakers:

Approx. 195 x 320 x
270 mm (7 ³/₄ x 12 ⁵/₈ x
10 ³/₄ in.)

Mass

Amplifier/Tuner/MD/CD section:

Approx. 9.5 kg (20 lbs
15 oz.)

Speakers:

Approx. 3.6 kg (7 lb
15 oz.) net per speaker

Supplied accessories:

Remote RM-MD555 (1)
R6 (size AA) batteries (2)
Transport cartridge (1)
FM lead antenna (1)
AM loop antenna (1)
Speaker cords (2)
MD WALKMAN LINK
cable (1)
Plug adapter (except for
North American and
European models) (1)

Design and specifications are subject to change
without notice.

Index

A

- Adjusting
 - the operating voltage 7
 - the recording level 48
 - the sound 62
 - the volume 15, 20, 22
- All Erase Function 54
- Analog recording 35
- Antennas 6, 81
- Audio cords 78
- Auto Cut 44
- Automatic Source Selection 15, 20, 22
- Automatic tuning 22, 24

B

- Batteries 8
- Before
 - editing 50
 - recording 35

C

- CD Synchro Recording 36
- CD text information 34
- Checking the remaining time 30
- Clock setting 8
- Combine Function 59
- Connecting *See* Hooking up

D

- Daily Timer 64
- DBFB (Dynamic Bass Feedback) 62
- Disc Memo 31
- Disc Memo Copy 17, 31, 39, 51
- Display 30
- Divide Function 58

E

- Erase Function 53
- Erasing
 - a portion of a track (A-B Erase) 55
 - a single track (Tr Erase) 53
 - all tracks on an MD (All Erase) 54

F

- Features of the DHC-MD555 12

G

- GROOVE (powerful sound) 62

H, I, J, K

- Hit parade 41
- Hooking up
 - an MD WALKMAN 75
 - A/V components 78
 - the antennas 6, 81
 - the power 7
 - the speakers 5
 - the system 4
 - the TC-PX100 tape deck 78

L

- Labeling
 - a CD (Disc Memo) 31
 - an MD (Name Function) 51
 - a preset station 69
- Level Synchro Recording 46
- Listening to the radio 21

M

- Manual tuning 22, 24
- Messages 94
- Move Function 57

N

- Name Function 51
- Normal Play 14, 18

O

- Optional equipment 74

P

- Playing
 - a CD 14
 - an MD 18
 - A/V components 78
 - tracks in random order (Shuffle Play) 25
 - tracks in the desired order (Program Play) 26
 - tracks repeatedly (Repeat Play) 29
- Power Saving Mode 9
- Precautions 82
- Preset equalizer 62
- Preset tuning 21
- Presetting radio stations 10
- Program Play 26
- Protecting recordings 35
- PTY 71

Q

- Quick Changer 29

Index (continued)

R

Radio stations
 presetting 10
 tuning in 21
RDS (Radio Data System) 71
Recording
 a CD 16, 37
 a radio program 23
 from an MD
 WALKMAN 76
 from A/V
 components 80
 level synchro
 recording 46
 manual recording 23, 43
 monaural recording 49
 on an MD 16, 23, 35
 timer recording 66
 types 36
 with prestored data 45
Rec It 42
Repeat Play 29
Resetting the system 92

S

Saving recordings 35
Seamless Recording 39
Select Synchro
 Recording 16, 37
Self-diagnosis display
 function 93
Serial copy management
 system 84
Setting the time 8
Showing the time 9
Shuffle Play 25
Sleep Timer 63
Smart Space 44
Sound adjustment 62
Speakers 5
Station Name 69
System limitations of
 MDs 83

T

Time Machine Recording 45
Timer
 falling asleep to music
 (Sleep Timer) 63
 timer recording 66
 waking up to music
 (Daily Timer) 64
TOC 18, 25, 35, 39 ~ 43, 46,
 50, 77, 80
Track marking 46
Track numbers 46
Transport cartridge 5, 82
Tr Erase Function 53
Troubleshooting 85
Tuning interval 11

U, V, W, X, Y, Z

Undo Function 61

Sony online <http://www.world.sony.com/>
