

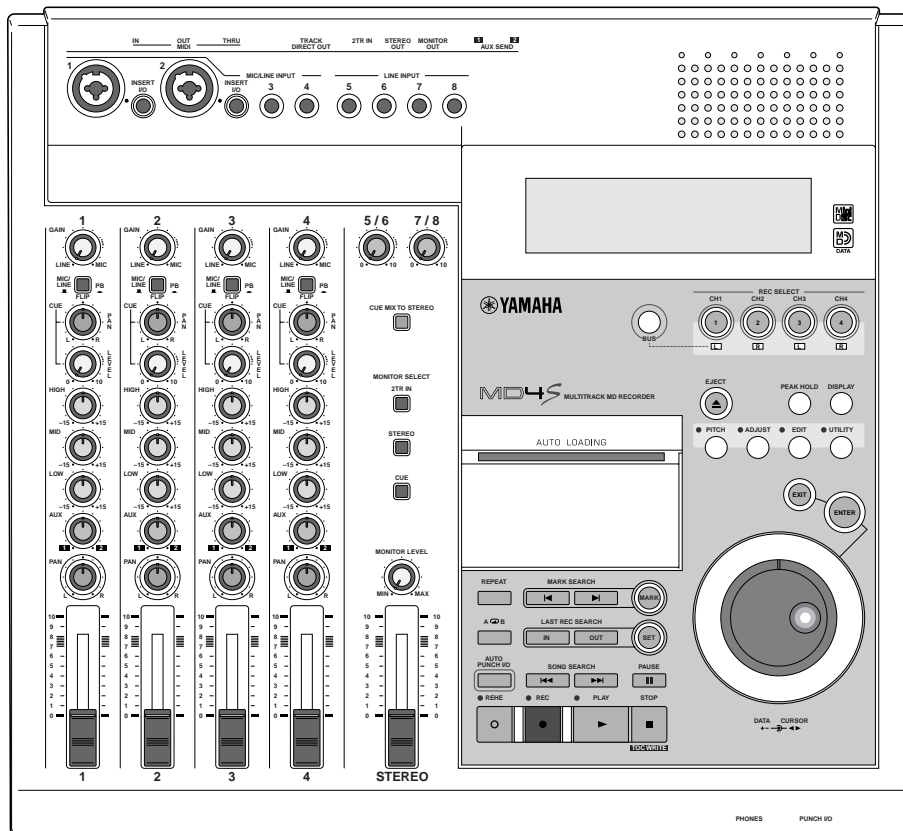

MULTITRACK MD RECORDER

MD4S

Owner's Manual



FCC INFORMATION (U.S.A.)

1. **IMPORTANT NOTICE: DO NOT MODIFY THIS UNIT!** This product, when installed as indicated in the instructions contained in this manual, meets FCC requirements. Modifications not expressly approved by Yamaha may void your authority, granted by the FCC, to use the product.
2. **IMPORTANT:** When connecting this product to accessories and/or another product use only high quality shielded cables. Cable/s supplied with this product **MUST** be used. Follow all installation instructions. Failure to follow instructions could void your FCC authorization to use this product in the USA.
3. **NOTE:** This product has been tested and found to comply with the requirements listed in FCC Regulations, Part 15 for Class "B" digital devices. Compliance with these requirements provides a reasonable level of assurance that your use of this product in a residential environment will not result in harmful interference with other electronic devices. This equipment generates/uses radio frequencies and, if not installed and used according to the instructions found in the users manual, may cause interference harmful to the operation of other electronic devices. Compliance with FCC regulations does not guarantee that interference will not occur in all installations. If this product is found to be the source of interference, which can be determined by turning the unit "OFF" and "ON", please try to eliminate the problem by using one of the following measures: Relocate either this product or the device that is being affected by the interference. Utilize power outlets that are on different branch (circuit breaker or fuse) circuits or install AC line filter/s. In the case of radio or TV interference, relocate/reorient the antenna. If the antenna lead-in is 300 ohm ribbon lead, change the lead-in to coaxial type cable. If these corrective measures do not produce satisfactory results, please contact the local retailer authorized to distribute this type of product. If you can not locate the appropriate retailer, please contact Yamaha Corporation of America, Electronic Service Division, 6600 Orangethorpe Ave, Buena Park, CA 90620

The above statements apply **ONLY** to those products distributed by Yamaha Corporation of America or its subsidiaries.

IMPORTANT

Please record the serial number of this unit in the space below.

Serial No.:

The serial number is located on the bottom or rear of the unit.
Retain this Owner's Manual in a safe place for future reference.

IMPORTANT

THE WIRES IN MAINS LEAD ARE COLOURED IN ACCORDANCE WITH THE FOLLOWING CODE:

BLUE : NEUTRAL
BROWN : LIVE

As the colours of the wires in the mains lead of this apparatus may not correspond with the coloured markings identifying the terminals in your plug proceed as follows:

The wire which is coloured BLUE must be connected to the terminal which is marked with the letter N or coloured BLACK.

The wire which is coloured BROWN must be connected to the terminal which is marked with the letter L or coloured RED.

Making sure that neither core is connected to the earth terminal of the three pin plug.

* This applies only to products distributed by YAMAHA KEMBLE MUSIC (U.K.) LTD.

Laser Diode Properties

- * Material : GaAlAs
 - * Wavelength : 780–790 nm
 - * Emission Duration : Continuous
 - * Laser Output Power : Less than 44.6 μ W
- (Note) Laser output is measured at a distance of 20cm from the object lens on the optical pick-up head.

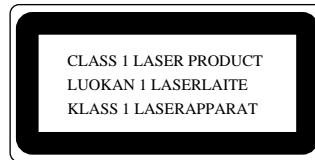

This unit is classified as a Class 1 laser product. This label is located on the exterior.

Klassmärkning för Finland.

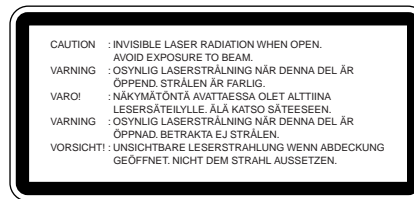

- On USA or Canadian models do not have this label.
- This label is located on the interior.
- Varningsanvisning för laserstrålning. Placerad i apparaten.

CAUTION

USE OF CONTROLS OR ADJUSTMENTS OR PERFORMANCE OF PROCEDURES OTHER THAN THOSE SPECIFIED HEREIN MAY RESULT IN HAZARDOUS RADIATION EXPOSURE.

ADVARSEL

Usynlig laserstrålning ved åbning. Undgå udsættelse for stråling.

VAROITUS

Laitteen käyttäminen muulla kuin tässä käyttöohjeessa mainitulla tavalla saattaa altistaa käyttäjän turvallisuusluokan 1 ylittävälle näkymättömälle lasersäteilylle.

VARNING

Om apparaten används på annat sätt än i denna bruksanvisning specificerats, kan användaren utsättas för osynlig laserstrålning, som överskrider gränsen för laserklass 1.

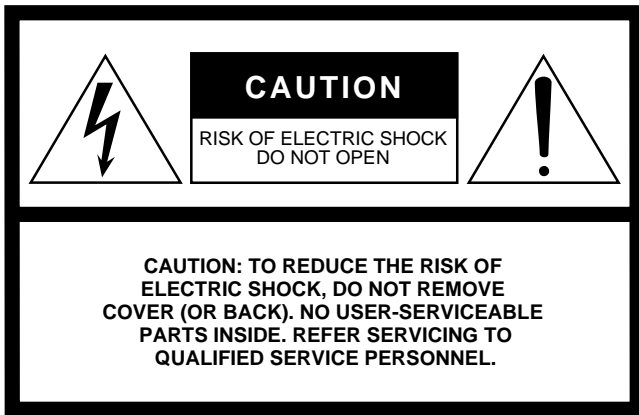

The above warning is located on the bottom or rear of the unit

• Explanation of Graphical Symbols



The exclamation point within an equilateral triangle is intended to alert the user to the presence of important operating and maintenance (servicing) instructions in the literature accompanying the product.

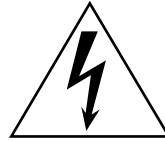

The lightning flash with arrowhead symbol within an equilateral triangle is intended to alert the user to the presence of uninsulated “dangerous voltage” within the product’s enclosure that may be of sufficient magnitude to constitute a risk of electric shock to persons.

SAFETY INSTRUCTIONS

1. Read Instructions — All the safety and operating instructions should be read before the appliance is operated.
2. Retain Instructions — The safety and operating instructions should be retained for future reference.
3. Heed Warnings — All warnings on the appliance and in the operating instructions should be adhered to.
4. Follow Instructions — All operating and use instructions should be followed.
5. Water and Moisture — The appliance should not be used near water – for example, near a bathtub, washbowl, kitchen sink, laundry tub, in a wet basement, or near a swimming pool, and the like.
6. Carts and Stands — The appliance should be used only with a cart or stand that is recommended by the manufacturer.



 - 6A An appliance and cart combination should be moved with care. Quick stops, excessive force, and uneven surfaces may cause the appliance and cart combination to overturn.
7. Wall or Ceiling Mounting — The appliance should be mounted to a wall or ceiling only as recommended by the manufacturer.
8. Ventilation — The appliance should be situated so that its location or position does not interfere with its proper ventilation. For example, the appliance should not be situated on a bed, sofa, rug, or similar surface that may block the ventilation openings; or, placed in a built-in installation, such as a bookcase or cabinet that may impede the flow of air through the ventilation openings.
9. Heat — The appliance should be situated away from heat sources such as radiators, heat registers, stoves, or other appliances (including amplifiers) that produce heat.
10. Power Sources — The appliance should be connected to a power supply only of the type described in the operating instructions or as marked on the appliance.
11. Grounding or Polarization — The precautions that should be taken so that the grounding or polarization means of an appliance is not defeated.
12. Power-Cord Protection — Power-supply cords should be routed so that they are not likely to be walked on or pinched by items placed upon or against them, paying particular attention to cords at plugs, convenience receptacles, and the point where they exit from the appliance.
13. Cleaning — The appliance should be cleaned only as recommended by the manufacturer.
14. Nonuse Periods — The power cord of the appliance should be unplugged from the outlet when left unused for a long period of time.
15. Object and Liquid Entry — Care should be taken so that objects do not fall and liquids are not spilled into the enclosure through openings.
16. Damage Requiring Service — The appliance should be serviced by qualified service personnel when:
 - A. The power-supply cord or the plug has been damaged; or
 - B. Objects have fallen, or liquid has been spilled into the appliance; or
 - C. The appliance has been exposed to rain; or
 - D. The appliance does not appear to operate normally or exhibits a marked change in performance; or
 - E. The appliance has been dropped, or the enclosure damaged.
17. Servicing — The user should not attempt service the appliance beyond that described in the operating instructions.

Important

Read the Following Before Operating the MD4S

Warnings

- Do not allow water to enter this unit or allow the unit to become wet. Fire or electrical shock may result.
- Connect this unit's power cord only to an AC outlet of the type stated in this Owner's Manual or as marked on the unit. Failure to do so is a fire and electrical shock hazard.
- Do not scratch, bend, twist, pull, or heat the power cord. A damaged power cord is a fire and electrical shock hazard.
- Do not place heavy objects, including this unit, on top of the power cord. A damaged power cord is a fire and electrical shock hazard. In particular, be careful not to place heavy objects on a power cord covered by a carpet.
- If you notice any abnormality, such as smoke, odor, or noise, or if a foreign object or liquid gets inside the unit, turn it off immediately. Remove the power cord from the AC outlet. Consult your dealer for repair. Using the unit in this condition is a fire and electrical shock hazard.
- Should this unit be dropped or the cabinet be damaged, turn the power switch off, remove the power plug from the AC outlet, and contact your dealer. If you continue using the unit without heeding this instruction, fire or electrical shock may result.
- If the power cord is damaged (i.e., cut or a bare wire is exposed), ask your dealer for a replacement. Using the unit with a damaged power cord is a fire and electrical shock hazard.
- Do not remove the unit's cover. You could receive an electrical shock. If you think internal inspection, maintenance, or repair is necessary, contact your dealer.
- Do not modify the unit. Doing so is a fire and electrical shock hazard.
- Do not insert or drop metal or flammable objects into the disc loading slot of this unit. Fire or electrical shock may result.

Cautions

- Allow enough free space around the unit for normal ventilation. This should be: 10 cm at the sides, and 10 cm behind.
These distances should also be adopted when rack-mounting the unit. For normal ventilation during use, remove the rear of the rack or open a ventilation hole.
If the airflow is not adequate, the unit will heat up inside and may cause a fire.
- Keep this unit away from the following locations:
 - Locations exposed to oil splashes or steam, such as near cooking stoves, humidifiers, etc.
 - Unstable surfaces, such as a wobbly table or slope.
 - Locations exposed to excessive heat, such as inside a car with all the windows closed, or places that receive direct sunlight.
 - Locations subject to excessive humidity or dust accumulation.
- This unit has ventilation holes at the top, and bottom to prevent the internal temperature rising too high. Do not block them. Blocked ventilation holes are a fire hazard.
- Turn off all musical instruments, audio equipment, and speakers when connecting to this unit. Use the correct connecting cables and connect as specified.

- Always lower the volume control to minimum before turning on the power to this unit. A sudden blast of sound may damage your hearing.
- Hold the power cord plug when disconnecting it from an AC outlet. Never pull the cord. A damaged power cord is a potential fire and electrical shock hazard.
- Do not touch the power plug with wet hands. Doing so is a potential electrical shock hazard.
- Do not raise the volume of headphones or speakers to a level that makes you feel uncomfortable. Listening to loud music for long periods can damage your hearing.
- Do not look at the laser beam. You may damage your vision.

Operating Notes

- The digital circuits of this unit may induce a slight noise into nearby radios and TVs. If noise occurs, relocate the affected equipment.
- XLR-type connectors are wired as follows:
pin 1: ground, pin 2: hot (+), and pin 3: cold (-).
- Insert TRS phone jacks are wired as follows:
sleeve: ground, tip: send, and ring: return.
- The performance of components with moving contacts, such as switches, rotary controls, faders, and connectors, deteriorates over time. The rate of deterioration depends on the operating environment and is unavoidable. Consult your dealer about replacing defective components.
- This unit must not be operated in a tilted position. Doing so can cause malfunctions.

Copyright

© 1998 Yamaha Corporation. All rights reserved.

No part of the MD4S software or this *Owner's Manual* may be reproduced or distributed in any form or by any means without the prior written authorization of Yamaha Corporation.

Trademarks:

MD DATA and MiniDisc are trademarks of Sony Corporation.

US and foreign patents licensed from Dolby Laboratories Licensing Corporation.

All other trademarks are the property of their respective holders.

Keep This Manual For Future Reference

Welcome to the MD4S

MD4S Features

Mixer

The mixer section is an analog mixer with four MIC/LINE and four LINE inputs.

- Continuously variable GAIN controls are provided on input channels 1–4, accepting signals ranging from mic input to line level.
- Of the four MIC/LINE inputs, two are balanced, allowing the use of either TRS phone plugs or XLR plugs.
- Input channels 1 and 2 provide INSERT I/O jacks that allow external effects such as a compressor to be connected.
- Input channels 1–4 provide three-band EQ (HIGH/MID/LOW) that has been specially engineered for musical applications.
- Two AUX SEND jacks allow external effects such as reverb to be connected.
- Signals sent from input channels 1–4 to the CUE bus (a signal route for monitoring) can be monitored in stereo.
- The mixer features an in-line design that allows the input signal and the track playback sound to be controlled simultaneously. While using the CUE bus to monitor each track, you can make full use of input channels 1–4 as you record. During mixdown, a total of eight sources (including track playback signals) can be mixed.
- TRACK DIRECT OUT jacks are provided for direct output of the playback from each track.

Recorder

The recorder features a 4-track recorder based on the MD DATA audio format. This provides many advantages over tape-based multitrack recorders.

- You can choose from three recording modes: 4 track, 2 track, monaural.
- Negligible decrease in audio quality even after repeated ping-pong operations.
- Ping-pong is possible even if all four tracks have been recorded.
- A variety of locate functions allow you to move instantly to any location in the song.
- Accurate auto punch-in/out can be performed with 11.6-millisecond accuracy.
- A variety of editing functions allow you to copy or erase songs and tracks.
- A variety of repeat functions allow songs or portions of a song to be repeated seamlessly.
- The multi-take auto punch-in/out function lets you repeat auto punch-in/out several times, and select the best take afterward.
- Shuttle playback allows rapid playback / reverse-playback at speeds of 1/2, 2x, 4x, 8x, 16x, or 32x normal speed. (Forward playback only for 1/2 speed.)
- Program Play function lets you program the playback order of songs. In addition, Cue List Playback lets you freely program the playback order between markers.

- The recording/playback pitch can be adjusted up to a maximum of $\pm 10\%$. In addition, you can use the x1/2 play function to playback at half-speed with a pitch that is one octave lower.
- MIDI Time Code (MTC) / MIDI Clock data can be transmitted from the MIDI OUT connector. This allows synchronization with a MIDI sequencer or rhythm machine without using up a recording track. In addition, MTC from an external device can be received at the MIDI IN connector, allowing the MD4S to be synchronized to external video/audio devices.
- MIDI Machine Control (MMC) can be received, allowing the transport of the MD4S to be controlled from a MIDI sequencer or other external device.



Buying discs for the MD4S

The MD4S can use two types of disc: MD DATA and MiniDisc. MD DATA discs can be used for 4-track recording/playback, and MiniDiscs can be used for recording/playback of up to two tracks. (They cannot be used for 4-track recording/playback.)

MD DATA and MiniDisc

MD DATA are widely used for computer data storage, and the MD4S uses the audio format of this type of disc.

MiniDiscs (also known as MD) are used only for music.

Type	MD DATA	MiniDisc
Logo		
4-track recording/playback	Yes (37 minutes per track)	No
2-track recording/playback	Yes (74 minutes)	Yes (74 minutes)
Monaural recording/playback	Yes (148 minutes)	Yes (148 minutes)
Notes	<ul style="list-style-type: none"> • These discs are for computer storage applications, and can be purchased at computer shops. Two types are available: playback-only and rewritable. Use the <u>rewritable type</u> with the MD4S. • MD DATA discs recorded on the MD4S cannot be played back on a conventional MD player. • MD DATA discs that have been used to store computer data cannot be used as is by the MD4S. Such discs must first be formatted for audio use. See <i>"Erasing a disc (Disc Erase)"</i> on page 86 for more information. • Songs that were recorded in 8-track mode on a recorder such as the MD8 cannot be played back on the MD4S. 	<ul style="list-style-type: none"> • These discs are for music. Two types are available: playback-only and rewritable. If you use the rewritable type, you can record up to two tracks. • MiniDiscs recorded on the MD4S can be played back on a conventional MD player. • MiniDiscs recorded on a conventional MD recorder can be edited on the MD4S, but if the music includes a song that was digitally copied from a copy-protected music CD, editing will not be possible.

MD4S TOC

TOC refers to the Table of Contents area on the disc. The TOC contains information about what is recorded on the disc, the disc title, song titles, and so on.

When you record a new song or edit the song title, the TOC EDIT indicator of the MD4S will light to indicate that the TOC needs to be updated.



If the TOC EDIT indicator is lit, you must update the TOC before turning off the power of the MD4S. If the power is turned off when the TOC EDIT indicator is lit, the data you recorded or edited will be lost.

To update the TOC

Press the STOP button, and with the MD4S stopped, press the TOC WRITE button. (The STOP button and the TOC WRITE button are the same button.)

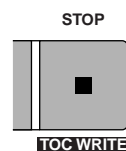

The display will show “Writing TOC,” indicating that the TOC is being written to disc. When the TOC has been updated, the “Writing TOC” display and the TOC EDIT indicator will go dark.

Note: If you press the EJECT button while the TOC EDIT indicator is lit, the TOC will automatically be updated before the disc is ejected.

Recording modes and recording times

The MD4S offers three recording modes: 4-track (4TR), 2-track (2TR), and monaural (MONO). The times available for recording on a single disc will depend on the recording mode. Available recording/playback times will be 37 minutes in 4TR mode, 74 minutes in 2TR mode, and 148 minutes in MONO mode. You can use a different recording mode for each song, which allows you to make the most efficient use of each disc.

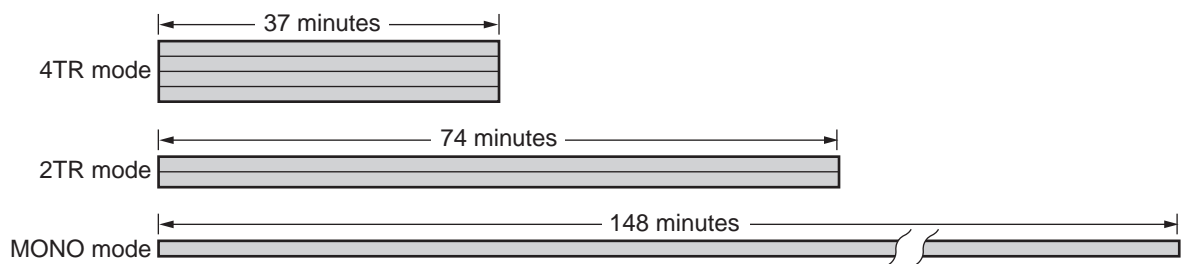

MD4S songs and blank areas

On the MD4S, recordings are made in units called “songs.” Each song is assigned a number indicating the order in which it was recorded. For example if you have recorded two songs on a disc, song 2 will be recorded immediately after song 1, as shown in the following diagram.

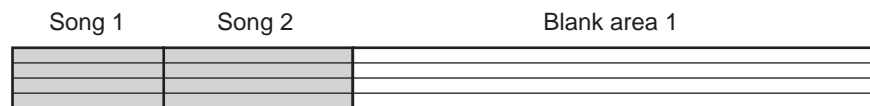

When you record a new song or record additional material onto a previously-recorded song to lengthen it, the new recording is done only on the unrecorded portion of the disc; the “blank area.” In the diagram above, it is possible to record a new song (song 3) in the blank area, or to record additional material onto song 2 to lengthen it. However since there is no blank area immediately after song 1, it is not immediately possible to record additional material to song 1 to lengthen it.

Tip: If you wish to lengthen song 1, you will need to use a song editing function to move song 1 to the blank area.

If three songs (songs 1, 2, and 3) are recorded consecutively on disc as shown in the following diagram, and the middle song is erased, there will be a blank area corresponding to the length of that song.

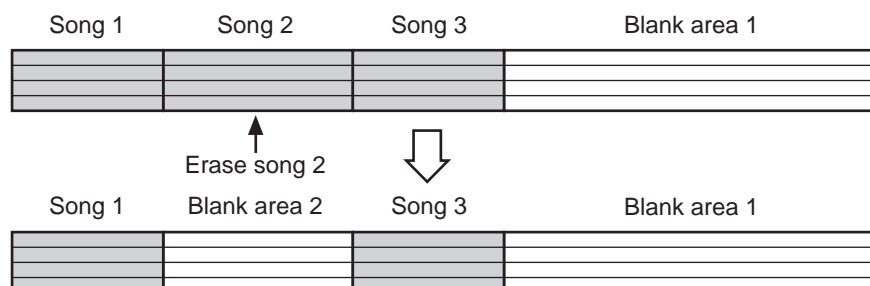

* Blank areas are also assigned a “blank area number” in the order in which they are created.

If you then record a song in the situation shown above, you will be able to select either blank area 1 or blank area 2 in which to record. However if you select blank area 2, the time available for recording will be limited to the length of the song that was erased.

Front and rear panel

This section explains the names and functions of each part of the MD4S.

Mono Inputs

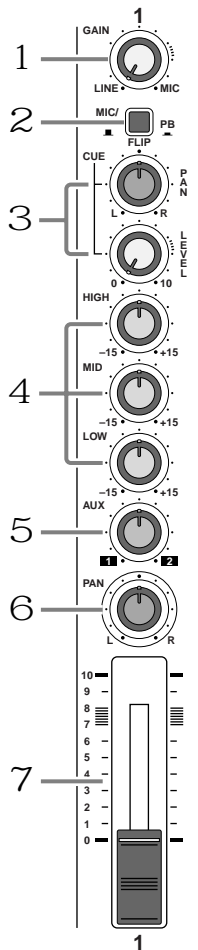

A GAIN control

This adjusts the input sensitivity of the MIC/LINE input jack (jacks 1 and 2 on the top panel). Input channels 1–4 can accommodate signals of any level from mic input to the line level signals produced by devices such as synthesizers.

B FLIP switch

This switch selects the signal source for the input channel and the signal source that is sent to the CUE bus for monitoring.

When this switch is in the MIC/LINE position (■), the signal from the MIC/LINE jack will be sent to the input channel, and the track signal (the signal currently being recorded or played back) will be sent to the CUE bus.

When this switch is in the PB position (▬), the signal from the track will be sent to the input channel, and the signal from the MIC/LINE jack will be sent to the CUE bus.

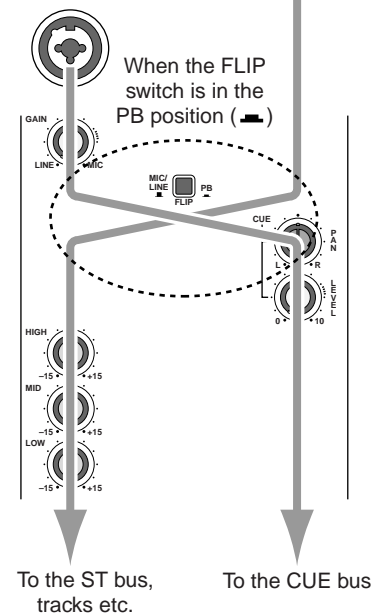
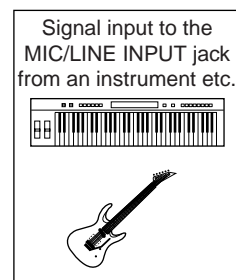
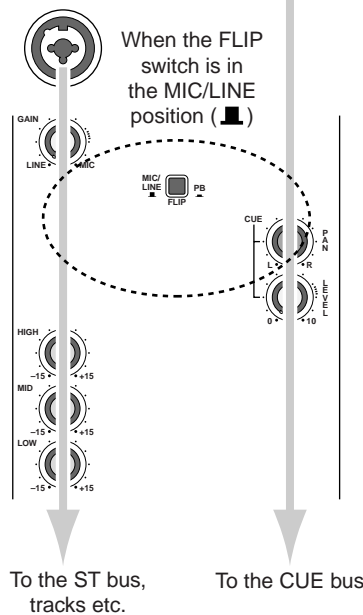
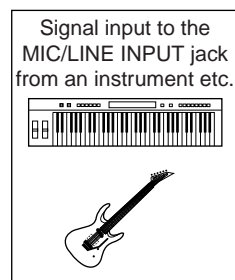

C CUE PAN/CUE LEVEL controls

These two controls adjust the pan and signal level of the signal that is sent to the CUE bus. The signal that is sent to the CUE bus will depend on the setting of the FLIP switch 2 .

D EQ controls

These controls are used to adjust the high, middle, and low frequency bands. Each can boost (amplify) or cut (attenuate) the frequency bands shown below over a range of ± 15 dB. Each knob is detented at the 12 o'clock position, which produces a flat response (no boost or cut).

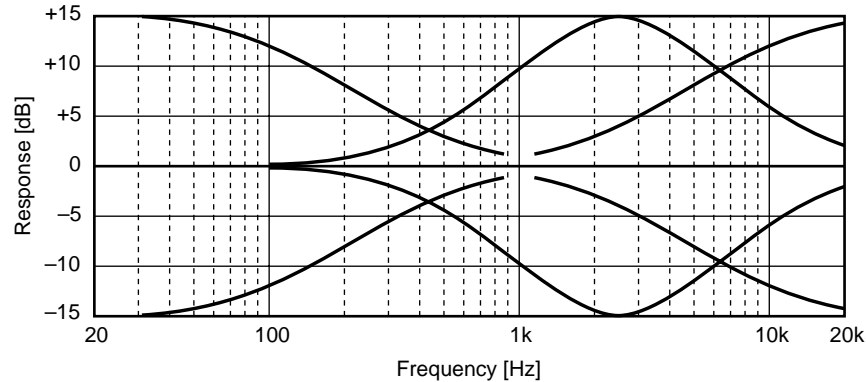

HIGH (high range): 10 kHz (shelving)

MID (mid range): 2.5 kHz (peaking)

LOW (low range): 100 Hz (shelving)

E AUX control

This control sends the signal from the input channel to the AUX SEND jacks. Rotating the knob toward the “1” position will send the signal from the input channel to the AUX SEND 1 jack, and rotating the knob toward the “2” position will send the signal to the AUX SEND 2 jack. The knob is detented at the 12 o'clock position, and at this position no signal will be sent to either AUX SEND jack 1 or 2. The AUX controls are normally used to adjust the signal level that is sent to external effect devices.

Note: The AUX control is “post-fader”; i.e., it adjusts the level of the signal that has passed through the fader 7 . This means that if the fader has been lowered, the AUX control will have no effect.

F PAN control

This control adjusts the pan (left/right position) of the input channel signal that is sent to the ST bus. If you are recording via the ST bus, rotating this control to the L position will assign the input signal to odd-numbered tracks (tracks 1 and 3), and rotating it to the R position will assign the input signal to even-numbered tracks (tracks 2 and 4). During mixdown, use this control to adjust the stereo position of the playback for each track.

G Fader

During recording (when the FLIP switch is at MIC/LINE), use the fader to adjust the input level of the signal being recorded on the track. During mixdown (when the FLIP switch is at PB), use the fader to adjust playback level of each track. The fader will be at unity gain when located between 7 and 8.

Unity gain: This refers to a condition where the output signal and input signal levels are the same, which will produce the least distortion and the optimal S/N ratio.

Stereo Inputs

H Level (5/6), (7/8) controls

These controls adjust the level of the signals input from STEREO INPUT jacks 5/6 or 7/8. These input signals are always sent to the ST bus, and are mixed with the signals from input channels 1–4 and the playback signals of the tracks.

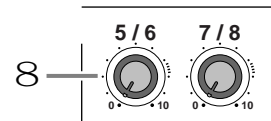

Monitor/Master section

I CUE MIX TO STEREO switch

This switch turns the cue mix function on/off. When the switch is pressed in (■), the CUE MIX indicator in the display will light, and the signal from the CUE bus will be mixed into the ST bus. The cue mix function can be used only during playback, and is normally used when adding sounds during mixdown (page 42).

J MONITOR SELECT switches

These switches select the signal that will be monitored from the MONITOR OUT jacks (rear panel 4) and the PHONES jack (front panel 1). When the switch is pressed in, the corresponding source is selected (on). When the switch is up, the signal will not be selected (off). The three switches can be turned on/off independently.

2TR IN Monitor the signal that is input from the 2TR IN jacks (rear panel 6).

STEREO Monitor the ST bus signal that is output from the STEREO OUT jacks (rear panel 5).

CUE Monitor the CUE bus signal.

K MONITOR LEVEL control

This control adjusts the output level of the monitor signal that is sent to the MONITOR OUT jacks (rear panel 4) and the PHONES jack (front panel 1).

L STEREO fader

This adjusts the output level of the ST bus that is output from the STEREO OUT jacks (rear panel 5). The fader will be at unity gain when located between 7 and 8.

Unity gain: Refer to the explanation of 7 Fader.

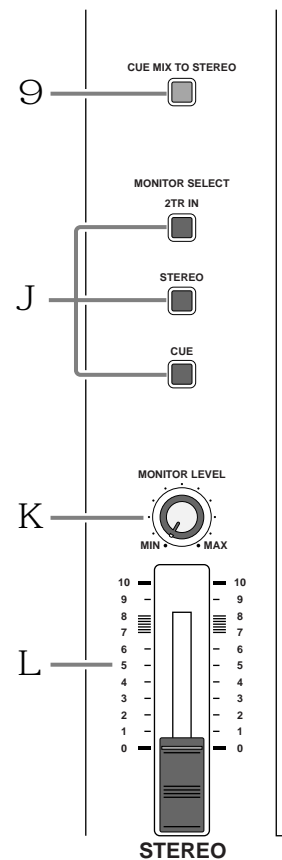

Disc transport section

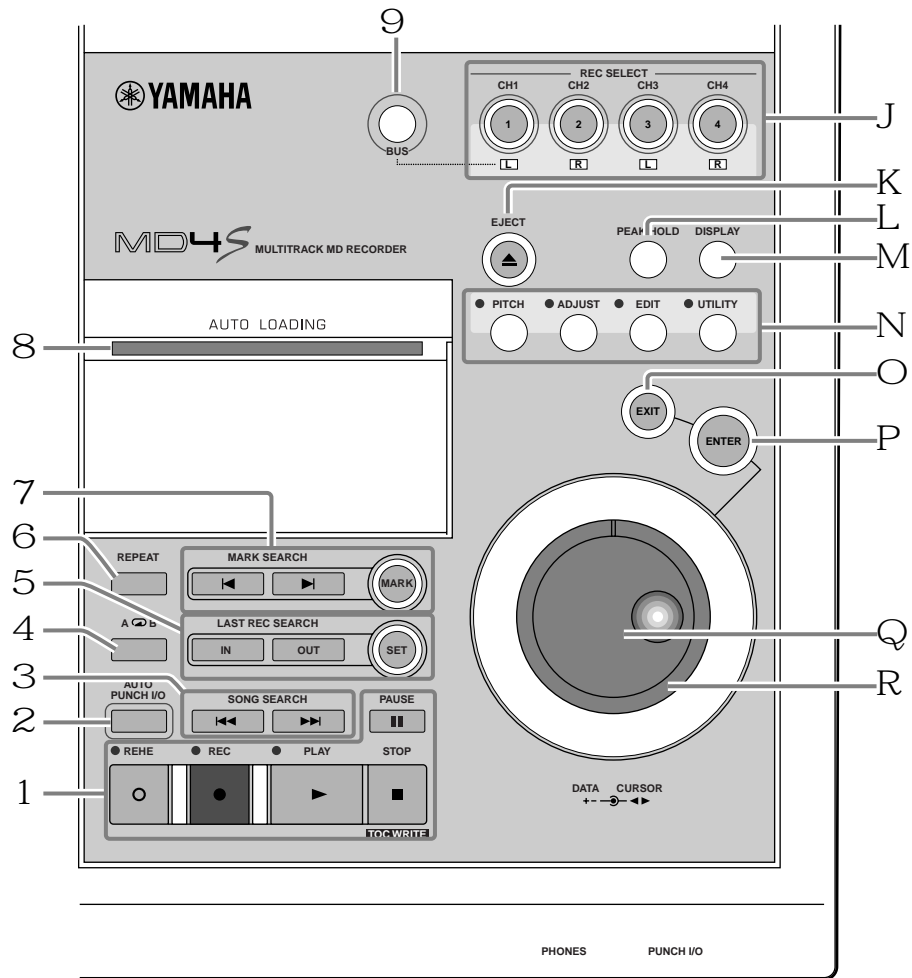

* Please remove the protective film from the panel.
If the film is left on, the adhesive may break down and soil the unit.

A Disc transport buttons

REHE button This button is used to rehearse punch-in/out. During rehearsal the REHE indicator located above the button will light, and while rehearsal is paused the indicator will blink.

REC button This button is used to record. When you press the REC button during playback, recording will begin from that location on any recordable track(s). (See “Manual punch-in/out” on page 52 for more information.) The REC indicator located above the button will light during recording, and will blink to indicate record pause.

PLAY button This button is used to begin normal playback, recording, and rehearsal. After pressing the REHE button, pressing the PLAY button will enter rehearsal mode. After pressing the REC button, pressing the PLAPY button will begin recording. If you press the PLAY button without pressing the REHE or REC button, normal playback will begin. During playback/recording/rehearsal, the PLAY indicator located above the button will light. When playback/recording/rehearsal is paused, the PLAY indicator will blink.

PAUSE button This button temporarily halts (pauses) playback/recording/rehearsal. After operation has been paused, pressing the PAUSE button once again will resume playback/recording/rehearsal from that location.

- STOP/TOC WRITE button**..... This button stops playback/recording/rehearsal. When stopped, this button functions as the TOC WRITE button to update the TOC (page 11).
- B AUTO PUNCH I/O button**
This button turns the auto punch-in/out function on/off. When auto punch-in/out is on, the auto punch indicator in the display (display K) will light.
- C SONG SEARCH [◀◀]/[▶▶] buttons**
These buttons search for the starting locations of songs or blank areas. They are used to search for and move to the beginning of songs.
- D A↔B repeat button**
This button sets the A and B points of the A-B repeat function (page 68).
- E LAST REC SEARCH [IN]/[OUT], SET buttons**
The LAST REC SEARCH [IN]/[OUT] buttons locate to the points at which recording or rehearsal were last started (last record IN point) or last ended (last record OUT point). In conjunction with the SET button, these buttons can be used to specify any desired location in a song as the last record in/out point (punch-in/out point).
- F REPEAT button**
This button is used to select functions such as “one song repeat” which repeatedly plays back a single song, or “all song repeat” which repeatedly plays back all songs on the disc, and is also used to switch the repeat function on/off. The repeat indicator (display ○) will light to indicate the repeat function that is selected.
- G MARK SEARCH [◀]/[▶], MARK buttons**
The MARK SEARCH buttons are used to locate to the Start marker (beginning of the song), End marker (end of the song), or to markers that you can set at desired locations in the song. The MARK button is used to insert a marker into the desired location of a song.
- H Disc compartment**
An MD DATA or MiniDisc can be inserted here.
- I BUS button**
This button is used in conjunction with the REC SELECT buttons J to specify the tracks on which the ST bus signal will be recorded.
- J REC SELECT buttons**
These buttons select/defeat recording tracks. Tracks selected for recording will be indicated by the track record indicators (display J) in the display.
- When you press only a REC SELECT button**
Recording will be enabled for the corresponding track, and the signal from input channels 1–4 will be sent directly to the track (direct recording).
- When you hold down the BUS button and press a REC SELECT button**
Recording will be enabled for the corresponding track. The L channel of the ST bus will be sent to tracks 1 and 3, and the R channel of the ST bus signal will be sent to tracks 2 and 4.
- K EJECT button**
This button ejects the disc from the MD4S. If you press the EJECT button while the TOC EDIT indicator (display 1) is lit, the TOC will be updated before the disc is ejected.

L PEAK HOLD button

This button turns the peak hold function on/off. When the peak hold function is on, a segment of the track/stereo level meters will remain lit to indicate the maximum level that was reached. When the peak hold function is on, pressing the PEAK HOLD button once again will turn off the peak hold function, and the segment that had remained lit will be reset.

M DISPLAY button

This button selects the time counter mode (ELAPSE TIME / TOTAL TIME / REMAIN TIME). The selected time counter mode will be shown in the display (display 5). If a tempo map has been programmed for the MD4S, this button will switch the time counter between measure/beat/clock displays.

N Function buttons

These buttons are used to access a variety of functions. When a button is pressed to access the corresponding function, the indicator located above the button will light.

PITCH button..... Selects functions to adjust the pitch for playback and recording (page 84). According to the setting, the pitch indicator in the display will indicate "FIX" (fixed) or "VARI" (variable).

ADJUST button.. Allows you to make fine adjustments to the markers or last recording in/out points that you have set within a song (page 63).

EDIT button Accesses a variety of editing functions, and allows you to specify a disc title or song title.

UTILITY button... Allows you to use MIDI functions, adjust the display contrast, and change the recording mode etc.

O EXIT button

Use this button to cancel a function or mode.

P ENTER button

Use this button to set functions.

Q DATA dial (DATA+ -)

When the MD4S is stopped or paused, rotating the DATA dial will move through the song in frame steps. When editing various functions (when one of the function buttons has been pressed), the DATA dial is used to modify parameter values.

R CURSOR shuttle

When the MD4S is stopped or paused, rotating the CURSOR shuttle allows you to rapidly rewind or fast-forward through the song. During playback, the CURSOR shuttle allows you to review (play backward) or cue (play forward) at a variety of speeds (Shuttle playback functions: page 66). While editing various functions, the CURSOR shuttle is used to select parameters.

Display

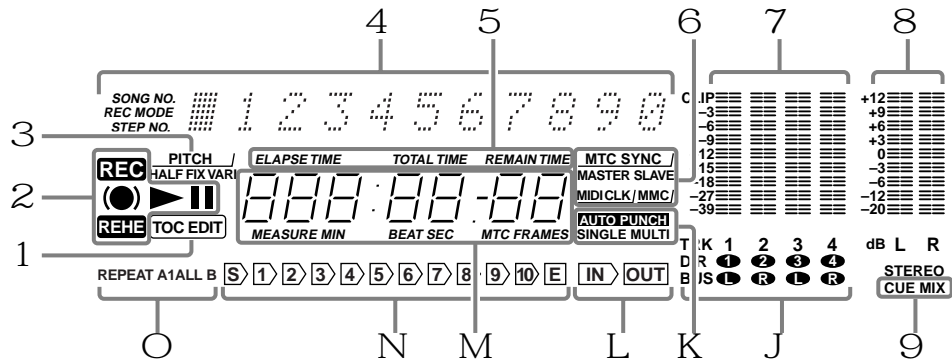

A TOC EDIT indicator

This indicator will light when the TOC (table of contents) needs to be updated, such as after a new recording or edit. If the power of the MD4S is turned off while the TOC EDIT indicator is lit, the recorded or edited content may be lost. When you update the TOC, the indicator will go dark.

B Status indicators

These indicators show the current operating mode.

Indicator	Meaning
	Normal playback Cue or Review
	Playback is paused
	Rehearsal Pause mode
	Rehearsal in progress
	Record Pause mode
	Recording in progress

C Pitch indicator

This indicator shows the current pitch mode. The status of the x1/2 Play function is also shown here.

HALF..... Lights when the x1/2 Play function is on.

FIX..... Lights when the Pitch function is off.

VARI..... Lights when the Pitch function is on.

D Title and function display

Song numbers, song/disc titles, the currently selected function, or other messages will appear here.

E Time counter mode

This indicates the time counter mode that was selected by the DISPLAY button (disc transport M). However if a tempo map has been programmed and the time counter is showing measure/beat/clock, all of these indicators will be dark.

ELAPSE TIME The time counter will show the current elapsed time within the song.

TOTAL TIME..... The time counter will show the time position within the entire disc.

REMAIN TIME The time counter will show the remaining time within the son

F MIDI indicators

The status of various MIDI functions is shown here.

MTC SYNC MASTER This will light when you enable MTC transmission. In this case, the MD4S will transmit MTC and will function as the master of a synchronized MIDI system.

MTC SYNC SLAVE..... This will light when you enable MTC reception. In this case, the MD4S will receive MTC and will function as a slave in a synchronized MIDI system.

MIDI CLK This will light when you enable MIDI Clock transmission. In this case, the MD4S will transmit MIDI Clock and will function as the master of a synchronized MIDI system.

MMC This will light when you enable MMC (MIDI Machine Control) reception. In this case, the MD4S can be controlled from an external device such as a MIDI sequencer.

G Track level meters

These indicate the recording/playback level of each track. The range from -39 dB to CLIP is shown in nine steps. The CLIP indicator will light to indicate that digital clipping has occurred in the signal. If no disc is inserted, these meters will indicate the input levels of input channels 1-4.

H Stereo level meter

This meter indicates the output level of the STEREO OUT jacks. The range from -20 dB to +12 dB is shown in nine steps.

I CUE MIX indicator

This indicates the on/off status of the cue mix function. If you record while the cue mix function is on, this indicator will blink, indicating that the cue mix function has been temporarily turned off.

J Track recording indicators

These indicate the recording status of each track. When a indicator is blinking, the corresponding track is ready to record. When recording begins, the blinking indicator will light solidly.

DIR/1-4 These indicate tracks that have been selected for direct recording (in which the signal from the input channel is recorded directly).

BUS/L, R These indicate tracks that have been selected for recording the signal from the ST bus (L or R channel).

K Auto punch indicator

This indicator shows the status of the auto punch-in/out function.

AUTO PUNCH SINGLE..... This will light when you select Single Take Auto Punch-in/out (in which auto punch-in/out will occur only once).

AUTO PUNCH MULTI..... This will light when you select Multi Take Auto Punch-in/out (in which you can perform auto punch-in/out repeatedly, and then select the best take).

L IN, OUT indicators

These show the status of the last record in (IN)/out (OUT) points.

IN This will light if the Last Record In Point (auto punch-in point) has been set. During auto punch-in/out, this indicator will go dark when the song reaches or passes the specified IN point.

OUT This will light if the Last Record Out Point (auto punch-out point) has been set. During auto punch-in/out, this indicator will go dark when the song reaches or passes the specified OUT point.

M Time counter

This indicates time locations on the disc in minutes/seconds/frames. When transmitting MIDI Clock data, the minutes/seconds/frames display can be changed to measures/beats/clocks. (In this case, the MEASURE and BEAT indicators will light.)

N Marker indicators



These indicate the status of the various markers that have been set within the song. When a marker is set, the corresponding indicator will light. When a song passes a marker point that has been set, the corresponding indicators will blink.

S Start marker (beginning of the song)

1–10 Marker numbers 1–10 that were set at desired locations in the song using the MARK button.

E End marker (end of the song)

O Repeat indicator

This indicates the repeat function that has been selected by the REPEAT button (disk transport , or the A  B button (disk transport ).

REPEAT 1 One Song Repeat

REPEAT ALL All Song Repeat

REPEAT A B A-B repeat

REPEAT + auto punch indicator K Auto punch-in/out is rehearsed repeatedly

Top panel connectors

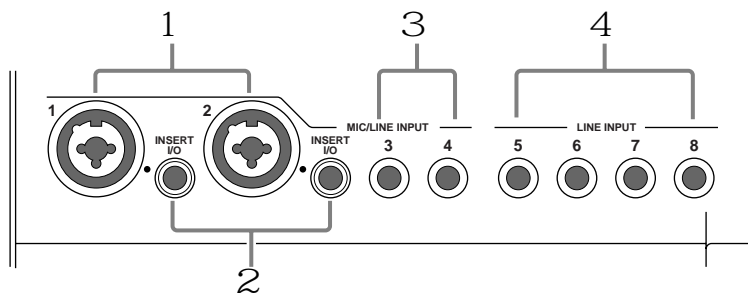

A MIC/LINE INPUT 1,2 jacks

Balanced condenser mics or line-level devices with balanced output can be connected to these inputs. Unbalanced outputs such as on synthesizers can also be connected here. These jacks will accommodate either XLR plugs or TRS phone plugs.

B INSERT I/O jacks

These are TRS phone jacks for connecting external effect devices. By connecting an external effect such as a compressor or noise gate to these jacks, you can process the signal of input channels 1 and 2.

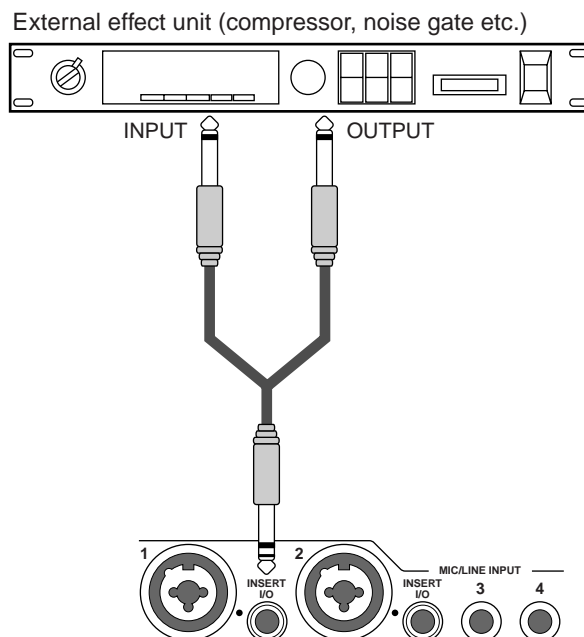

C MIC/LINE INPUT 3, 4 jacks

These are 1/4" phone jacks used to connect electronic instruments such as a synthesizer or an unbalanced mic.

D LINE INPUT 5–8 jacks

These are 1/4" phone jacks used to connect line-level devices such as synthesizers or CD players. They can also be used as effect return jacks to input the effect sound from external effect units such as reverb.

Rear panel

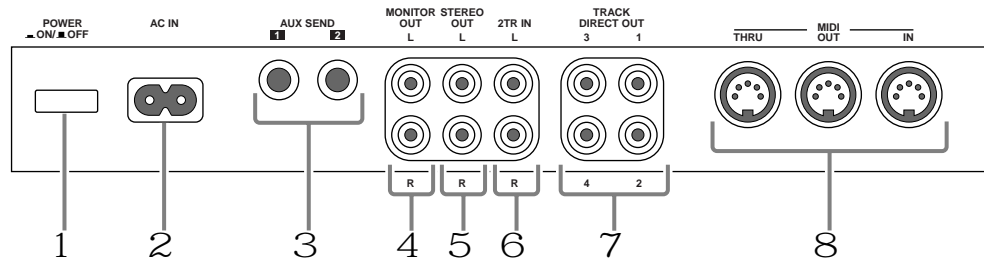

CAUTION

TO PREVENT ELECTRIC SHOCK,
MATCH WIDE BLADE OF PLUG TO
WIDE SLOT, FULLY INSERT.

A POWER switch

This switch is used to turn the MD4S on and off.

B AC IN

Connect the included power cable here.

C AUX SEND 1, 2 jacks

These are 1/4" phone jacks that output the signals from the input channels as adjusted by the AUX controls (input channel 5). Normally they are used as effect send jacks to send signals to external effect processors (page 45).

D MONITOR OUT jacks

These are RCA phono jacks that output the monitor signal selected by the MONITOR SELECT switch (monitor/master J). Connect them to your hi-fi system or to amplified monitor speakers.

E STEREO OUT jacks

These are RCA phono jacks that output the signal of the ST bus that has passed through the STEREO fader (monitor/master L). During mixdown, connect these jacks to the inputs of your master recorder.

F 2TR IN jacks

These are RCA phono jacks for connecting a line-level stereo device. Normally they are connected to the output jacks of your DAT or other master recorder.

G TRACK DIRECT OUT 1–4 jacks

These are RCA phono jacks which individually output the signals from tracks 1–4 (the signals currently being recorded/played). Normally they are used to connect the MD4S to the input jacks of a large mixer when you wish to use an external mixer to mix the playback of the MD4S recorder tracks.

H MIDI IN, OUT, THRU connectors

These connectors are used to exchange MIDI messages with external MIDI devices.

MIDI OUT connector.....MIDI Clock and MIDI Time Code (MTC) is output from this connector. This is used when synchronizing the MD4S with a MIDI sequencer or rhythm machine.

MIDI IN connector.....MTC or MMC (MIDI Machine Control) is received at this connector. This is used when controlling the transport of the MD4S from an external MIDI sequencer.

MIDI THRU connector.....MIDI messages received at the MIDI IN connector are retransmitted without change from this connector to another external MIDI device.

Front panel

A PHONES jack

A pair of stereo headphones can be connected here for monitoring. This jack will output the same signal as the MONITOR OUT jacks.

B PUNCH I/O jack

A Yamaha FC5 (sold separately) can be connected here, allowing you to use a foot switch to start/pause playback, start/pause rehearsal, or punch-in/out. (See *“Using a Foot switch”* on page 89 for more information.)

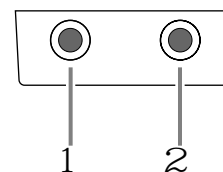

Basic operation

This chapter explains the process of recording instruments separately on each of the four tracks, and finally mixing down to a master recorder.

Before you begin

Example connections

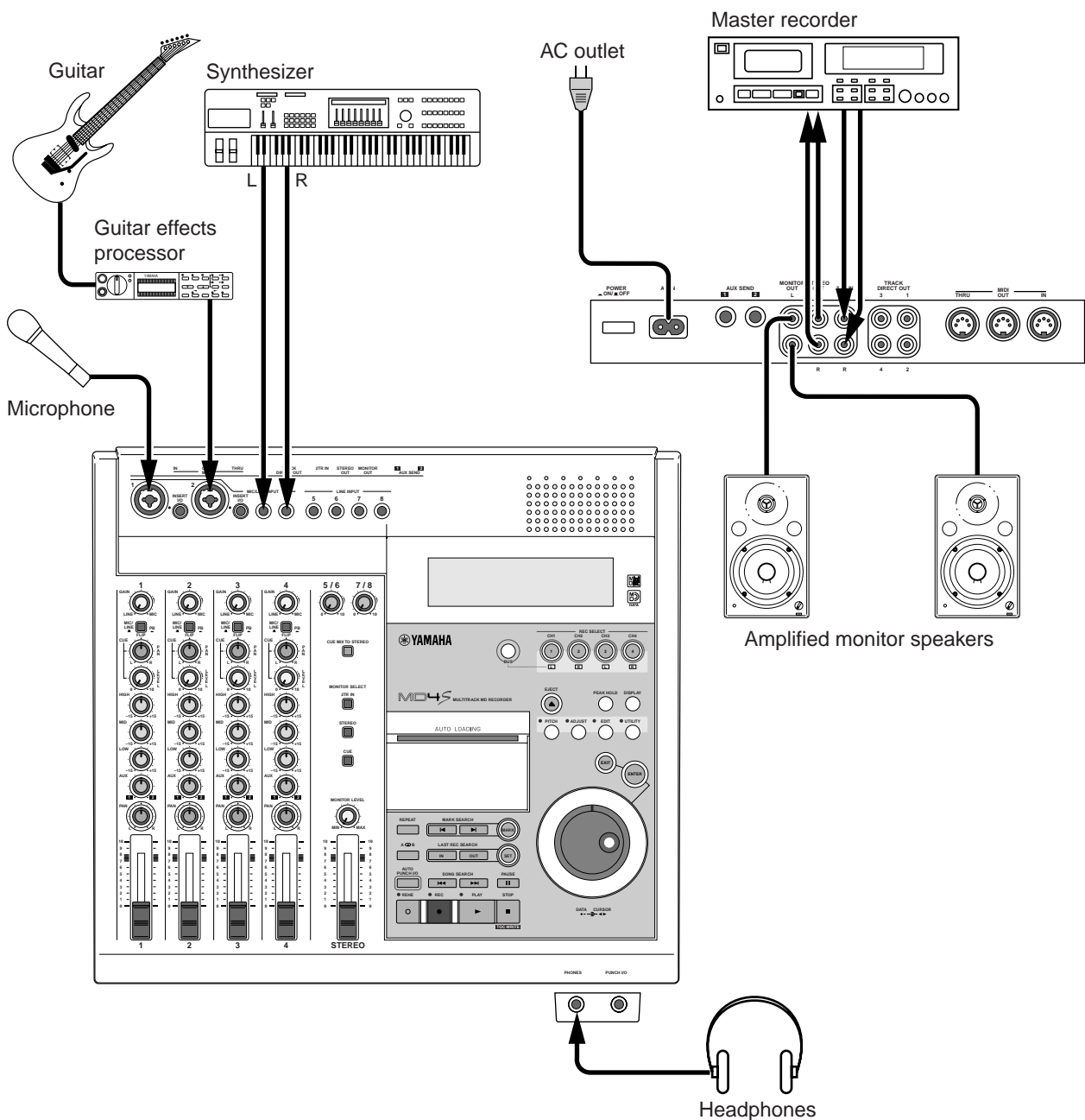

Turning on the MD4S

1. Plug the power cable into an AC outlet.
2. Press the POWER switch located on the rear panel of the MD4S. When the power is turned on, the display will light.

To turn off the MD4S, press the POWER switch again.

Inserting a disc

Make sure that the write protect slider of the disc is in the write permit position.

1. With the arrow printed on the disc pointing away from yourself, slide the disc gently into the disc compartment.

The disc will be pulled in automatically. If not, check that the arrow is pointing the correct direction.

When a disc is inserted into the MD4S, the TOC will be read to see what the disc contains. If the disc is new, the display will indicate "Blank Disc." If songs have already been recorded on the disc, the disc title will appear for several seconds, and then the number of songs on the disc (e.g., "Total 004") will appear.

Recording the first track (Direct Recording)

On the MD4S, the signals that are input to the MIC/LINE INPUT jacks 1–4 can be recorded directly to tracks 1–4 (direct recording). Since you simply need to connect the audio source to MIC/LINE INPUT jack 1 if you wish to record on track 1, or to MIC/LINE INPUT jack 3 if you wish to record on track 3, this method is convenient when you will be recording each part separately.

In this example, we will explain how to record your first audio source on track 1.

Preparations for recording

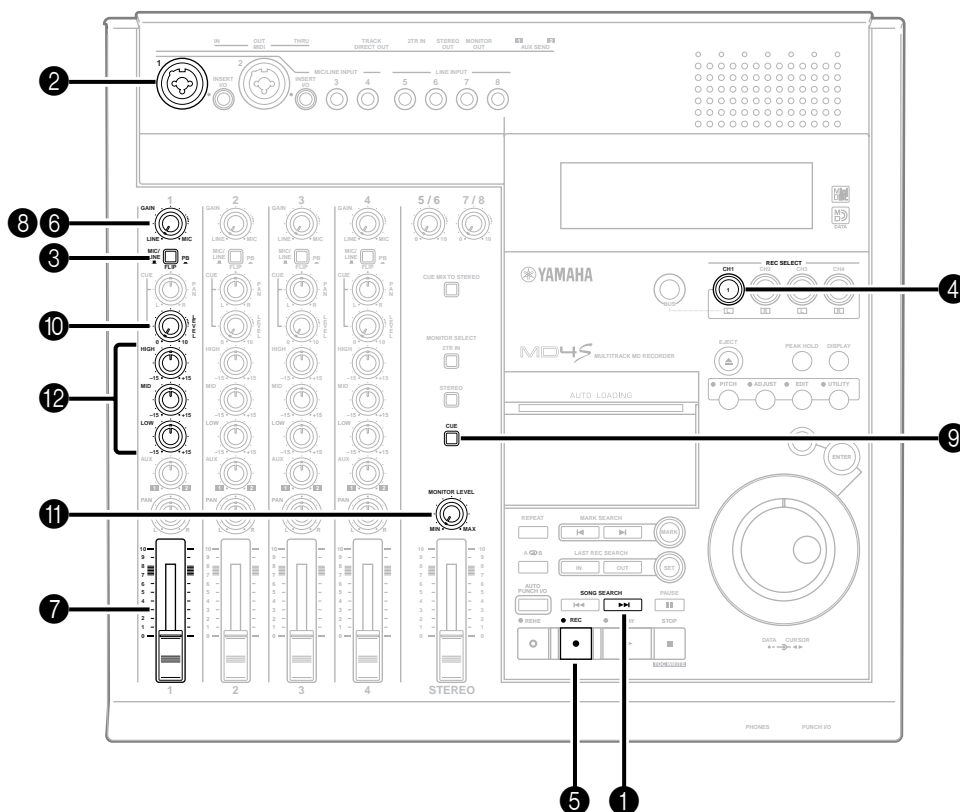

■ Find a blank area

A new song can be recorded only on a blank area. If you wish to record a new song on a disc that already contains recorded material, you must begin by finding a blank area.



- 1 Press the SONG SEARCH [▶▶] button several times to find the blank area.

When a blank area has been found, the display will indicate “BLANK X” (where X is the number of the blank area).

Note: Since new discs (or discs that have been erased) are entirely blank, this step is not necessary.

Note: With normal recording operations, there will be only one blank area. However if you move or delete songs, multiple blank areas may be created. (See “*Editing functions*” on page 73 for more information.) If there is more than one blank area, the time available for consecutive recording may differ depending on the size of the blank area. (See “*MD4S songs and blank areas*” on page 12 for more information.)

Tip: If you press the DISPLAY button to set the display time counter mode to REMAIN TIME, the length of available recording time for each blank area will be shown when you search to that blank area.

■ Select the track for recording

- 2 Connect your audio source to MIC/LINE INPUT jack 1.
Normally, you will record the rhythm instruments (rhythm machine, drums, or rhythm guitar etc.) first.

- 3 Set the FLIP switch of input channel 1 to “MIC/LINE (■).”

When you set the FLIP switch to the “MIC/LINE (■)” position, the input signal from the MIC/LINE INPUT jack will be sent to the corresponding input channel.

- 4 Press REC SELECT button 1.

The REC SELECT buttons are switches that select the recording source for each track. When you press REC SELECT button 1, track 1 will be ready for recording, and the signal from input channel 1 will be sent directly to track 1. The track recording indicator (DIR) for track 1 will blink.

■ Check the recording level

To insure the best audio quality for the recording, it is important to set an appropriate recording level. Always be sure to adjust the recording level before you begin recording.

- 5 Press the REC button.
The REC indicator will blink, and the MD4S will be in record-pause mode. The display will indicate the number of the song to be recorded (001), and if this is the first time you are recording the song, the display will indicate “NEW REC.”
- 6 Rotate the GAIN control of input channel 1 all the way to the LINE position.
- 7 Set the input channel 1 fader between the 7 and 8 marks.
- 8 While playing your audio source, watch the track level meter and rotate the GAIN control once again to adjust the recording level.
Ideally, the track level meter will indicate about -3 for the loudest sounds. If the recording level is too high even when the GAIN control is rotated all the way to the LINE position, lower the output level of the audio source.

Tip: If you press PEAK HOLD to turn on the Peak Hold function, the level meter will hold the maximum level that was reached. For details on the PEAK HOLD button, refer to page 18.

■ Monitor the signal being recorded on the track

- Press the MONITOR SELECT CUE switch to turn it on.

The MONITOR SELECT switches choose the signal source that will be monitored. When the CUE switch is on, the signal from the CUE bus will be sent to the PHONES jack and the MONITOR OUT jacks, allowing you to monitor the sound through headphones or monitor speakers.

- Raise the CUE LEVEL control of input channel 1 to the 7–8 mark.

The CUE LEVEL controls of input channels 1–4 adjust the signal that is sent from tracks 1–4 to the

CUE bus (for tracks that are in record/record-pause mode this will be the recording source, or for tracks that are playing back this will be the playback sound of the track).

- While listening to your headphones or monitor speakers, adjust the MONITOR LEVEL control to an appropriate volume.
- As desired, use the EQ controls to adjust the tone.

Adjusting the EQ controls will affect the recording level. When you finish adjusting the EQ controls, use the GAIN control to re-adjust the recording level as necessary.

Start recording

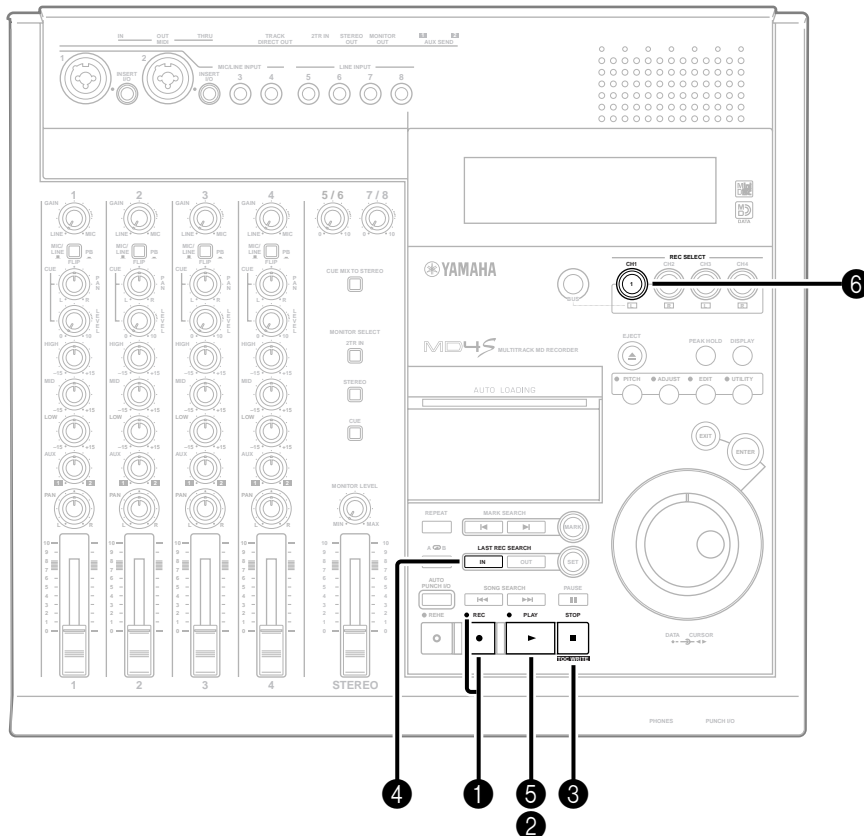

■ Begin recording

- Make sure that the REC indicator is blinking. If it is not blinking, press the REC button.
- Press the PLAY button. Recording will begin, and the track 1 track record indicator and the REC indicator will change from blinking to lit. Begin playing the audio source that you wish to record first.

- When you finish recording, press the STOP button.

The transport will stop, and the track record indicator of track 1 will change to blinking.

The display will indicate “Writing TOC” for a short time, and then the TOC EDIT indicator will go dark, indicating that the TOC has been updated automatically.

■ Listening to the first track

- 4 Press the LAST REC SEARCH [IN] button.
This will locate to the point at which the previous recording was begun. (For details on the LAST REC SEARCH buttons, refer to page 17.) If this was the first recording, you will always return to the “00:00.00” location.
- 5 Press the PLAY button.
If the input channel 1 FLIP switch is in the “MIC/LINE (■)” position, the playback of track 1 can be monitored (via the CUE bus) from the PHONES jack or MONITOR OUT jacks.

If you decide to re-record this take, press the LAST REC SEARCH [IN] button, and repeat steps 1–4. If you wish to re-record just a portion of the track, you can use punch-in/out. See “Punch-in/out” on page 52 for more information.

- 6 If you are satisfied with the recording on track 1, press the REC SELECT switch.
The track 1 track record indicator (DIR) will go dark.

Note: If you forget to press the REC SELECT switch, track 1 will be erased when you record the next track.

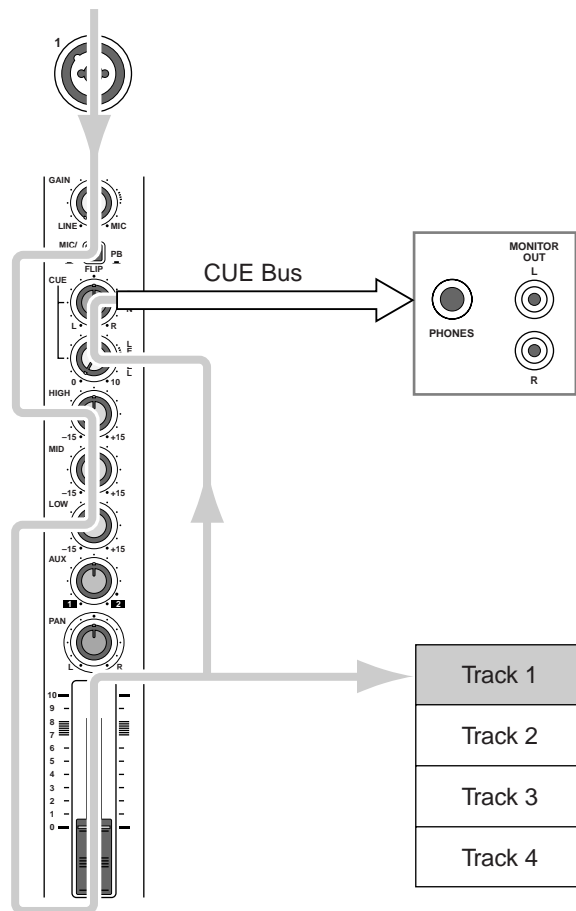



Signal flow during track recording

Overdubbing

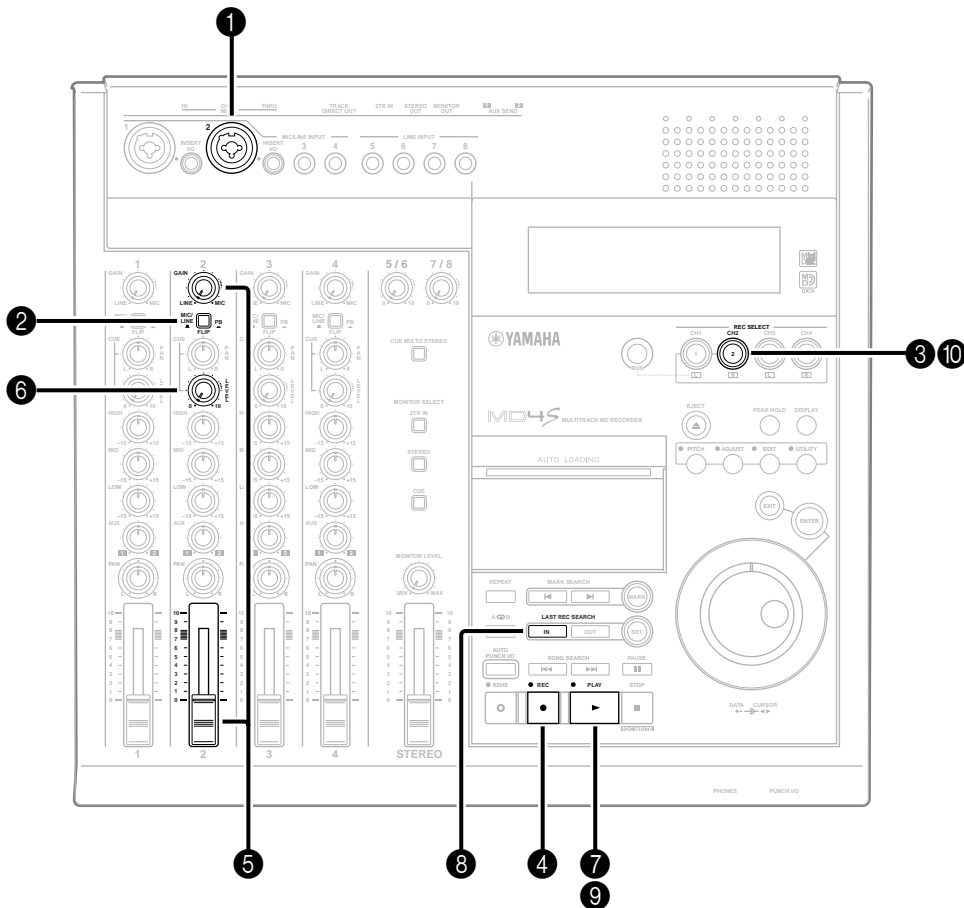
Now that you have finished recording track 1, let's record additional audio sources on other tracks while listening to the playback of this track. The basic procedure is the same as in "Recording the first track."



■ Select the track to record

- 1 Connect the audio source to MIC/LINE INPUT jack 2.
- 2 Set the input channel 2 FLIP switch to the MIC/LINE () position.
At this time, leave the input channel 1 FLIP switch in the MIC/LINE () position.
- 3 Press REC SELECT button 2.
The track 2 track record indicator (DIR) will blink, and track 2 will be ready to record.

Note: You must make sure that the track 1 record indicator (DIR) is dark. If it is blinking, press REC SELECT button 1.

- 4 Press the REC button to enter record-pause mode.
- 5 While watching the track level meter, use the GAIN control and fader of input channel 2 to set the recording level.

■ Simultaneously monitoring the recording source and the track playback

- 6 While playing the audio source that you wish to record, raise the CUE LEVEL control of input channel 2.

Use the CUE LEVEL control of input channel 2 to adjust the monitor level of the signal that will be recorded on track 2. While listening to the sound in your headphones or monitor speakers, adjust the monitor level as desired. If you begin recording now, the playback sound from track 1 will be mixed with the track 2 recording source, and can be monitored via the CUE bus.

■ Start recording

- 7 Press the PLAY button to begin recording. When you finish recording, press the STOP button.

■ Listen to the recording

- 8 Press the LAST REC SEARCH [IN] button to move to the location where you began recording track 2.

If you wish to start listening from the beginning of the song, press the SONG SEARCH [◀◀] button.

- 9 Press the PLAY button to playback, and listen to the recording.

- 10 If you are satisfied with the recording, press the REC SELECT 2 button.

The track 2 track recording indicator (DIR) will go dark.

Go ahead and record the remaining tracks 3 and 4 by overdubbing in the same way.

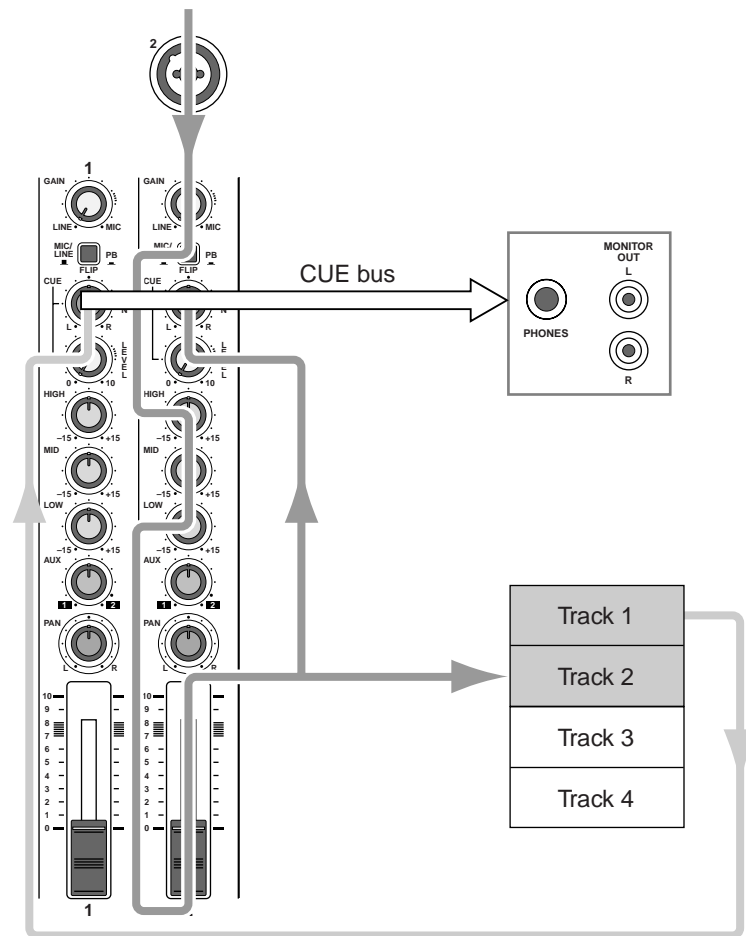

Signal flow during overdubbing

Mixdown

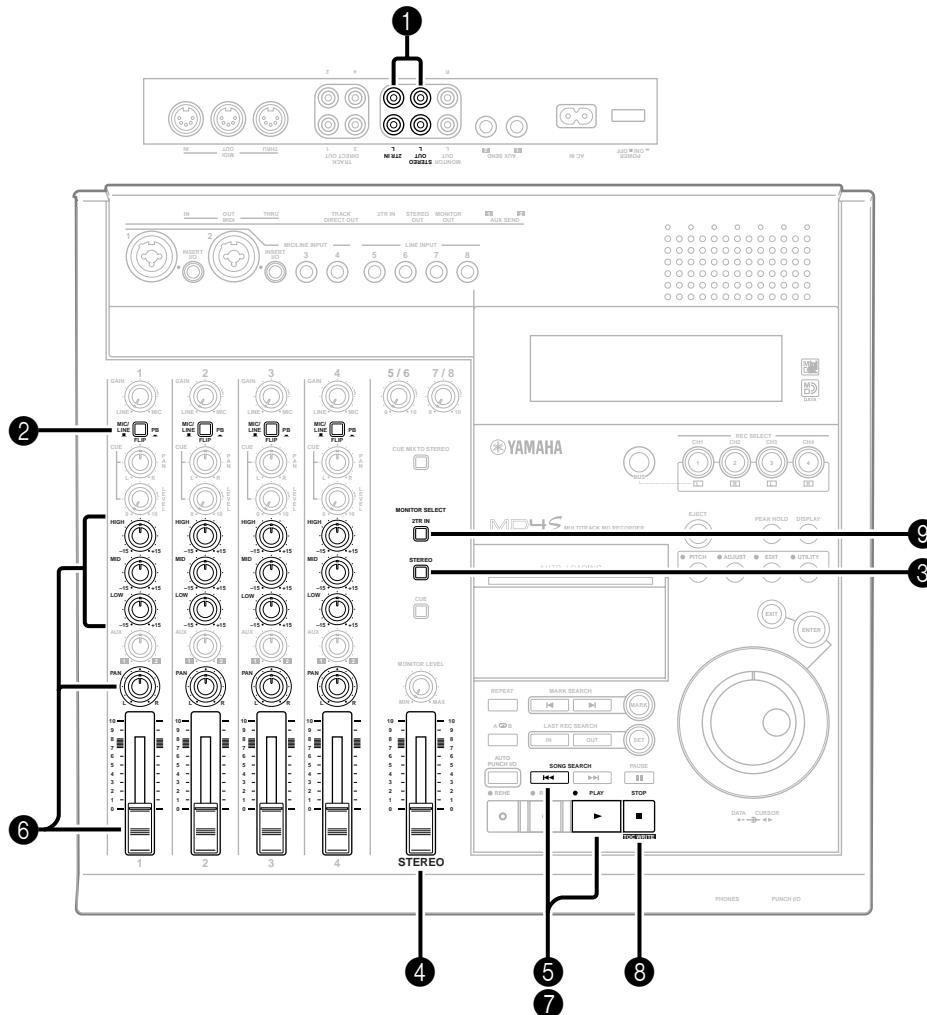

When you have finished recording the four tracks, let's mixdown the recorded tracks to stereo, and record the mix on a master recorder.



■ Connecting a master recorder

- 1 Connect the STEREO OUT jacks of the MD4S to the input jacks of your master recorder. Connect the output jacks of your master recorder to the 2TR IN jacks of the MD4S.

■ Adjust the mix balance of each track

- 2 Set the FLIP switches of input channels 1–4 to the “PB ()” position. When the FLIP switches are set to the “PB ()” position, the playback sound of the corresponding track will be sent to the input channel, allowing you to use the EQ controls to adjust the tone, and use the PAN control to set the stereo (left/right) position. The signals of input channels 1–4 (the

track playback sound) will be mixed in stereo, and output via the ST bus to the STEREO OUT jacks.

- 3 Turn on the MONITOR SELECT STEREO switch. The ST bus will be selected as the signal source for monitoring. Now you can use headphones or monitor speakers connected to the PHONES jack or MONITOR OUT jacks to monitor the same signal as is being output from the STEREO OUT jacks.
- 4 Set the STEREO fader to the 7–8 mark.
- 5 Press the SONG SEARCH [] button to locate to the beginning of the song (the start point), and press the PLAY button to begin playback.

- 6 While listening through the headphones or monitor speakers, use the faders, PAN controls, and EQ controls of input channels 1–4 to adjust the mixdown.

First, use the PAN controls to set the left/right balance. Next, adjust the faders to set the volume balance of each track. At the ideal level, the +12 mark of the stereo level meter should light occasionally. Make fine adjustments to the STEREO fader as necessary. Finally, use the EQ controls as desired to adjust the tone, and re-adjust the volume levels if necessary.

Record to your master recorder

When the mix balance is complete, you can record the result to your master recorder.

- 7 Put your master recorder in record mode, and playback the MD4S song from the beginning.
- 8 When the mixdown is finished, stop the MD4S and the master recorder.

Listen to the master recording

- 9 Press the MONITOR SELECT 2TR IN switch. Now the playback of your master recorder that is being sent to the 2TR IN jacks will be sent to the PHONES jack and the MONITOR OUT jacks.
- 10 Playback your master recorder from the beginning of the song and listen to the master recording. Use the MONITOR LEVEL control to adjust the monitor level.

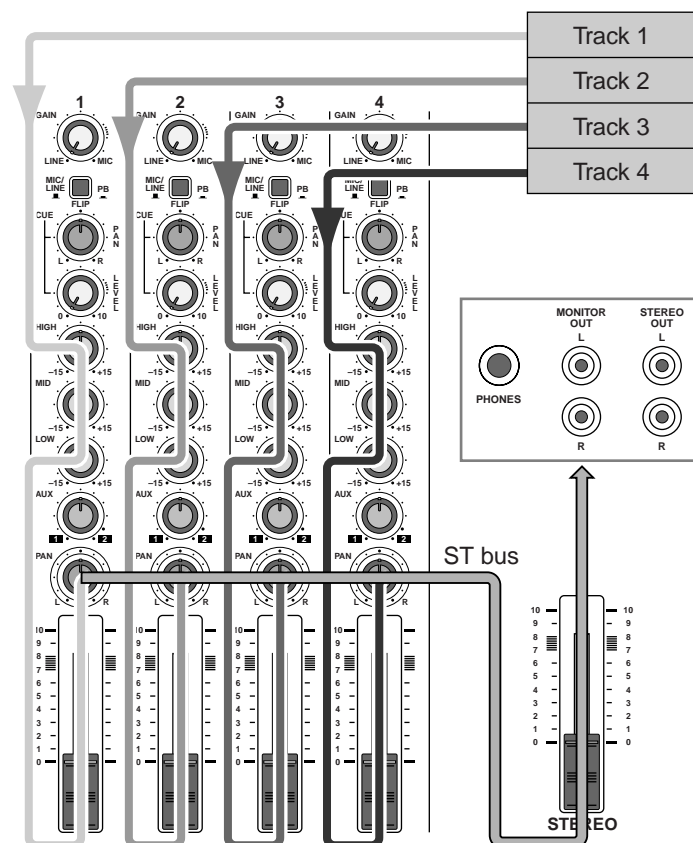

Signal flow during mixdown

After completing the Basic Operation section

In the preceding pages, you have learned the basic procedure for recording four parts, mixing them in stereo, and mixing down to a master recorder. However by taking full advantage of the functionality that the MD4S provides, you can use more sophisticated recording methods and editing techniques. The following page, “Advanced techniques on the MD4S,” introduces the wide variety of functionality provided by the MD4S. You can look through the list to find a topic in which you are especially interested, and continue reading from the appropriate page.

Advanced recording techniques

In this chapter we will introduce more advanced topics, such as more sophisticated recording techniques and editing techniques.

Advanced techniques on the MD4S

In addition to the functionality described on the preceding pages, the MD4S provides the functionality listed below. These functions are actually the core capabilities of the MD4S, and by taking full advantage of them, you will find that the expressive power of the MD4S will take a dramatic leap. Please become familiar with these advanced techniques so that you can enjoy the full potential of the MD4S.

- Record a greater number of parts
 - Mixing multiple channels as you recordpage 36
 - Ping-pong recording.....page 39
 - Adding sounds during mixdownpage 42
- Apply effects while you record/mixdown
 - Applying effects.....page 44
- Re-record over a mistake
 - Punch-in/out.....page 52
- Jump immediately to a specific location in a song
 - Quick search functions.....page 61
- Playback a song repeatedly
- Program the playback order of the songs
 - Various playback functions.....page 66
- Edit a song you recorded
 - Editing functions.....page 73
- Modify the pitch as you record/playback
 - Other functions.....page 84
- Record with a MIDI sequencer
- Control the MD4S from a MIDI sequencer
 - MIDI functionspage 90

Mixing multiple channels as you record

By combining multiple parts into a pair of tracks, you can record more than four parts on the MD4S. For example if you have recorded drums, bass, and rhythm guitar, you can re-record these three parts in stereo onto two tracks, and then record two other parts on the remaining two tracks.

To do this, you will mix the signals of the input channels to the ST bus and record them on either one or two tracks.

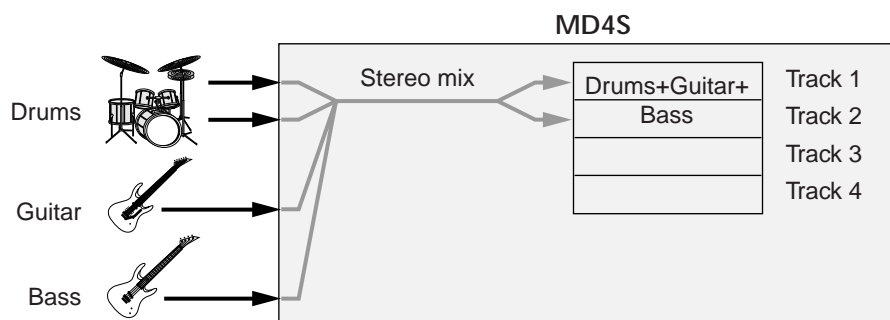

As an example, the following will explain how four audio sources connected to MIC/LINE INPUT jacks 1-4 can be mixed in stereo and recorded onto tracks 1 and 2.

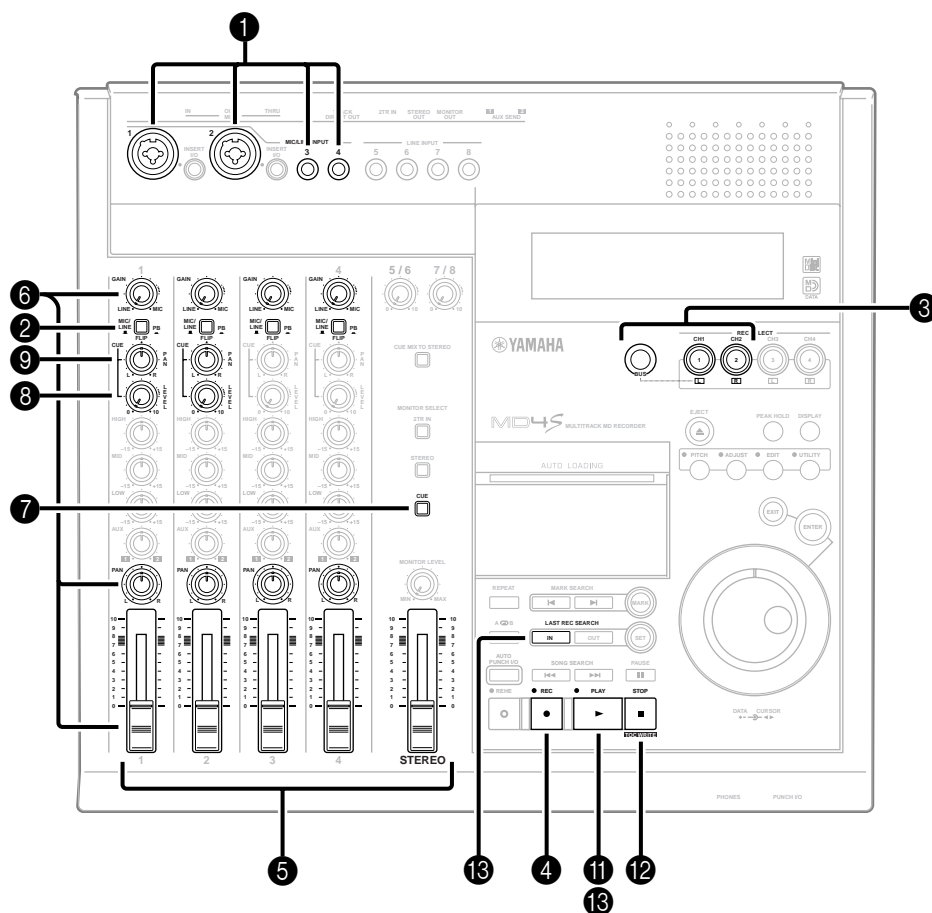

- ① Connect the audio sources to MIC/LINE INPUT jacks 1–4.

If necessary, you can also mix line level devices such as synthesizers connected to LINE INPUT jacks 5 and 6 or 7 and 8.

- ② Set the FLIP switch of input channels 1–4 to “MIC/LINE (■).”
- ③ While holding down the BUS button, press REC SELECT buttons 1 and 2.

The track recording indicators for tracks 1 and 2 (BUS/L,R) will blink.

The signal of an input channel whose FLIP switch is set to “MIC/LINE (■)” will be sent to the ST bus. Also, if the REC SELECT button of a track is pressed while holding down the BUS button, the signal from the ST bus will be selected as the recording source for that track. In this case, the L channel signal of the ST bus will be assigned to track 1, and the R channel signal of the ST bus will be assigned to track 2.

- ④ Press the REC button.
The REC indicator will blink, and the MD4S will be in record-pause mode.
- ⑤ Set the faders of input channels 1–4 and the STEREO fader to the 7–8 mark.
- ⑥ Watch the track level meters, and use the GAIN control and faders of input channels 1–4 and the STEREO fader to adjust the recording level. Use the PAN controls of input channels 1–4 to adjust the stereo position of each audio source.

Tip: You may find it easiest to first adjust the GAIN controls while you play each audio source separately, then use the input channel faders to adjust the volume balance, and finally use the STEREO fader to adjust the overall recording level.

- ⑦ Turn on the MONITOR SELECT CUE switch.
The signal of the CUE bus will be sent to the PHONES jack and the MONITOR OUT jacks.
Turn off the MONITOR SELECT STEREO switch.
- ⑧ Set the CUE LEVEL controls of input channels 1 and 2 to the 7–8 range.
This allows the recording source for tracks 1 and 2 (in this case, the signals from input channels 1–4) be monitored in the CUE bus.

- ⑨ Rotate the CUE PAN controls of input channels 1 and 2 to far left and far right respectively.

This makes the CUE bus signal stereo, and allows you to monitor the same sound image as is being recorded.

Note: In this situation, the CUE bus and the ST bus have the same signal content. Be aware that if the MONITOR SELECT CUE switch and the STEREO switch are both on, the sound being monitored in the PHONES jack or the MONITOR OUT jacks will appear unnatural.

- ⑩ Listen to the headphones or monitor speakers, and adjust the volume and pan of each input channel. As necessary, use the EQ controls to adjust the tone.
- ⑪ Press the PLAY button to begin recording.
The track recording indicators (BUS) of tracks 1 and 2 will change to steadily lit.
- ⑫ When you finish recording, press the STOP button.
The TOC will be automatically updated, and the track recording indicators (BUS) of tracks 1 and 2 will change to blinking.
- ⑬ Press the LAST REC SEARCH [IN] button to locate to the point at which recording began, and press the PLAY button to hear the recording.
If you are satisfied with the recording, press REC SELECT buttons 1 and 2. The track recording indicators (BUS/L,R) will go dark.

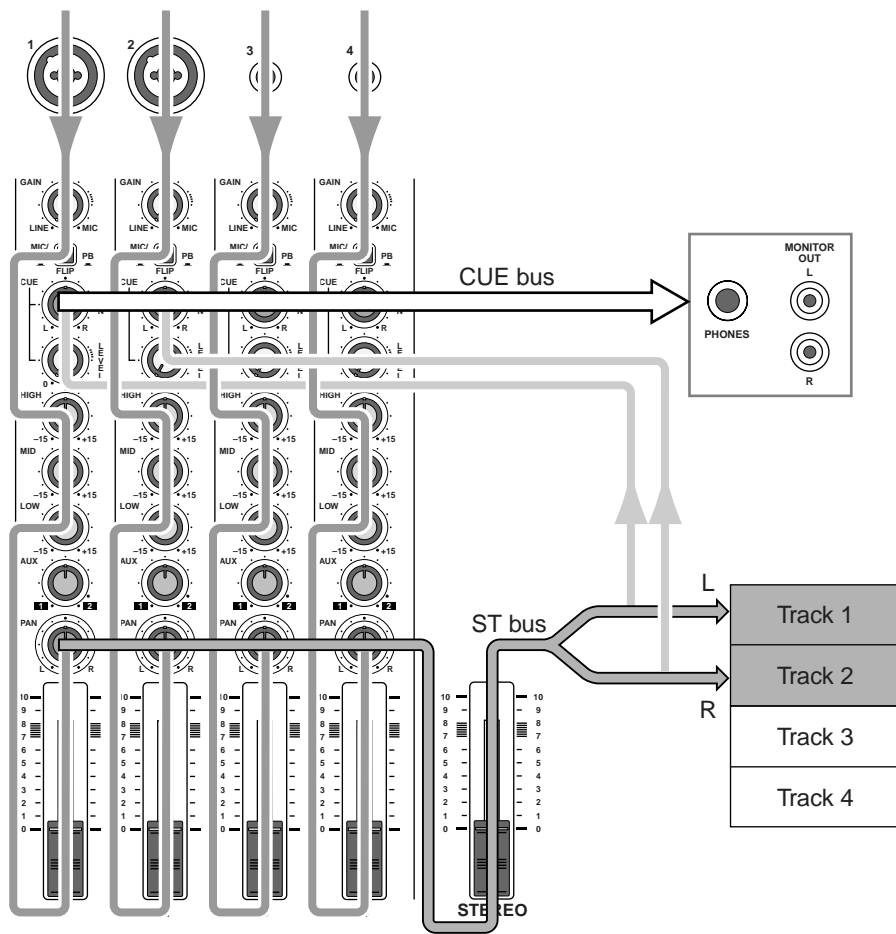

Signal flow when mixing multiple channels

Ping-pong recording

The process of mixing two or more previously-recorded tracks and re-recording them onto one or two tracks is called “ping-pong recording.” By ping-ponging, you can free up other tracks to record additional parts, so this is a useful technique when you wish to record a larger number of parts than you have actual tracks. Since the MD4S records signals digitally, it is able to playback a track while recording onto the same track. Thus, while a conventional cassette-tape type MTR needs one or two vacant tracks in order to ping-pong, the MD4S allows you to ping-pong even if there are no unused tracks.

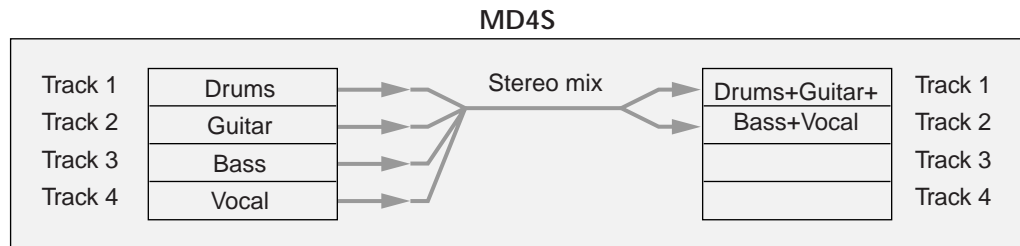

The following diagram shows the process of mixing four recorded tracks into a stereo pair, and continuing to overdub while ping-pong recording additional tracks.

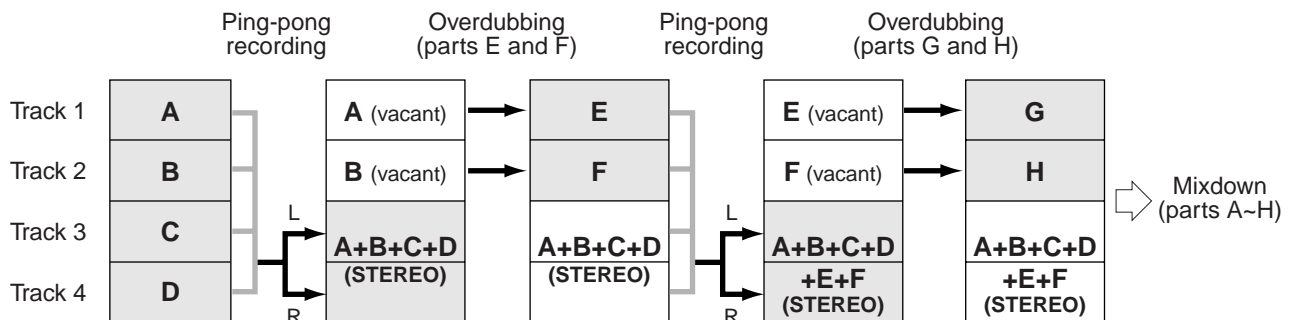

Note: Since the MD4S records data in digital form, repeated ping-pong recording as shown above will not impair the audio quality. However, please be aware that since the MD4S’s mixer section is analog, repeated ping-pong recording will result in a very small decrease in audio quality (although compared to the result of ping-pong recording on a tape MTR, this loss will be virtually undetectable).

Tip: If you ping-pong record tracks 1–4 to tracks 3 and 4 as shown above, the content that had been recorded on tracks 3 and 4 will be erased. Before you ping-pong record, we recommend that you copy the song to backup the original. (See “*Copying/converting a song (Song Copy)*” on page 76 for more information.)

In the following, we will give an example of mixing previously-recorded tracks 1–4 into a stereo pair, and ping-pong recording them to tracks 3 and 4.

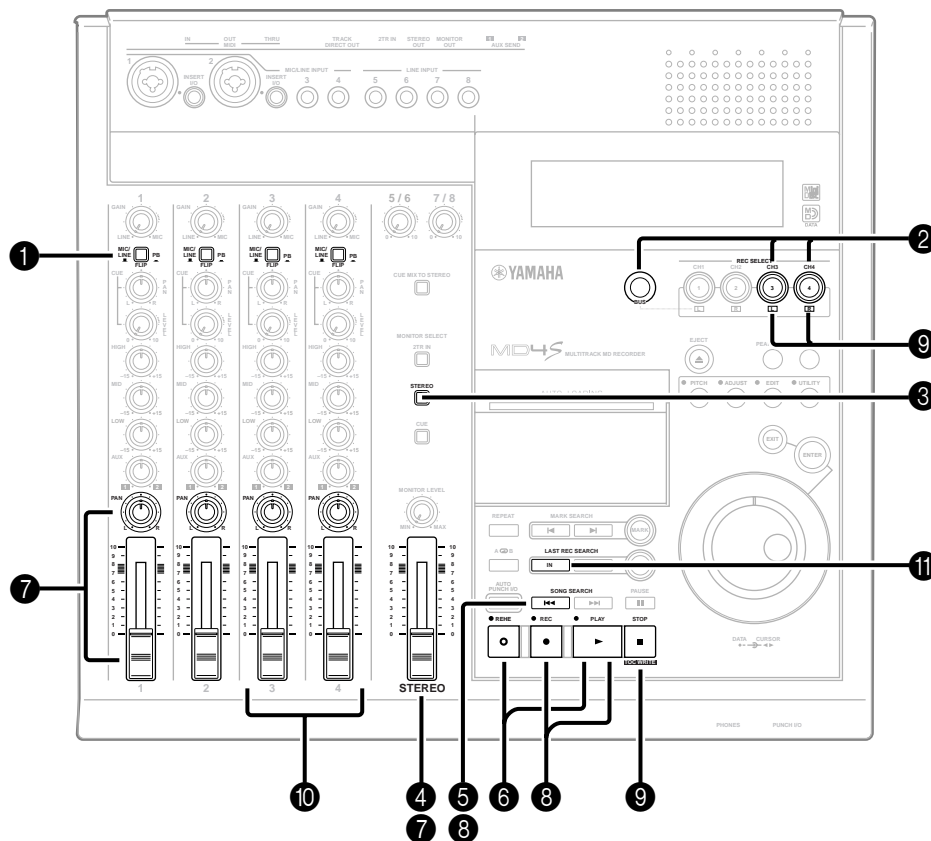

- 1 Set the FLIP switches of input channels 1–4 to “PB (—).”

The playback sound of tracks 1–4 will be sent via the input channels to the ST bus.

Tip: If you use LINE INPUT jacks 5–8, the audio sources connected to LINE INPUT jacks 5–8 can be added to tracks 1–4 as you ping-pong record. The input level of LINE INPUT jacks 5–8 can be adjusted by the LEVEL controls 5/6 and 7/8.

- 2 While holding down the BUS button, press REC SELECT buttons 3 and 4.
The ST bus will be selected as the recording source for tracks 3 and 4, and the track record indicators (BUS/L, R) will blink.
Make sure that the track record indicators for tracks 1 and 2 are dark.
- 3 Turn on the MONITOR SELECT STEREO switch.
The ST bus will be selected as the signal source for

monitoring, allowing you to monitor the playback sound of tracks 1–4.

Make sure that the MONITOR SELECT CUE switch is off.

- 4 Set the STEREO fader in the 7–8 range.
- 5 Press the SONG SEARCH [◀◀] button to locate to the beginning of the song.
- 6 Press the REHE button, and then press the PLAY button to begin rehearsing the ping-pong recording.
- 7 While listening to your monitoring headphones or monitor speakers, use the faders and PAN controls of input channels 1–4 to adjust the mix balance of tracks 1–4. As necessary, use the EQ controls to adjust the tone. When you finish adjusting the mix balance, watch the track level meters of tracks 3 and 4 as you adjust the STEREO fader to set the recording level. (At the ideal level, the –3 segment of the meter will light at the peaks.)

- 8 When you have finished adjusting the mix balance and recording level, press the SONG SEARCH [◀◀] button to locate to the beginning of the song, and then press the REC button and PLAY button to begin ping-pong recording.
- 9 When ping-pong recording ends, press the STOP button, and then press REC SELECT buttons 3 and 4.
- 10 Set the faders of input channels 3 and 4 in the 7–8 range, and rotate the PAN controls to far left and far right respectively. Set all EQ controls to the 12 o'clock position (flat). At this time, lower the faders of input channels 1 and 2 to zero.
- 11 Press the LAST REC SEARCH [IN] button to locate to the point at which ping-pong recording began, and while using the MONITOR LEVEL control to adjust the monitor level, listen to the recorded content of tracks 3 and 4.

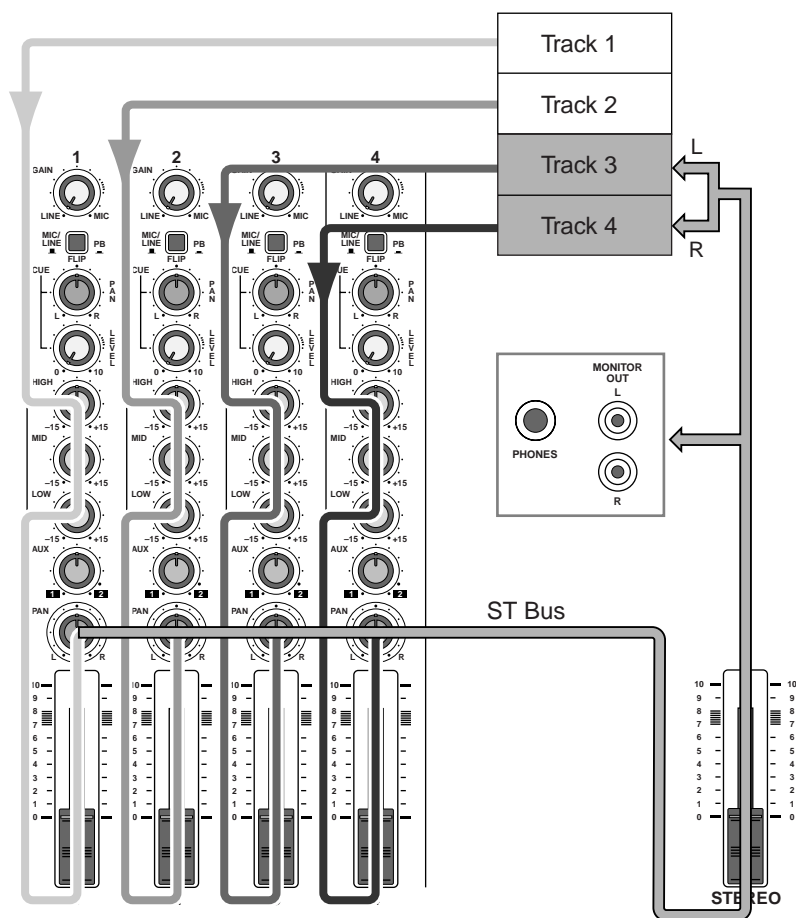

Signal flow for ping-pong recording

Adding sounds during mixdown

The mixer section of the MD4S features an “in-line” design that can simultaneously handle both the input signal from the MIC/LINE INPUT jack and the playback sound from the disk. For example, this allows you to add external input signals during mixdown. This is convenient, for example, when you wish to layer some sound effects onto the introduction of a song that you completed on the MD4S.

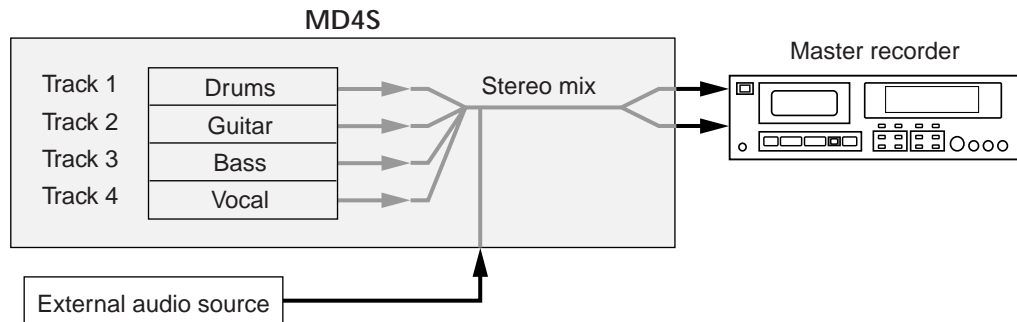

In the following, we will give an example of how audio sources connected to MIC/LINE INPUT jacks 1 and 2 can be added during mixdown.

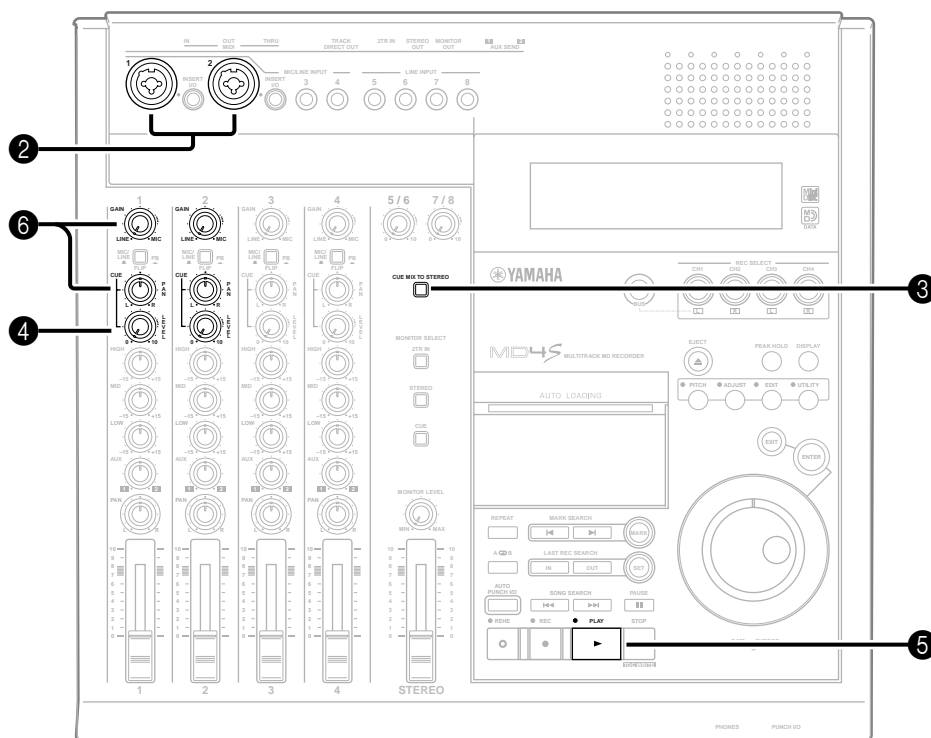

- 1 Make preparations for mixdown.
See “*Mixdown*” on page 32, adjust the mix balance of each track, and complete the steps up until you are ready to mixdown (steps 1–6).
- 2 Connect your audio sources to MIC/LINE INPUT jacks 1 and 2.
When the FLIP switch of the input channel is in

the “PB (—)” position, the tape playback sound will be set to the ST bus, and the input signal from the MIC/LINE INPUT jack will be sent via the CUE PAN/LEVEL control to the CUE bus. In this case, the input signals from MIC/LINE INPUT jacks 1 and 2 will be sent via the CUE PAN/LEVEL controls of input channels 1 and 2 to the CUE bus.

- 3 Turn on the CUE MIX TO STEREO switch.
The cue mix function will be turned on, and the CUE MIX indicator in the display will light. With this setting, the signal of the CUE bus (the MIC/LINE INPUT jack input signal) will be mixed into the ST bus.
- 4 Set the CUE LEVEL controls of input channels 1 and 2 in the 7–8 range.
- 5 Press the PLAY button to begin playback.
If the MONITOR SELECT STEREO switch is on, you will be able to hear the track playback in your headphones or monitor speakers.
- 6 Play the audio sources that are connected to MIC/LINE INPUT jacks 1 and 2, and use the GAIN controls of input channels 1 and 2 to adjust the input level.
Use the stereo level meter to check the input levels together with the track playback sound. If the level is too high even when the GAIN control is rotated all the way to the LINE position, lower the CUE

LEVEL control. If necessary, you can use the CUE PAN controls to adjust the stereo position. (If you are adding a stereo source, set the CUE PAN controls of input channels 1 and 2 to far left and far right respectively.)

- 7 After you have adjusted the input signal levels from MIC/LINE INPUT jacks 1 and 2, start recording on your master recorder, and playback the MD4S from the beginning of the song.

When recording is completed, playback the master recorder to hear the recorded result.

Tip: The input signals from LINE INPUT jacks 5–8 can be added to the mix during mixdown. However since LINE INPUT jacks 5/6 and 7/8 are stereo pairs, LINE INPUT jacks 5 and 7 will be mixed directly to the L channel of the ST bus, and LINE INPUT jacks 6 and 8 will be mixed directly to the R channel of the ST bus. If you wish to use microphones or to adjust the pan, you should use the MIC/LINE INPUT jacks.

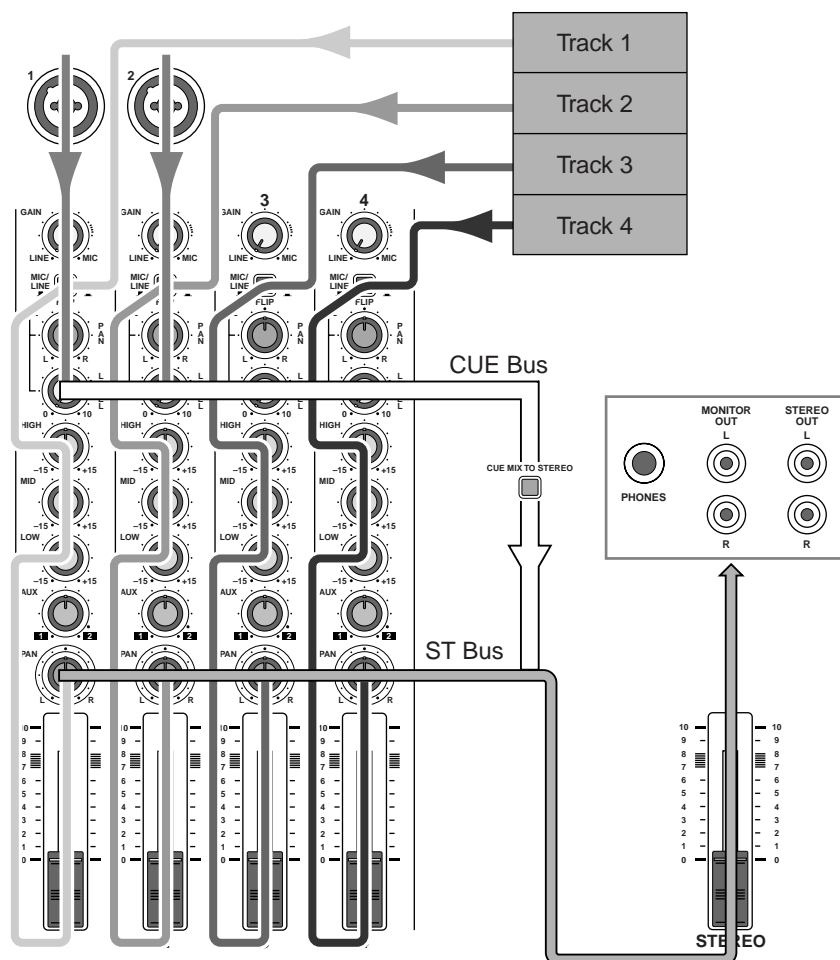

Signal flow when adding external signals during mixdown

Applying effects

Here we will explain how external effects can be applied as you record tracks or during mix-down. If you wish to apply effects to the input signal of an input channel or to the playback sound of a track, two methods are available: using the INSERT I/O jack or using the AUX SEND jack.

Using the INSERT I/O jacks

Input channels 1 and 2 of the MD4S provide INSERT I/O jacks for inserting external effect processors. By using these jacks, you can apply an effect only to a specific channel/track as you record a track or while you mixdown. Normally, the technique of applying an effect via the INSERT I/O jack is used for effects which affect the dynamics or tone of the original sound (e.g., compressor, limiter, noise gate, equalizer etc.).

Applying an effect to a specific track as you record

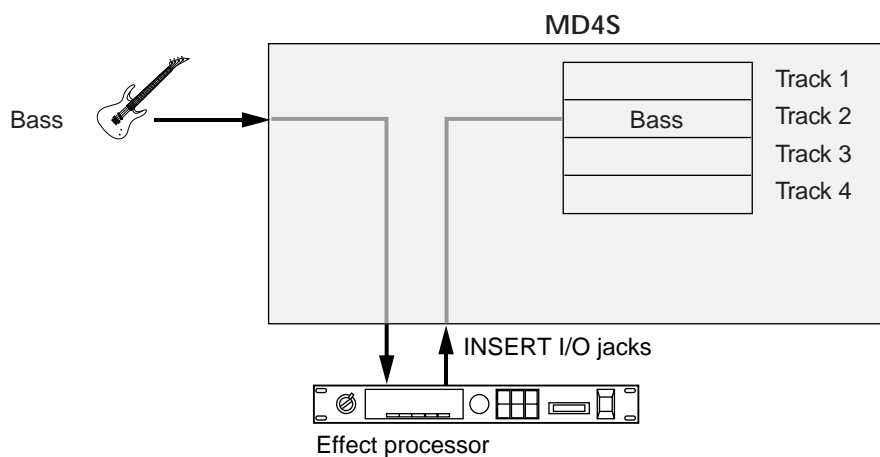

The INSERT I/O jacks accommodate TRS (tip, ring, sleeve) phone plugs. The signal of the input channel is sent from the tip of the INSERT I/O jack to the external effect unit, and the signal that has been processed by the external effect unit is sent via the ring of the INSERT I/O jack back into the input channel.

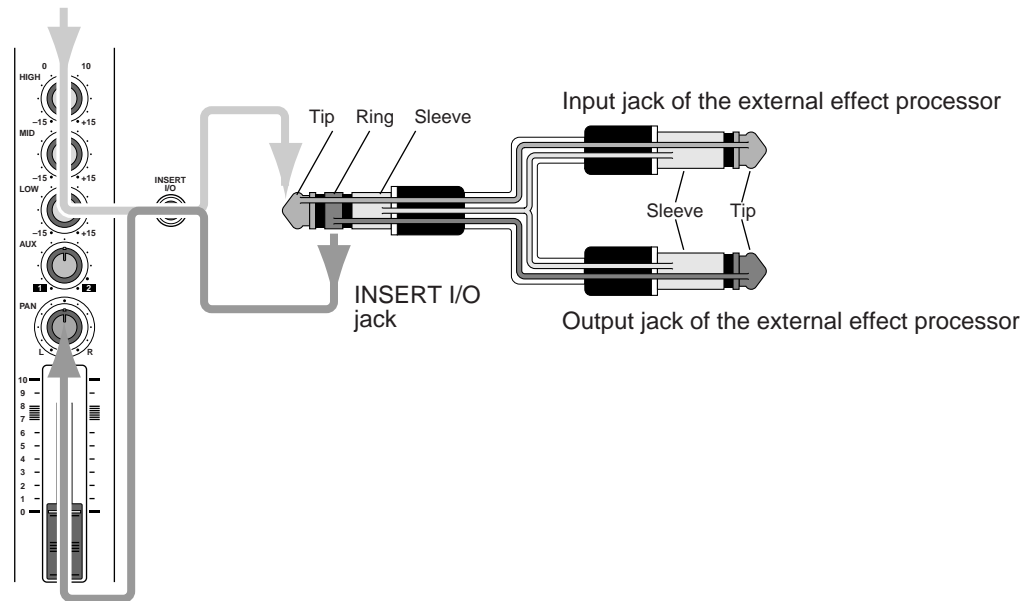

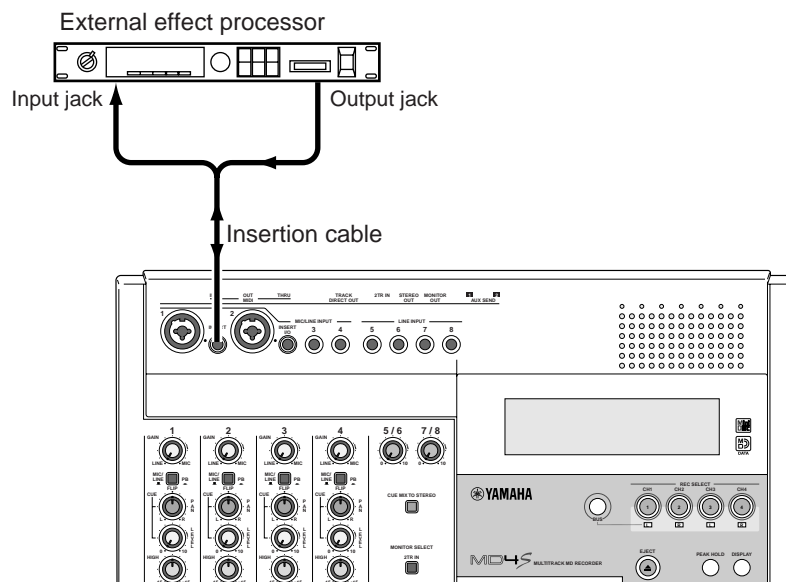

Signal flow through the INSERT I/O jack and the insertion cable

In order to use the INSERT I/O jack to apply an external effect, you will need a special insertion cable as shown in the above diagram. Use the insertion cable to connect the external effect processor as shown in the following diagram.



External effect connections when using an insertion cable

After making these connections, you can record tracks or perform a mixdown in the same way as usual. When the FLIP switch is in the “MIC/LINE ()” position, the effect will be applied to the input signal from MIC/LINE INPUT jack 1 or 2. When the FLIP switch is in the “PB ()” position, the effect will be applied to the playback sound of track 1 or 2.

Using the AUX SEND jacks

When the AUX SEND jacks of the MD4S are used, a single external effect processor can be used simultaneously by two or more input channels. For example when you are re-recording several channels to two tracks or when mixing down, you can use this method to apply an effect such as delay or reverb while adjusting the depth of the effect independently for each channel (track).

Applying an effect with a different depth for each track as you mixdown

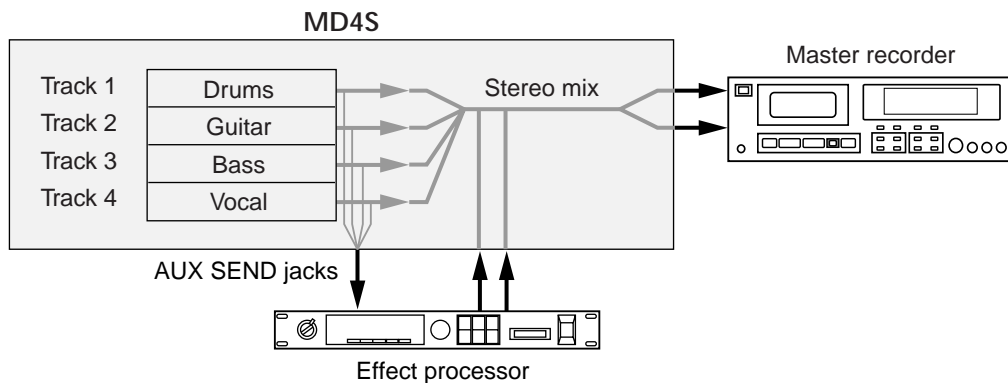

When using the AUX SEND jacks to connect an external effect processor, connect the AUX SEND jacks 1 or 2 to the input jacks of the external effect processor, and connect the output jacks of the effect processor to LINE INPUT jacks 5 and 6 or 7 and 8.

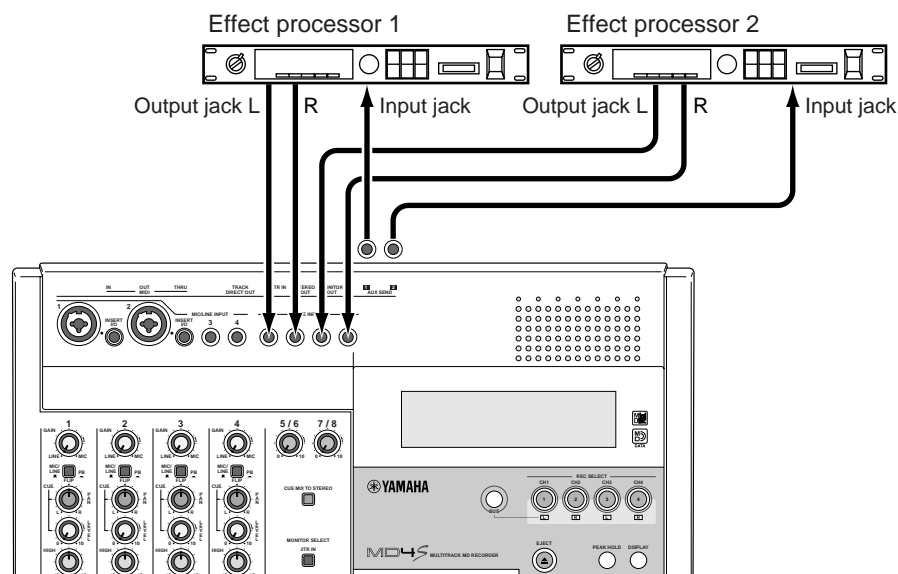

External effect connections when using the AUX SEND jacks

With this setup, rotating the AUX controls of the input channels toward the 1 or 2 position will mix the signals from the input channels (in mono) and send them via the AUX SEND 1 or 2 jack to the external effect processor. The output signals from the effect processor will be mixed via the LINE INPUT jacks 5 and 6 (or 7 and 8) into the ST bus. Normally, the technique of using the AUX SEND jacks to apply effects is used for effects in which the original sound is mixed with the processed sound (e.g., delay, reverb, chorus etc.). In general, you should make settings on the effect processor so that it will output only the processed sound, and use the MD4S mixer to adjust the mix of the original sound (the signal sent from the input channel to the ST bus) and the effect sound (the signal sent via LINE INPUT jacks 5–8 to the ST bus).

Applying effects during mixdown

Applying an effect such as reverb to each track during a mixdown is an example of a situation in which you would connect the external effect processor to the AUX SEND jack. In this case, you can use the AUX control of each input channel to adjust the effect depth for each track.

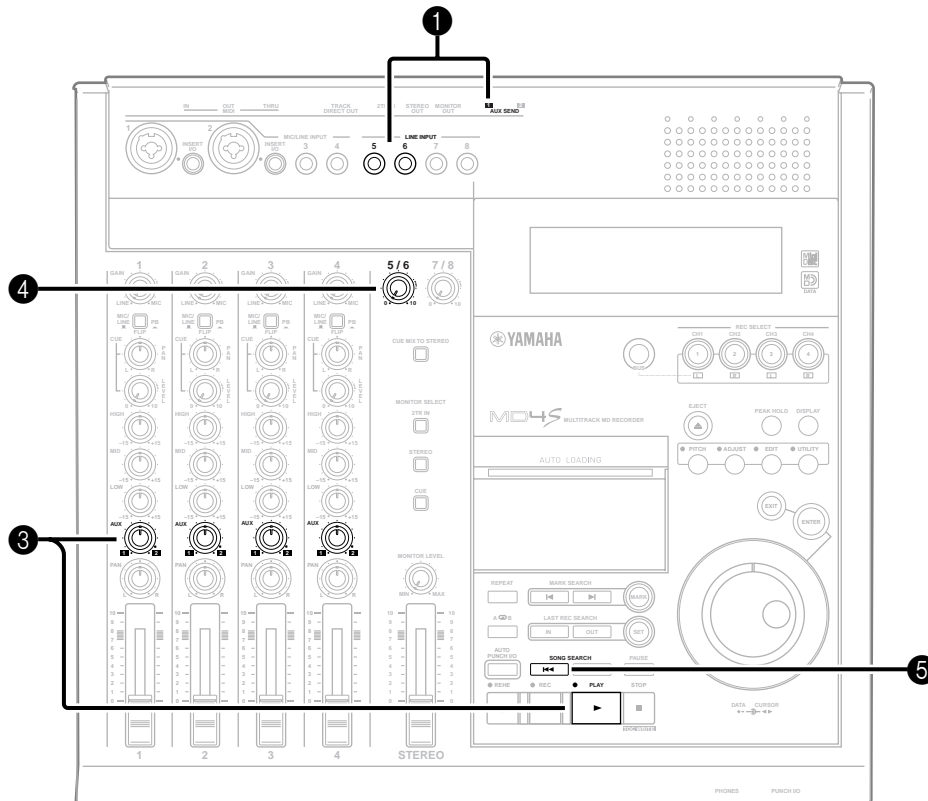

- 1** Connect the AUX SEND 1 jack to the input jack of your effect processor, and connect the output jacks of the effect processor to LINE INPUT jacks 5 and 6. Make settings on the effect processor so that its output jacks will output only the effect sound.
- 2** Prepare for mixdown.
As described in “Mixdown” (page 32), adjust the mix balance of each track, and perform the steps leading up to mixdown (steps **1**–**6**).
- 3** Press the PLAY button to playback the song, and for each input channel to which you wish to apply the effect, rotate the AUX control toward the “1” position.
The signals from input channels 1–4 (the playback of tracks 1–4) will be sent to the external effect processor connected to the AUX SEND 1 jack. Adjust the input level of the effect processor if necessary.
- 4** Raise level control 5/6.
The effect sound processed by the external effect processor will be mixed into the ST bus. Raising the level control will increase the overall effect.
- 5** When you are finished adjusting the effect depth, press the SONG SEARCH [I◀◀] button to locate to the beginning of the song, and begin the mixdown.

Applying an effect during ping-pong recording

By using the AUX SEND jacks you can apply spatial-type effects such as reverb or chorus during ping-pong recording as well. This technique is particularly useful when you wish to ping-pong in stereo down to two tracks. The following will explain how to apply an effect to the playback of tracks 1–4 as you ping-pong them in stereo to tracks 3 and 4.

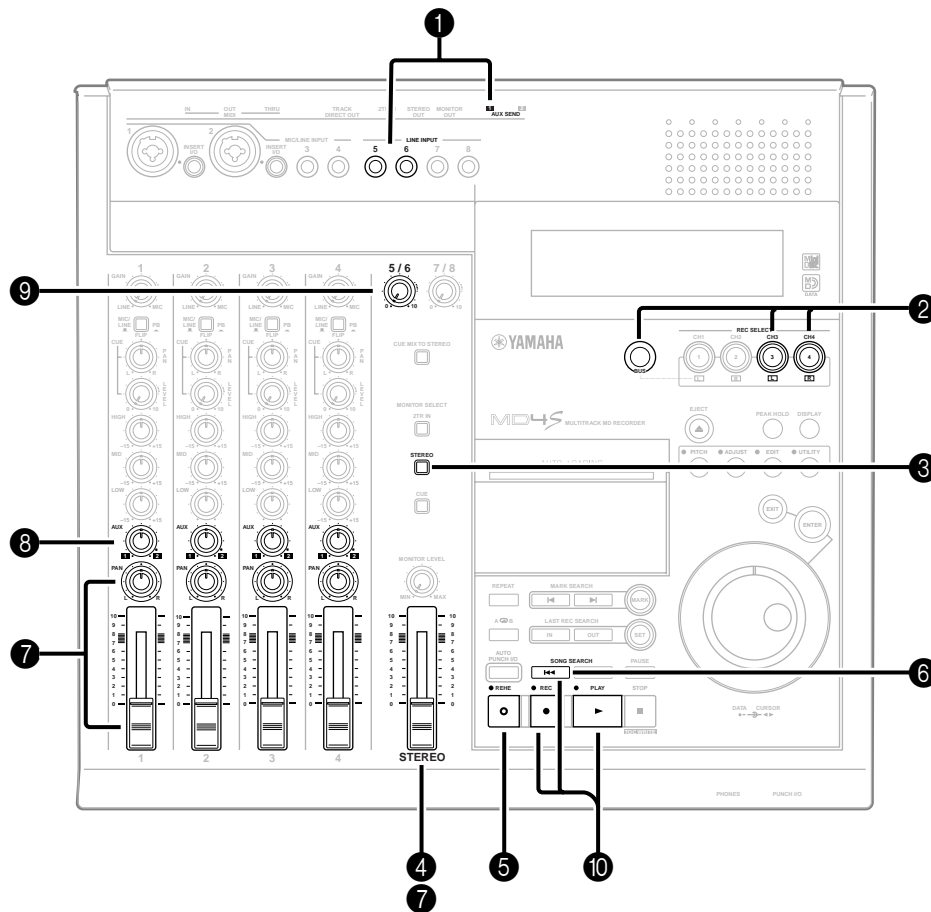

- 1 Connect the AUX SEND 1 jack to the input jack of your external effect processor, and connect the output jacks of the effect processor to the LINE INPUT jacks 5 and 6. Make settings on your effect processor so that only the processed sound is output.
- 2 Hold down the BUS button, and press REC SELECT buttons 3 and 4.
The track record indicators (BUS/L, R) will blink. Make sure that the track record indicators for tracks 1 and 2 are dark.
- 3 Turn on the MONITOR SELECT STEREO switch.
Make sure that the MONITOR SELECT CUE switch is off.
- 4 Set the STEREO fader in the 7–8 range.
- 5 Press the REHE button.
- 6 Press the SONG SEARCH [⏮] button to locate to the beginning of the song, and press the PLAY button to begin rehearsal.
- 7 While listening to your monitor headphones or monitor speakers, use the input channel 1–4 faders and PAN controls to adjust the mix balance of tracks 1–4. If necessary, use the EQ controls to adjust the tone.
When you have finished adjusting the mix balance, watch the track 3 and 4 track level meters as you make fine adjustments to the STEREO fader to set the recording level. (At the ideal level, the –3 segment will light when peaks occur.)

- 8 On the input channels to which you wish to apply the effect, rotate the AUX control toward the "1" position.
The signals from the input channels will be mixed in monaural according to the position of each AUX control, and will be sent via the AUX SEND 1 jack to the external effect processor.
- 9 Raise level control 5/6.
The effect sound from the external effect processor will be sent via LINE INPUT jacks 5 and 6 and mixed into the ST bus.
- 10 When you have finished adjusting the mix balance, recording level, and effect amount, press the SONG SEARCH [⏮] button to locate to the beginning of the song, and then press the REC button and PLAY button to start ping-pong recording.

Applying an effect only to the monitor signal

By making skillful use of direct recording and the MONITOR SELECT switches, you can apply effects only to the monitor signal so that tracks are recorded without effects. For example when recording vocals, you can let the vocalist monitor their voice with reverb, but record the vocal on the track without effects. The following will explain the example of monitoring tracks 1–3 while you record a vocal on track 4.

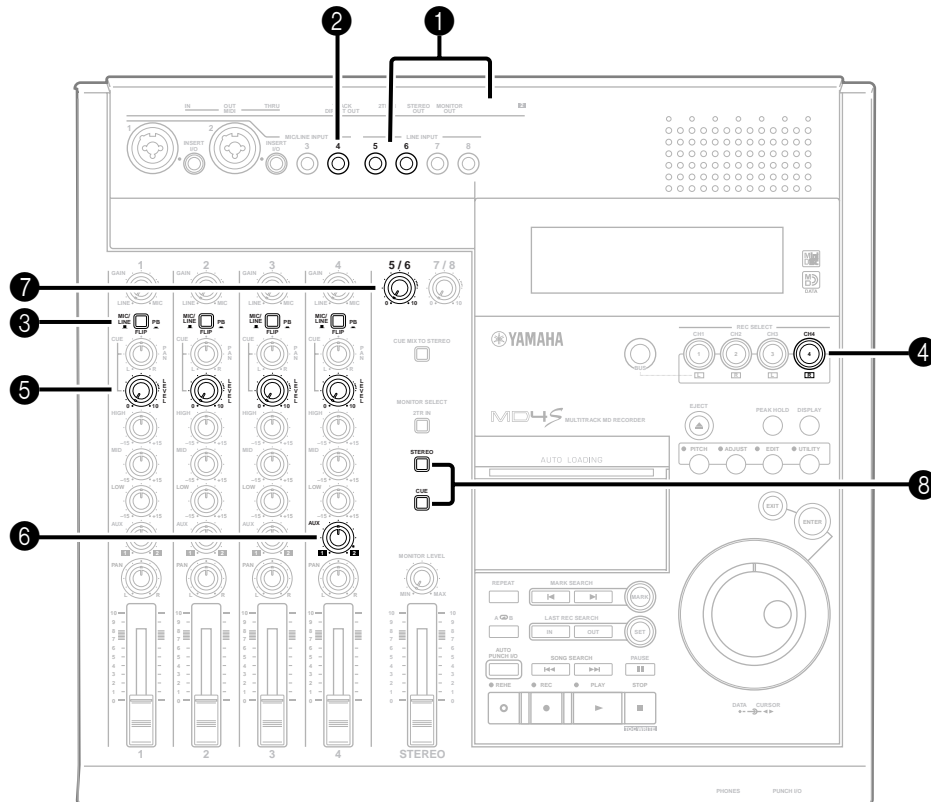

- 1** Connect the AUX SEND 1 jack to the input jack of your external effect processor, and connect the output jacks of the effect processor to the LINE input jacks 5 and 6. Make settings on your effect processor so that it will output only the processed sound.
- 2** Connect the vocal mic to MIC/LINE INPUT jack 4.
- 3** Set the FLIP switch of input channels 1–4 to “MIC/LINE (■).”
- 4** Press REC SELECT button 4. The track record indicator (DIR 4) will blink, and the vocal will be recorded directly to track 4. Make sure that the other track record indicators are dark.
- 5** Raise the CUE LEVEL controls of input channels 1–4. The recording source of track 4 (vocal without the effect) and the playback of tracks 1–3 can now be monitored via the CUE bus.
- 6** Rotate the AUX control of input channel 4 toward the “1” position. The vocal signal will be sent to the effect processor connected to the AUX SEND 1 jack.
- 7** Raise level control 5/6. Only the vocal effect sound will be sent to the ST bus.
- 8** Turn on the MONITOR SELECT CUE switch and MONITOR SELECT STEREO switch. With these settings, the signal of the CUE bus (the playback of tracks 1–3 and the unprocessed vocal) and the signal of the ST bus (vocal effect sound) can be monitored together.

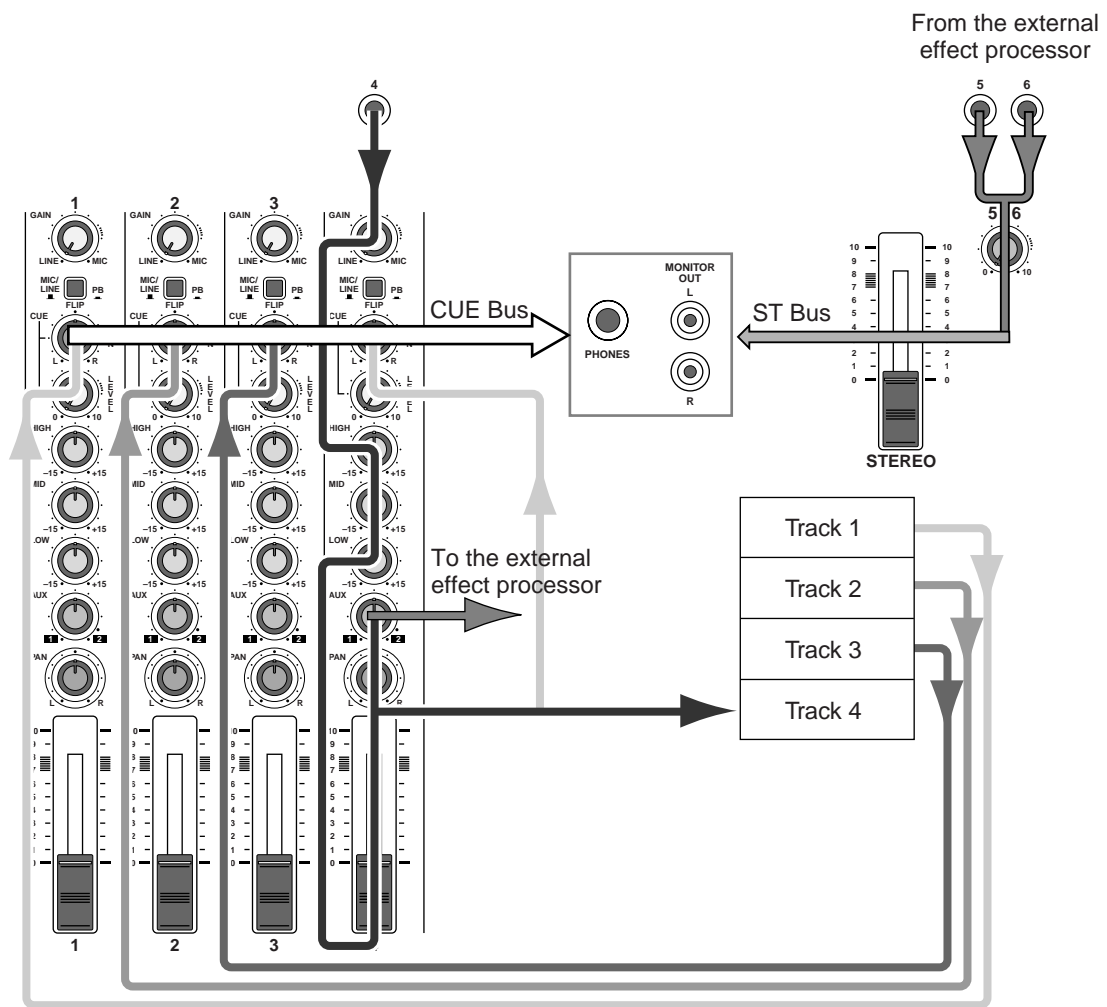

Signal flow when applying an effect only to the monitor signal

Punch-in/out

This section explains techniques using punch-in/out. Punch-in/out is a function that allows you to re-record just a specific portion of a previously-recorded track. While listening to the playback of a track, you can begin recording (punch-in) at the desired location, play the portion that you wish to re-record, and then stop recording (punch-out), thus re-recording only the portion where a mistake occurred.

The MD4S allows you to use a variety of punch-in/out techniques. You can use “manual punch-in/out” by pressing the REC button or REC SELECT buttons or an optional FC5 foot switch. Alternatively, you can use “auto punch-in/out” that will automatically perform the operation at the previously-specified locations. You can also use the rehearsal function to practice the punch-in/out for any of these techniques.

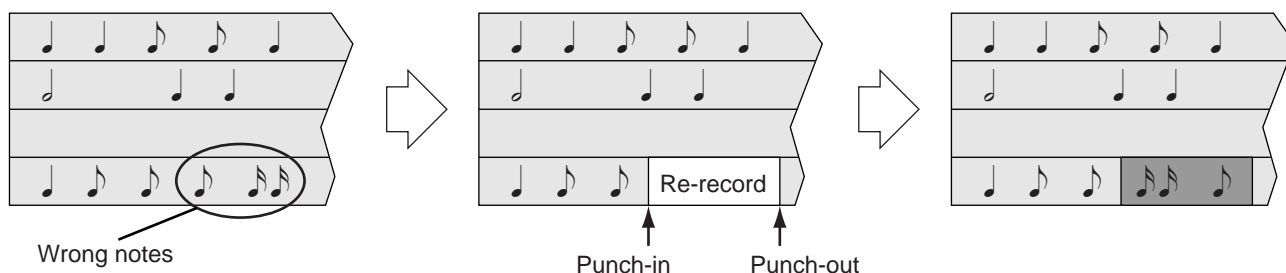

Manual punch-in/out

Here's how to use the MD4S's REC button and REC SELECT buttons (or an optional FC5 foot switch) to perform manual punch-in/out.

■ Punch-in/out using the REC button

1. Connect the audio source to the MD4S.
2. Set the FLIP switches of input channels 1–4 to “MIC/LINE (■).”
3. Turn on the MONITOR SELECT CUE switch.
When performing punch-in/out, you will need to monitor the track playback up to the point where you punch-in, and monitor the recording source after punch-in. For this reason when you use punch-in/out, you must always turn on the MONITOR SELECT CUE switch to monitor the CUE bus. Also, you should turn off the MONITOR SELECT STEREO switch.
4. Locate to a point slightly earlier than where you wish to punch-in.
By operating the CURSOR shuttle during playback, you can cue (play forward) or review (play backward) at a variety of speeds. (See “*Shuttle playback functions*” on page 66.) For other locate methods, refer to “Other functions” on page 84.
5. Press one of the REC SELECT buttons (or the BUS button + one of the REC SELECT buttons) to select the track on which you wish to record.
The track record indicator for the selected track will blink.
6. Press the REC button and adjust the recording level.
The REC indicator will blink, and the MD4S will be in record-pause mode.

7. When you have finished adjusting the recording level, press the STOP button to temporarily cancel record-pause mode.
8. Press the PLAY button to begin playback.
9. At the location where you wish to punch-in, press the REC button. The REC indicator will light, and from this point recording will begin for the track that was selected by the REC SELECT buttons. At this time, the monitor signal of the track that was selected for recording will change from the track playback to the recording source.

Tip: By pressing the REHE button instead of the REC button, you can rehearse the punch-in/out. In this case, the monitor signal of the track that was selected for recording will change from the track playback to the recording source, but the recording source will not actually be recorded on the track. This is convenient when you wish to practice the timing at which you punch-in/out, or to check the volume difference between the track playback and the recording source.

10. At the point where you wish to punch-out, press the PLAY button. The REC indicator will go dark, recording will end, and normal playback will resume. The monitor signal of the track selected for recording will return to the track playback.

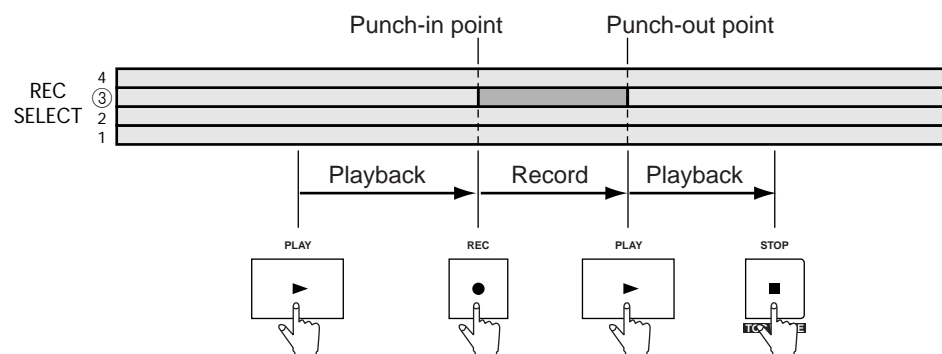

■ Punch-in/out using REC SELECT

1. Make preparations for manual punch-in/out. Use steps 1–6 of “Punch-in/out using the REC button” on page 52 to prepare for manual punch-in/out.
2. For the recording track that you selected in step 1, press the REC SELECT button once again so that all track record indicators are dark.
3. Press the PLAY button. With the REC indicator still blinking, the track will playback. Recording will not occur at this time because the recording track is not selected.
4. When you arrive at the location where you wish to punch-in, press the REC SELECT button for the track that you wish to record. (Alternatively, you can hold down the BUS button and press the REC SELECT button.) The REC indicator will change to be steadily lit, and recording will begin on the track selected by the REC SELECT buttons.

- When you arrive at the location where you wish to punch-out, press the REC SELECT button once again.

The track record indicator will go dark, recording will end, and playback will resume.

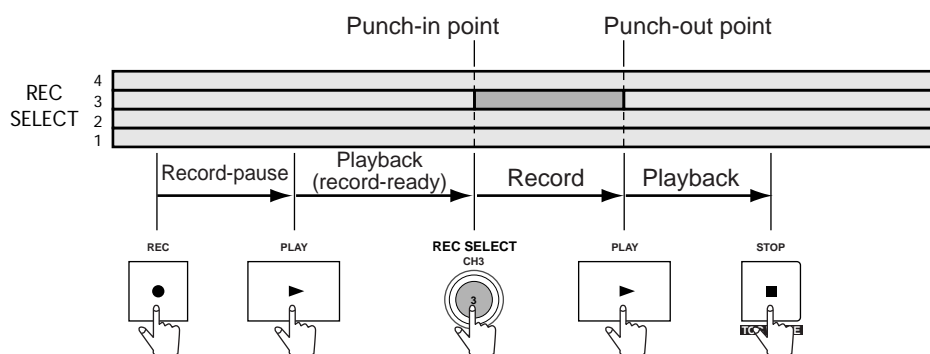

■ Punch-in/out using a foot switch

If you connect a separately sold FC5 foot switch to the PUNCH I/O jack located on the front panel of the MD4S, you can punch-in/out using the foot switch. This method is convenient when the same person is both playing an instrument and operating the MD4S to punch-in/out.

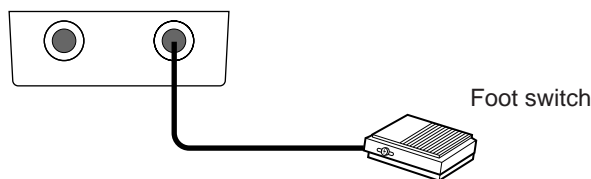

Foot switch connections

- Make preparations for manual punch-in/out.
Follow steps 1–6 of “Punch-in/out using the REC button” on page 52 to prepare for manual punch-in/out.
- Press the foot switch.
The REC indicator will continue blinking, and track playback will begin.
- Press the foot switch at the location where you wish to punch-in.
The REC indicator and the track record indicator will change to steadily lit, and recording will begin on the track selected by the REC SELECT button.
- Press the foot switch at the location where you wish to punch-out.
The REC indicator will go dark. Recording will end and normal playback will resume.
- Press the foot switch once again to enter pause mode.
Press the STOP button to stop.

Note: The PLAY button is not used when using a foot switch to punch-in/out. Be aware that if you inadvertently press the PLAY button from record-pause mode, recording will begin immediately.

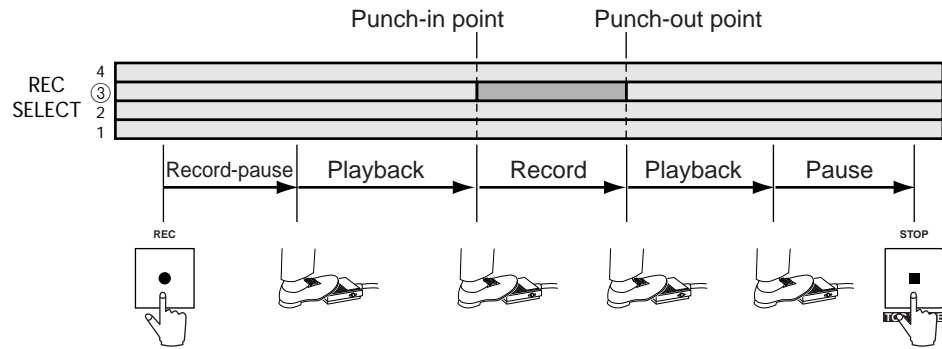

Auto punch-in/out

Here we will explain how to use the auto punch-in/out function, which performs the punch-in and punch-out operations automatically. This function allows you to repeatedly perform punch-in/out with single-frame accuracy (11.6 ms).

■ Specify the auto punch-in/out points

Before you begin auto punch-in/out, you must set the “auto punch-in point” at which punch-in will occur, and the “auto punch-out point” at which punch-out will occur. The locations at which recording/rehearsal was last started (last record in point) and ended (last record out point) will be used as the auto punch-in/out points.

1. At the location where you wish to auto punch-in, hold down the SET button and press the LAST REC SEARCH [IN] button.
The display will indicate “MARK IN,” and this location will be specified as the auto punch-in point.
2. At the location where you wish to auto punch-out, hold down the SET button and press the LAST REC SEARCH [OUT] button.
The display will indicate “MARK OUT,” and this location will be specified as the auto punch-out point.

Note: It is not possible to perform auto punch-in/out if the auto punch-out point is earlier than the auto punch-in point.

Note: When the MD4S is turned off, the auto punch-in/out points you set will be lost.

Tip: Auto punch-in/out points can be adjusted in steps of a single frame (11.6 ms). (See “Adjusting the location of a marker or auto punch-in/out point” on page 63 for more information.)

■ Setting the pre-roll/post-roll times

“Pre-roll time” is the length of playback that will occur immediately before the punch-in point. “Post-roll time” is the length of playback that will occur immediately after the punch-out point. On the MD4S, the pre-roll and post-roll times are each set to 5 seconds, but you can modify this if desired. The location at which the pre-roll starts is called the “pre-roll point,” and the location at which the post-roll ends is called the “post-roll point.”

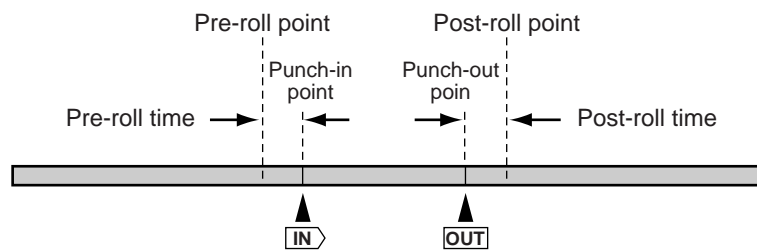

1. Press the UTILITY button.
2. Rotate the DATA dial until the display indicates "PrePostRoll," and press the ENTER button.
3. With the display showing "Pre Xsec" (X will be a number of 0–9), rotate the DATA dial to set a pre-roll length of 0–9 seconds.
4. After you have made the pre-roll setting, press the ENTER button.
5. Rotate the DATA dial until the display indicates "Post Xsec" (X will be a number of 0–9), and rotate the DATA dial to set a post-roll length of 0–9 seconds.
6. After you have made the post-roll setting, press the ENTER button.
7. Press the UTILITY button once again to return to normal operation.

Note: Pre-roll/post-roll time settings are remembered even if the MD4S is turned off.

■ Single-take auto punch-in/out

There are two types of auto punch-in/out: "single-take" in which auto punch-in/out is performed only once, and "mult-take" in which punch-in/out can be performed two or more times, after which you can select the best take. Here we will explain the procedure for single-take auto punch-in/out.

1. Connect the audio source to the MD4S, and press the REC SELECT button (or the BUS button + REC SELECT button) to select the track that you wish to record.
2. Set the auto punch-in/out points.
See "*Specify the auto punch-in/out points*" on page 55 for more information.
3. Press the AUTO PUNCH I/O button.
The display will indicate "SINGLE TAKE."
4. Press the ENTER button.
The AUTO PUNCH SINGLE indicator in the display will light, indicating that single-take auto punch-in/out has been selected.
The display will also indicate "A.Punch Rehe," and the MD4S will be in auto punch-in/out rehearsal-pause mode.

Rehearsing the auto punch-in/out (single-take)

5. Press the PLAY button, and begin rehearsing the auto punch-in/out.
When you press the PLAY button, the MD4S will automatically locate to the pre-roll point, and will start playback. When the auto punch-in point is reached, the IN indicator in the display will disappear, and the monitor signal will switch from the track playback to the recording source. When the auto punch-out point is reached the OUT indicator in the display will go dark, and the monitor signal will revert to the track playback. (In rehearsal mode, recording will not actually take place during this time.) After the auto-punch out point is passed and the post-roll is reached, the MD4S will automatically locate to the pre-roll point, and again enter auto punch-in/out rehearsal-pause mode.

Tip: When the display shows “A.Punch Rehe,” you can begin rehearsing the auto punch-in/out simply by pressing the PLAY button. (It is not necessary to press the REHE button.)

Tip: If you press the REPEAT button while rehearsing auto punch-in/out, the auto punch-in/out rehearsal will repeat automatically.

Actually performing the auto punch-in/out (single-take)

6. When stopped or paused, press the REC button.
The REC indicator will blink, the display will indicate “A.Pnch,” and the MD4S will be in auto punch-in/out record-pause mode.
7. Press the PLAY button to begin the actual auto punch-in/out.
When you press the PLAY button, the MD4S will automatically locate to the pre-roll point, and begin playback. When you reach the auto punch-in point, the IN indicator of the display will go dark, and the track selected by the REC SELECT buttons will begin recording (punch-in). When you reach the auto punch-out point, the OUT indicator of the display will go dark, recording will end, and playback will resume (punch-out). When the post-roll point is reached, auto punch-in/out will automatically be defeated, and the MD4S will locate to the pre-roll point and automatically enter playback-pause mode.
8. Press the PLAY button to hear the recorded result.

Note: In the case of single-take auto punch-in/out, auto punch-in/out will automatically be canceled when you perform the actual punch-in/out. If you wish to perform auto punch-in/out once again, you must repeat the procedure from step 1.

Tip: If an optional FC5 foot switch is connected to the PUNCH I/O jack, you can use the foot switch to perform steps 4 and 6.

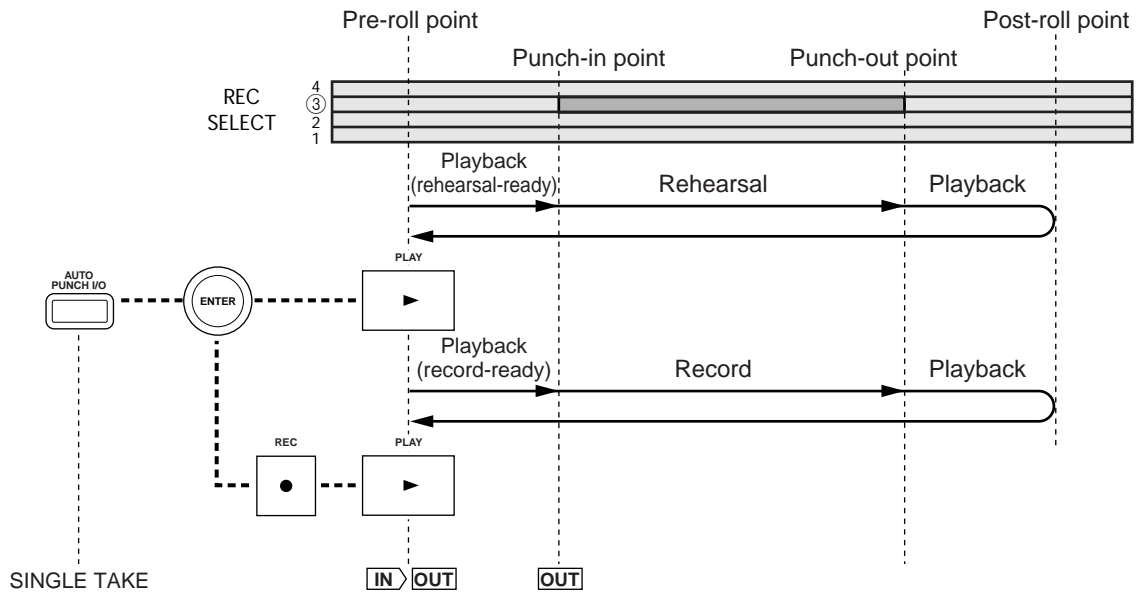

■ Multi-take auto punch-in/out

Multi-take auto punch-in/out allows you to perform auto punch-in/out recording two or more times, then to audition all takes (including the original) and select the best take. Multi-take auto punch-in/out allows you to record up to 99 takes, as long as blank area remains.

1. Connect an audio source to the MD4S, and press a REC SELECT button (or the BUS button + REC SELECT button) to select the track that you wish to record.
2. Set the auto punch-in/out points.
See “Specify the auto punch-in/out points” on page 55 for more information.
3. Press the AUTO PUNCH I/O button.
The display will indicate “SINGLE TAKE.”
4. Rotate the DATA dial to make the display read “MULTI TAKE.”
5. Press the ENTER button.
The display will indicate “TAKE 1 Load” for a short time. Then the AUTO PUNCH MULTI indicator will light, indicating that multi-take auto punch-in/out has been selected. The display will indicate “TAKE 1 Rehe,” and the MD4S will be in auto punch-in/out rehearsal-pause mode.

Rehearsing the auto punch-in/out (multi-take)

6. Press the PLAY button to begin rehearsing the auto punch-in/out.
In the same way as in single-take auto punch-in/out, the monitor signal of the track selected for recording will switch from the track playback to the recording source between the auto punch-in/out points. Recording will not actually occur.

Tip: While rehearsing the auto punch-in/out, you can press the REPEAT button to automatically repeat the rehearsal.

Actually performing the auto punch-in/out (multi-take)

7. From a stopped or paused condition, press the REC button.
The REC indicator will blink, and the display will indicate "TAKE 1." Auto punch-in/out will be in record-pause mode, ready to record the first take (take 1).
8. Press the PLAY button to begin the actual auto punch-in/out.
When you reach the post-roll point, the MD4S will automatically stop, and the display will indicate "NEXT TAKE."

Recording the next take

9. With "NEXT TAKE" shown in the display, press the ENTER button.
The display will briefly indicate "TAKE 2 Load." Then the display will change to "TAKE 2," and the MD4S will be in record-pause mode for take 2 of the auto punch-in/out.

Note: Takes 2 and following will always begin with the actual auto punch-in/out. If you wish to rehearse, you must press the REHE button.

10. Press the PLAY button to begin auto punch-in/out.
When you reach the post-roll point, the MD4S will automatically stop, and the display will indicate "NEXT TAKE." If you wish to record another take, press the ENTER button to enter record-pause mode for the next take. If you wish to listen to the takes that you have recorded, advance to the following procedure with "NEXT TAKE" still displayed.

Auditioning each take

11. When you have finished recording auto punch-in/out takes and the display indicates "NEXT TAKE," rotate the DATA dial to make the display read "MONI TAKE."
12. Press the ENTER button.
The display will indicate "TAKE X:MONI" (X will be the take number).
13. Rotate the DATA dial to select the take that you wish to hear, and press the ENTER button to playback the selected take.
When you reach the post-roll point (or press the STOP button), the MD4S will stop, and you will again be able to select a take.
If you press the EXIT button when the display reads "TAKE X:MONI," you will return to the "NEXT TAKE" display.

Tip: To audition the original, rotate the DATA dial to make the display read "ORIGIN:MONI."

Selecting the best take

14. When the display reads "TAKE X:MONI," rotate the DATA dial to select the best take.
The "TAKE X" display will blink.
15. Rotate the CURSOR shuttle toward the right to make the "MONI" display blink.

16. Rotate the CURSOR shuttle toward the right to make the display read "TAKE X:FIX."
17. Press the ENTER button.
The display will ask "FIX TAKE X?" If at this time you press the EXIT button, you will again return to the step of selecting a take.
18. Press the ENTER button once again to finalize the take.
When you finalize the take, the display will indicate "TAKE X FIX" for a short time. Then you will exit auto punch-in/out and return to normal operation.

Quick search functions

This section explains the variety of Locate functions that are provided by the MD4S. Methods of adjusting the auto punch-in/out points and ways to set Markers will also be explained here.

Searching for songs

If the disc contains two or more songs, you can use the SONG SEARCH [◀◀]/[▶▶] buttons to locate songs. The SONG SEARCH [◀◀] button locates the previous song, and the SONG SEARCH [▶▶] button locates the next song. The MD4S will pause at the beginning of the selected song.

If you press the SONG SEARCH [◀◀] button while stopped during a song, the MD4S will locate to the beginning of the song and then pause. If you press the SONG SEARCH [◀◀] button while a song is playing, the MD4S will locate to the beginning of the song and then immediately begin playback.

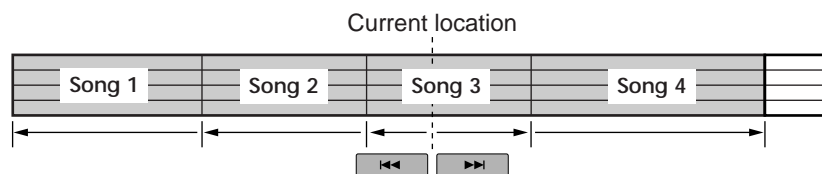

Note: If you press the SONG SEARCH [▶▶] button when the last song is selected, the MD4S will search for a blank area. (See page 12 for more information.)

Note: The SONG SEARCH buttons cannot be used during recording.

Locating to a specified time

By using the DATA dial and CURSOR shuttle to input a minute/second/frame location, you can locate to a desired location of the disc. If a tempo map (page 111) has been programmed, you can input and locate to a measure/beat/clock location.

1. Press the STOP or PAUSE button to stop or playback-pause the MD4S. It is not possible to locate to a specified time during playback or recording.
2. Press the DISPLAY button to switch the time counter mode. If you wish to locate to a point within the current song, select ELAPSE TIME (or REMAIN TIME). If you wish to locate to a point within the entire disc, select TOTAL TIME. If a tempo map has been programmed for the current song, you can switch the time counter to the measure/beat/clock display.
3. Use the CURSOR shuttle and the DATA dial to specify the desired locate position. By moving the CURSOR shuttle to various angles left or right you can play forward or backward at a variety of speeds, which provides a convenient way to reach the approximate location you desire. As you rotate the DATA dial to left or right, you will move backward or forward in steps of one frame for each click of the dial, allowing you to specify the desired location more precisely.

- When you have specified the desired location, press the ENTER button. The MD4S will locate to the specified location, and will enter playback-pause mode. If you press the PLAY button instead of the ENTER button, playback will begin from the specified location.

Locating to the Last Record In/Out Point

When you record or rehearse, the starting location and ending location will automatically be remembered as the “last record in point” and the “last record out point.” When these points have been set, the IN/OUT indicators in the display will light.

If the last record in/out points have been set, you can use the LAST REC SEARCH [IN] button to locate to the “last record in point,” or the LAST REC SEARCH [OUT] button to locate to the “last record out point.” The MD4S will then enter playback-pause mode. When you locate to the last record in or out point, the respective IN/OUT indicator will begin blinking. The LAST REC SEARCH [IN] button provides a convenient way to check the result of the last recording.

The last record in/out points are also used as the auto punch-in/out points and to specify the range of various editing functions. These points can be adjusted in steps of a single frame (11.6 ms). (For details refer to page 63.)

Note: The last record in/out points will be lost when the MD4S is turned off.

Searching for Markers

The MD4S lets you place up to ten markers in each song. You can use the MARK SEARCH [◀][▶] button to locate immediately to markers that you inserted. Markers are especially convenient when you need to repeatedly jump to specific points in a song. The location of a marker you insert can be adjusted later in steps of a single frame.

Inserting a marker in a song

- At the location where you wish to insert a marker, press the MARK button. Markers can be inserted when the MD4S is playing back, recording, paused, or stopped. When you press the MARK button, the display will indicate “MARK X” (X will be the marker number that was inserted) for a brief time, indicating that a marker has been inserted at that location. Markers are numbered sequentially, starting from the beginning of the song. If a new marker is inserted between two existing markers, the marker numbers will be exchanged.

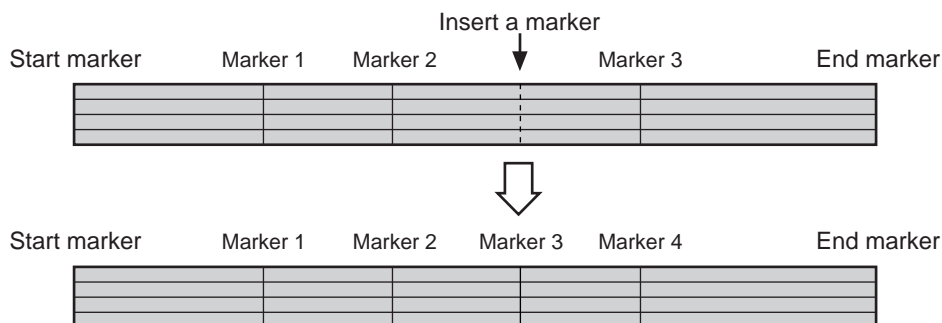

- Press the TOC WRITE button to update the TOC.

Note: If you turn off the power of the MD4S without updating the TOC, the marker settings will be lost.

Locating to a marker

- Use the MARK SEARCH [◀]/[▶] buttons to locate to a marker you inserted. The MARK SEARCH [◀] button will locate to a marker earlier than the current location, and the MARK SEARCH [▶] button will locate to a marker after the current location. The MD4S will then enter playback-pause mode. If no marker has been inserted, the MARK SEARCH [◀] button will locate to the start marker (the beginning of the song), and the MARK SEARCH [▶] button will locate to the end marker (the end of the song).

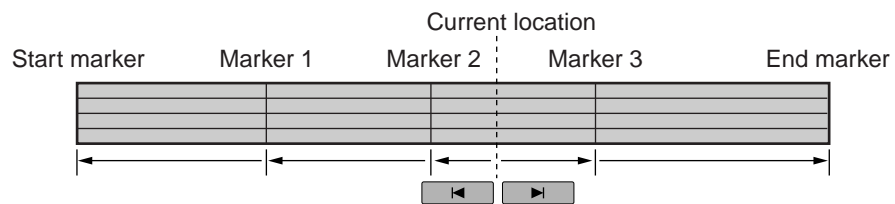

Tip: The marker indicator in the display shows the marker that corresponds to the current location. When an indicator for a marker you inserted is blinking, the current location is between that marker and the next marker.

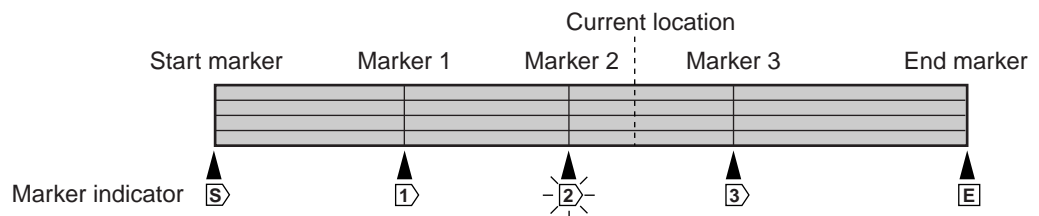

Adjusting the location of a marker or auto punch-in/out point

Here's how you can make fine adjustments in steps of a single frame to the location of a marker or an auto punch-in/out point. This procedure can be performed when the MD4S is stopped or when it is in playback-pause mode.

- Press a MARK SEARCH button or a LAST REC SEARCH button to locate to the marker or auto punch-in/out point whose location you wish to adjust.
- Press the ADJUST button.

If you pressed a MARK SEARCH button in step 1, the display will indicate "MARK X:ADJUST" (X will be the number of the marker that you selected), and "MARK X" will be blinking. If you pressed a LAST REC SEARCH button, the display will indicate "IN:ADJUST" (auto punch-in point) or "OUT:ADJUST" (auto punch-out point). At this time you can rotate the DATA dial to select another marker or auto punch-in/out point.



3. Press the ENTER button.

The display will indicate “AdjstLoad...” for a short time. Then the display will change to “ADJST 0 ” and the track will play back for approximately 1.5 seconds before and after the point you selected in step 1. At this time, there will be a volume difference between the first 1.5 seconds and the last 1.5 seconds, so that you can hear exactly where the marker occurs.

4. Press the PLAY button, and while listening to playback 1.5 seconds before and after the marker, rotate the DATA dial to adjust the location of the marker in single-frame units (11.6 ms).

When you rotate the DATA dial to move the marker backward or forward, the display will indicate “ADJST XXX ” (XXX is the number of frames that the marker was moved.)

5. As necessary, rotate the CURSOR shuttle to invert the high/low volume change.

By rotating the CURSOR shuttle to left or right you can invert the high/low volume change that occurs between the first 1.5 seconds and the last 1.5 seconds. If the display indicates , the first 1.5 seconds will be played at a lower volume. If the display indicates , the last 1.5 seconds will be played at a lower volume.

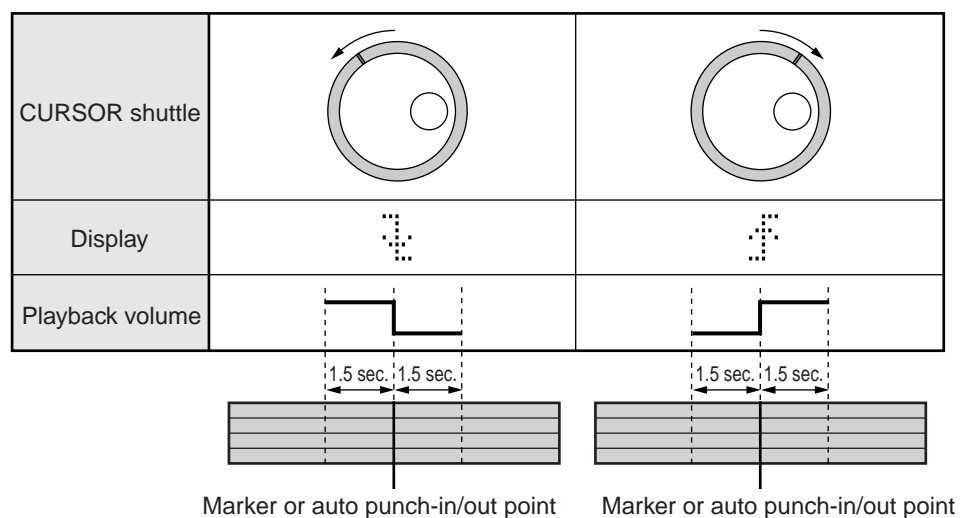

Tip: 1.5 seconds before and after the marker will also playback immediately after you rotate the CURSOR shuttle. If you keep inverting the volume difference while you listen, it will be easier to make accurate adjustments to the position.

6. When you have finished making adjustments, press the ENTER button.
The new location will be finalized, and the MD4S will locate to that spot. The display will return to the state in which it was before you press the ADJUST button in step 2.
7. Press the ADJUST button once again to return to normal operation.
8. Press the TOC WRITE button to update the TOC.

Note: The frames with which we are dealing here are 11.6 ms units. Do not confuse them with MTC frames. If MTC frames are displayed in the time display, the adjusted location may not be reflected by the time counter.

Note: This method can be used to make fine adjustments in a range of approximately 10 seconds forward or backward from the selected marker (or auto punch-in/out point). If you wish to make adjustments that would be further than this range, you will need to either repeat steps 2–6, or re-set the point that you wish to adjust. If another marker has already been inserted before or after the marker (or auto punch-in/out point) that you are moving, it is not possible to move these markers past each other.

Erasing a marker or auto punch-in/out point

Here's how to erase a marker location or auto punch-in/out point that you have set. This procedure can be performed when the MD4S is either stopped or in playback-pause mode.

1. Press a MARK SEARCH or LAST REC SEARCH button to locate to the marker or the auto punch-in/out point that you wish to erase.
2. Press the ADJUST button.
The display will indicate "MARK X:ADJUST" or "IN:ADJUST" or "OUT:ADJUST," and the word on the left (MARK X/IN/OUT) will blink. At this time, you may rotate the DATA dial to select a different marker or auto punch-in/out point.
3. Rotate the CURSOR shuttle toward the right.
The word "ADJUST" in the display will blink.
4. Rotate the DATA dial toward the right.
The word "ADJUST" in the display will change to "CLEAR."
5. Press the ENTER button.
If you are erasing a marker, the display will indicate "CLR MARKX?" (X will be the marker number). By pressing the EXIT button at this point you can cancel the Erase operation.
6. Press the ENTER button once again to erase the marker, or press the EXIT button to cancel the Erase operation.
The marker indicator (or IN/OUT indicator) that corresponds to the erased marker (or auto punch-in/out point) will go dark. Depending on the marker that was erased, the marker numbers will change.

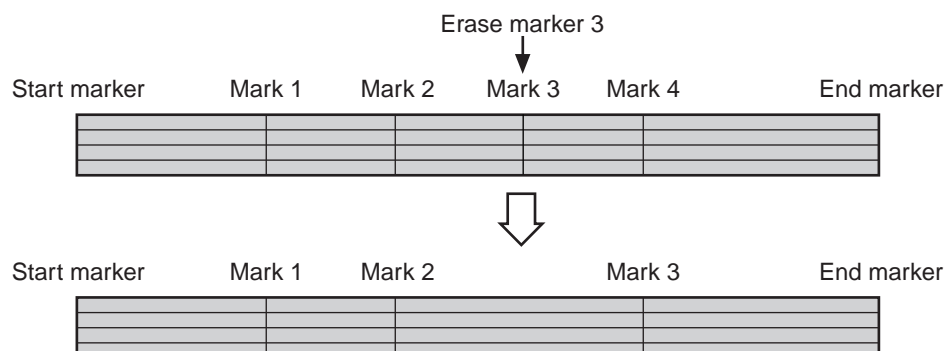

7. Press the ADJUST button or the EXIT button to return to normal operation, and press the TOC WRITE button to update the TOC.

Various playback functions

This section explains the various playback functions offered by the MD4S.

Play forward/backward at various speeds (Cue/Review)

During playback, you can operate the CURSOR shuttle to play forward (cue) or backward (review) at various speeds. This is a convenient way to find the desired location within a song.

1. Press the PLAY button to begin playback.
2. Move the CURSOR shuttle to right or left to Cue or Review.
The cue/review speed will depend on the angle to which you move the CURSOR shuttle.

Cue (play forward)

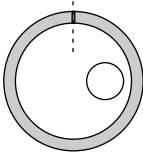
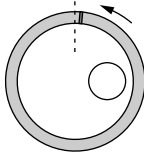
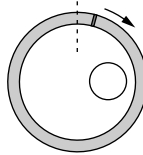
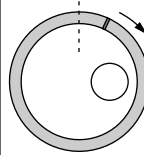
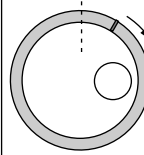
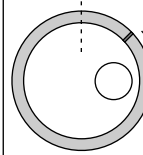
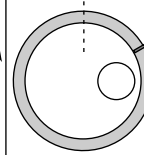
Speed	Normal playback	1/2X speed	2X speed	4X speed	8X speed	16X speed	32X speed
Display		CueHALF	Cue x2	Cue x4	Cue x8	Cue x16	Cue x32
CURSOR shuttle							

Review (play backward)

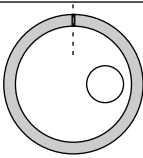
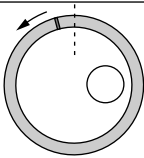
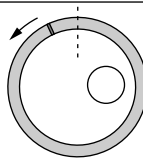
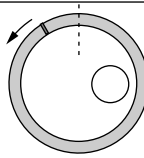
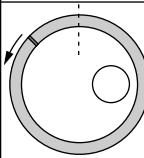
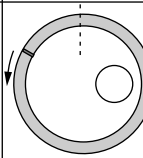
Speed	Normal playback	1/2X speed	4X speed	8X speed	16X speed	32X speed
Display		Rev x2	Rev x4	Rev x8	Rev x16	Rev x32
CURSOR shuttle						

Note: It is not possible to move directly from normal playback to 1/2X speed cue. You must move the CURSOR shuttle toward the right to select 2X cue or faster, and then return the CURSOR shuttle to the 1/2X speed cue position.

3. If you press the ENTER button while using cue/review, the cue/review will be locked (fixed).

Cue/review will continue even if you release the CURSOR shuttle. When you press the PLAY button, cue/review will be canceled, and normal playback will resume from that location. If cue/review reaches the beginning or end of the song, it will stop.

Note: When 1/2X speed cue is used, the playback pitch will be one octave lower than normal. (This is the same effect as the 1/2X speed playback explained below.) However, the pitch will not change for cue/review at other speeds.

Playback at half speed (x1/2 Play)

x1/2 Play is a function that drops the pitch of the disc to half the normal pitch during playback. When x1/2 Play is used, the pitch will be one octave lower than normal. (This is the same effect as Cue-Half.) This provides a convenient way to practice rapidly-played phrases that you have recorded from a CD etc.

Note: Recording or rehearsal cannot be performed at X1/2 Play. Nor will it be possible to synchronize with a MIDI sequencer using MTC or MIDI Clock while using x1/2 Play.

1. Press the UTILITY button.
2. Rotate the DATA dial until the display indicates "X1/2 Play," and press the ENTER button.
The display will indicate "X1/2 OFF." The HALF indicator will light.
3. Rotate the DATA dial to make the display indicate "X1/2 ON," and press the ENTER button.
X1/2 Play will be active.
4. To turn off the X1/2 Play function, rotate the DATA dial to make the display read "x1/2 OFF" and press the ENTER button.

Playing a song repeatedly (One Song Repeat/All Song Repeat)

The One Song Repeat function causes a single song to playback repeatedly. The All Songs Repeat function causes all songs on the disc to playback repeatedly. These functions can be selected when the MD4S is playing, stopped, or paused.

1. Press the REPEAT button to select the desired Repeat function.
Each time you press the button, the selection will cycle between One Song Repeat, All Song Repeat, and Repeat function off. The display will indicate the selected Repeat function.

REPEAT 1One Song Repeat is selected. The currently selected song will continue playing.

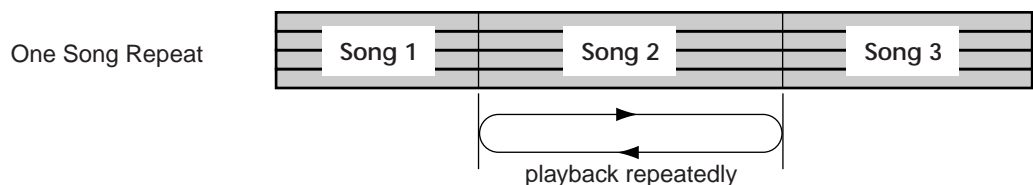

REPEAT ALLAll Song Repeat is selected. All songs on disc will continue playing repeatedly.

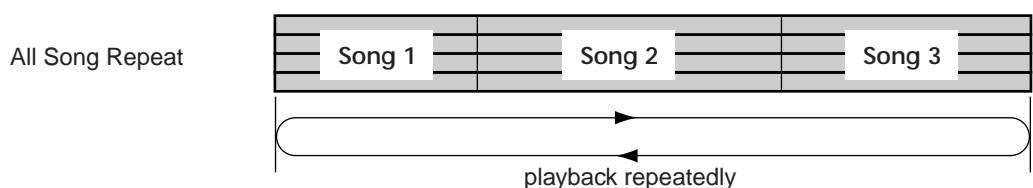

2. To turn off the Repeat function, press the REPEAT button until the Repeat indicator goes dark.

Repeating a specific portion of a song (A-B Repeat)

A-B Repeat is a function that causes the portion of a song between a specified point A and point B to playback repeatedly. The A and B points can be in different songs if desired. The A and B points can be set while the MD4S is playing, stopped, or in playback-pause mode.

1. At the beginning of the desired repeat, press the A \curvearrowright B button.
The Repeat indicator in the display will indicate "REPEAT A," indicating that the beginning of the repeat (point A) has been specified.
2. At the end of the desired repeat, press the A \curvearrowright B button once again.
The Repeat indicator in the display will indicate "REPEAT A B," indicating that the end of the repeat (point B) has been specified. When you specify point B, the MD4S will automatically locate to point A, and will begin playing repeatedly between points A and B.
3. During A-B Repeat, press the REPEAT button to turn off the A-B Repeat function.
A-B Repeat will also be canceled if you press the STOP button.

Note: When A-B Repeat is turned off, points A and B will be reset. If you wish to temporarily stop A-B Repeat playback, use the PAUSE button.

Cue List playback

Cue List is a function that lets you playback sections between markers in an order that you specify. You can set up to 26 steps (A-Z), each specifying the marker at which playback will begin and end, and the number of times that each step will repeat.

Programming a Cue List

1. Press the UTILITY button.
2. Rotate the DATA dial to make the display indicate "Cue List," and press the ENTER button.
The display will indicate "EDIT List."
3. Rotate the DATA dial to select either "EDIT List" or "NEW List."
If you wish to create a new cue list, select "NEW List." If you wish to recall an existing cue list, select "EDIT List."
4. Press the ENTER button to begin programming the cue list.
The display will show the first step (A). The blinking letter is the currently selected parameter.

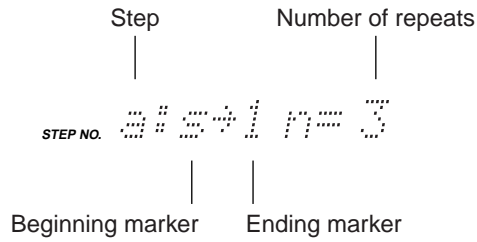

- Use the CURSOR shuttle to select a parameter, and rotate the DATA dial to modify the setting.

The range of each parameter is as follows.

Step A-Z (while programming, this is shown as lowercase letters a-z)

Beginning/ending markers s, 1-10, e (numerals are marker numbers, 's' and 'e' are the start marker and end marker respectively)

Number of repeats 0-99

Tip: If you rotate the CURSOR shuttle to the right when the Number of Repeats parameter is selected, you will advance to the next step. If you rotate the CURSOR shuttle toward the left when the Step parameter is selected, you will return to the previous step.

If a cue list has been programmed as shown below, the portion between the start marker and marker 1 will be repeated twice, between marker 2 and marker 3 repeated twice, and between marker 3 and marker 4 repeated four times.

Cue List

```
a:s->1 n= 2
b:2->3 n= 2
c:3->4 n= 4
d:2->3 n= 1
e:3->4 n= 4
f:5->7 n= 2
g:s->1 n= 0
h:s->1 n= 0
i:s->1 n= 0
"      "
"      "
"      "
```

Playing a Cue List

- After you have finished programming the desired steps, press the ENTER button. The display will ask "List PLAY?"
- Press the ENTER button once again. The display will indicate the first step (A), and the MD4S will be in Cue List playback-pause mode. (During cue list playback, the steps will be shown as uppercase letters A-Z.) At this time you can rotate the DATA dial to change the step at which cue list playback will begin.
- Press the PLAY button to begin Cue List playback. When all steps have finished playing back, cue list playback will be canceled, and the MD4S will stop. If you wish to stop cue list playback while it is in progress, press the STOP button. If you press the PAUSE button to temporarily halt cue list playback, you can rotate the DATA dial to select a different step, and then resume cue list playback.

Note: In rare circumstances, playback may skip between steps of Cue List playback.

Note: Cue List program contents are remembered even when the MD4S is turned off.

■ Creating a new song from a Cue List (Cue List Copy)

The playback order that you have programmed in a cue list can be rewritten into a new song. As shown in the following diagram, this can be used to remake a song into a new version whose length and arrangement differ from the original song.

Original song

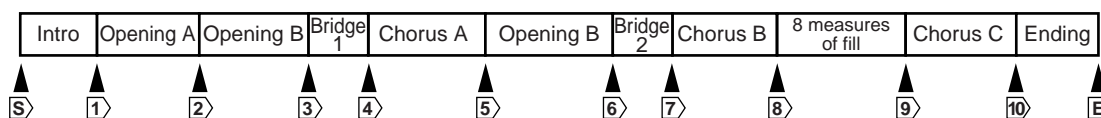

Cue List

a: s→1 n=2 (start the song by repeating the intro twice)
 b: 1→2 n=2 (Opening A played twice)
 c: 2→3 n=1 (Opening B)
 d: 6→7 n=1 (Bridge 2)
 e: 4→5 n=1 (Chorus A)
 f: 8→9 n=1 (the eight measures of fill are moved forward)
 g: 3→4 n=1 (Bridge 1)
 h: 7→8 n=2 (repeat Chorus B twice, and move it back)
 i: 10→e n=2 (repeat the Ending twice and fade out)

New song after Cue List Copy

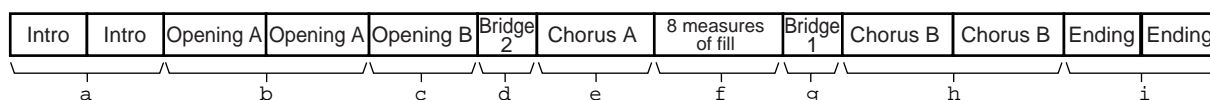

1. As described in steps 1–5 of “Programming a Cue List” on page 68, program the desired cue list.
2. Press the ENTER button.
The display will ask “List PLAY?”
3. Rotate the DATA dial to make the display read “List COPY?”
4. Press the ENTER button to execute the Cue List Copy operation.
The display will briefly indicate “CopyTo X” (X is the copy destination song number), and then a new song will be created. By pressing the STOP button while “CopyTo X” is displayed, you can cancel the Cue List Copy operation.
When the cue list copy has been completed, the TOC will be updated automatically and the MD4S will stop at the beginning of the new song.

Programming the song playback order (Program Play)

Program Play is a function that lets you program the playback order of the songs on disc. You can specify up to 36 steps of song numbers for playback.

1. Press the UTILITY button.
2. Rotate the DATA dial to make the display read "Prog Play," and press the ENTER button.
The display will indicate "EDIT Prog."
3. Rotate the DATA dial to select either "EDIT Prog" or "NEW Prog."
If you wish to create a new program, select "NEW Prog." If you wish to recall an existing program, select "EDIT Prog."
4. Press the ENTER button to begin programming.
The display will indicate the parameters of each step. The blinking character is the currently selected parameter.

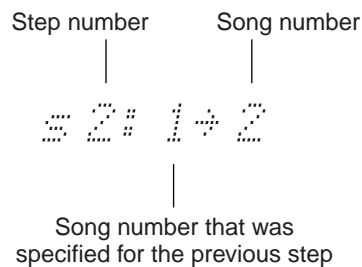

5. Rotate the CURSOR shuttle to select parameters, and rotate the DATA dial to modify the value.
The range of each parameter is as follows.
Step numberS1–S36 (S will be displayed as a lowercase letter during programming)
Song number*, song number (* indicates that no song number has been specified for this step)

Note: For steps 2 and following, the song number specified for the previous step will also be displayed. However this is only for your information, and cannot be modified.

Tip: If you rotate the CURSOR shuttle to the right when the Song Number parameter is selected, you will advance to the next step. If you rotate the CURSOR shuttle toward the left when the Step parameter is selected, you will return to the previous step.

With the program shown in the following diagram, playback will occur in the order of Song 1 → Song 3 → Song 2 → Song 2.

Program Play

S 1:	1
S 2:	1→ 3
S 3:	3→ 2
S 4:	2→ 2
S 5:	2→ 9
S 6:	9→ 5
S 7:	5→ 1
S 8:	1→ *
S 9:	*→ *
S10:	*→ *
S11:	*→ *
.	.
.	.
.	.
.	.

6. After you have entered all of the desired steps, press the ENTER button. The display will show the first step (S1), and the MD4S will be in Program Play playback-pause mode. (In Program Play, the S for “Step” will be show as an uppercase character.) At this time, you can use the SONG SEARCH buttons to change the step at which Program Play will begin.
7. Press the PLAY button to begin Program Play. When all steps have finished playing back, the MD4S will stop. By pressing the STOP button during Program Play, you can also cancel Program Play and stop.

Tip: If you press the PAUSE button during Program Play, the playback will pause temporarily, and you can use the PLAY button to resume Program Play. While paused, you can also use the SONG SEARCH buttons to change the step from which Program Play will resume.

Note: Program Play settings are remembered even when the MD4S is turned off.

Editing functions

This sections explains the track and song editing functions that are provided on the MD4S.

Copying a portion of a track (Part Copy)

Part Copy is a function that copies a portion of a track to a different location within the same track or to the desired location in another track. You can also copy between songs. This function is useful when you wish to re-use a specific phrase in a different place.

1. Specify the Last Record In/Out points to set the Copy Source area.
Locate to the beginning of the copy source area. Hold down the SET button and press the LAST REC SEARCH IN button to set the Last Record In point. Then locate to the end of the copy source area. Hold down the SET button and press the LAST REC SEARCH OUT button to set the Last Record Out point. When you set each point, the IN/OUT indicators in the display will light.

Tip: Last Record In/Out points (auto punch-in/out points) can be adjusted in single-frame units (1/86 second). See “Adjusting the location of a marker or auto punch-in/out point” on page 63 for more information.

2. Locate to the copy destination, and stop or pause playback.
The location at which you stop or pause will be the beginning of the copy destination.

Tip: If you use the SONG SEARCH buttons to select a different song, the track in the selected song will be copy destination track.

Note: The copy destination area must not extend beyond the end of the song. Also, when copying within the same track, the copy destination area must not overlap the copy source area.

3. Press the EDIT button.
4. Rotate the DATA dial to make the display read “Part Copy,” and press the ENTER button.
The display will show the copy source track and the copy destination track.
The currently selected parameter will blink.

Copy source track number Copy destination track number

COPY T1+T2

5. Use the CURSOR shuttle and the DATA dial to specify the copy source track number and the copy destination track number.
If “*” is shown for a track number parameter, the Part Copy operation cannot be executed.
6. After you have set the copy source and copy destination tracks, press the ENTER button.
The display will ask “COPY EXE?” If you press the EXIT button at this point, the Part Copy operation will be canceled.

- Press the ENTER button once again to execute the Part Copy operation. While the Part Copy is being executed, the display will indicate "COPY EXE.." and the track record indicator (DIR) for the copy destination track will light. If you press the STOP button at this time, the copy can be interrupted. When the copy is completed, the MD4S will stop.

Note: When you execute the copy operation, the content that had been recorded on the copy destination track will be erased.

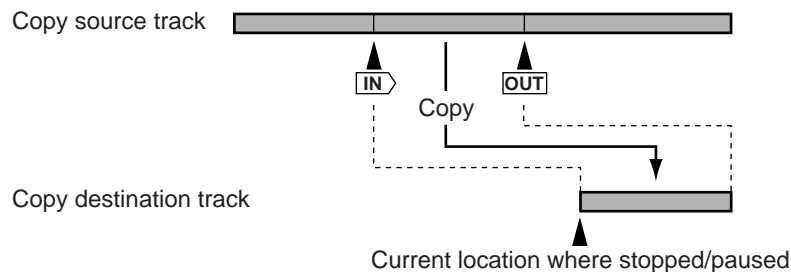

Erasing a section of a track (Part Erase)

The Part Erase function erases a section portion of a track. You can select two or more tracks for erasure. The section that was erased will be silent.

- At the beginning of the section you wish to erase, press the SET button + LAST REC SEARCH [IN] button. At the end of the section, press the SET button + LAST REC SEARCH [OUT] button.

The last record in/out points will be set, and the area between them will be selected for erasure. When you set each point, the IN/OUT indicator in the display will light.

- Press the EDIT button.
- Rotate the DATA dial to make the display read "Part Erase," and press the ENTER button.

The display will show the track from which data will be erased.

The currently selected parameter will blink.



- Rotate the CURSOR shuttle to select tracks, and rotate the DATA dial to specify whether or not data will be erased from each track.

Data will be erased from the track numbers shown. (The tracks shown as "*" will not be erased.) For example if the display indicates "1**4T," the specified area of tracks 1 and 4 will be erased. If all tracks show "*", the Part Erase operation will not be executed.

- Press the ENTER button.

The display will ask "Erase EXE?" If you wish to cancel the operation at this point, press the EXIT button.

Erasing an entire track (Track Erase)

Track Erase is a function that erases an entire track. You can select one or more tracks to erase. The erased track(s) will contain only silence.

1. Press the EDIT button, and rotate the DATA dial to make the display read "Track Erase." Then press the ENTER button.

The display will show the parameter that specifies the track(s) to be erased.

The currently selected parameter will blink.

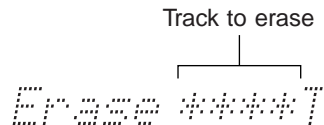
Track to erase

2. Use the CURSOR shuttle and the DATA dial to select the track(s) that will be erased.

Tracks whose numbers are shown will be displayed. (Tracks for which "*" is displayed will not be erased.) For example with settings of "12**T," tracks 1 and 2 will be erased. If all tracks are "*" the Track Erase operation cannot be executed.

3. Press the ENTER button.

The display will ask "Erase EXE?" If you wish to cancel the Track Erase operation, you can press the EXIT button at this time.

4. Press the ENTER button once again to execute the Track Erase operation.

While Track Erase is being executed, the display will indicate "Erase EXE.." and the track record indicator (DIR) for the track(s) being erased will light. The Track Erase operation takes four minutes for a four-minute song. While the operation is in progress, tracks not being erased will play back.

Note: By pressing the STOP button, you can stop the Track Erase operation mid-way through its progress. However, in this case, the data between the point at which Track Erase was executed until the STOP button was pressed will already have been erased.

Copying/convertng a song (Song Copy)

Song Copy is a function that duplicates an entire song, including the title, markers, and tempo map data. It is convenient to use this function to create a backup of the original song before performing ping-pong recording or punch-in/out recording. If desired, the recording mode (4TR/2TR/MONO mode) of the copy destination song can be converted, and you may change the order of the tracks. (For more on the recording modes, refer to page 11.)

1. Use the SONG SEARCH buttons to select the copy source song, and press the ENTER button.
2. Rotate the DATA dial to make the display read "Song Copy," and press the ENTER button.

The display will ask "Copy X?" (X is the copy source song number). At this time you can rotate the DATA dial to select a different song number.

- Press the ENTER button once again.
The display will indicate the recording mode and track order of the copy source song.

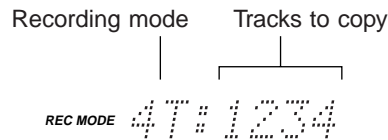

If you wish to create a complete duplicate of the song without changing the recording mode or track order, proceed to step 7.

Changing the record mode

- Rotate the DATA dial to select the recording mode of the copy destination song.

The following recording modes are available for conversion.

- 4T (4TR mode)
- 2T (2TR mode)
- MO (MONO mode)

For example if you specify "2T:12" the copy destination song will be as follows.

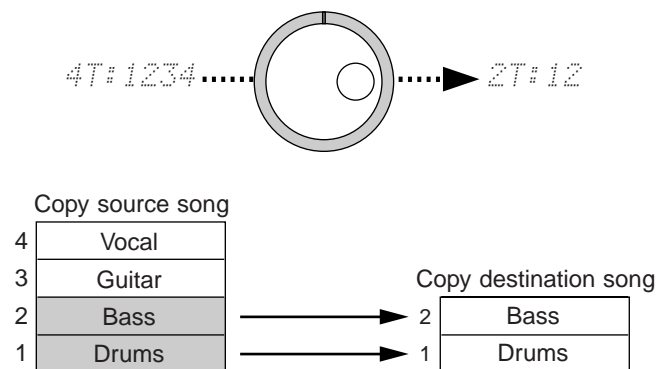

Changing the order of the tracks

- Rotate the CURSOR shuttle to the right.
The numerals indicating the track order will blink.
- Use the CURSOR shuttle to select the track whose order you wish to change, and rotate the DATA dial to specify the copy source track number.
The currently selected track will blink. Rotate the DATA dial to select the copy source track number (1–4) or "-". If you select "-", the corresponding track of the copy destination will be blank (silent).

For example if you specified “4T:3421,” the order of copy destination tracks would be as follows.

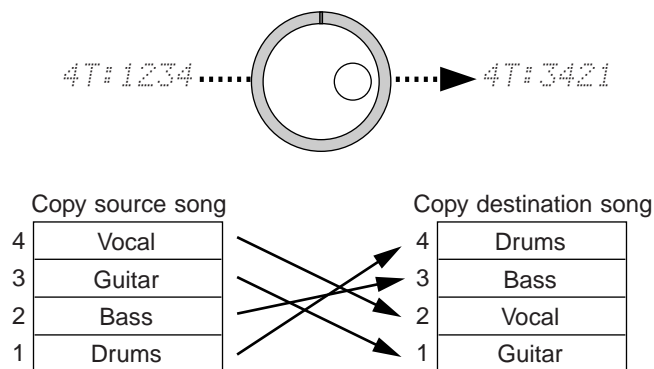

Tip: You can specify the same track number more than once. For example if you specify “4T:3422” the contents of copy source track 2 will be copied to tracks 3 and 4.

Executing the Song Copy

7. When you have finished making settings, press the ENTER button. The display will indicate “Copy to BX” (X is the number of a blank area).
8. Rotate the DATA dial to specify the copy destination blank area.
9. Press the ENTER button. The display will ask “Copy EXE?” If you decide to cancel the Song Copy, press the EXIT button.
10. Press the ENTER button to execute the Song Copy operation. The display will indicate “CopyTo X” (X is the song number of the copy destination) for a time, and when the copy is completed, the TOC will be updated automatically and the MD4S will select the copy destination song and then stop.

Erasing a song (Song Erase)

Song erase is a function that erases an entire song. The song that was erased will become a blank area. Use this function when you need to increase disc space in order to record a new song.

1. Press a SONG SEARCH button to select the song you wish to erase.
2. Press the EDIT button, and rotate the DATA dial to make the display read “Song Erase.” Then press the ENTER button. The display will indicate “Song No. X” (X is the number of the song to be erased). At this time you can rotate the DATA dial to select a different song.
3. Press the ENTER button. The display will ask “Erase EXE?” If you decide to cancel the Song Erase operation, you can press the EXIT button now.

- Press the ENTER button once again to execute the Song Erase operation. The display will indicate "Erase EXE.", and the TOC will be updated automatically when the song has been erased.

Tip: If there are three consecutive songs as shown in the following diagram, erasing the middle song will create a new blank area that is independent of the other blank area. Now you can either record a new song in the blank area, or extend the length of Song 1.

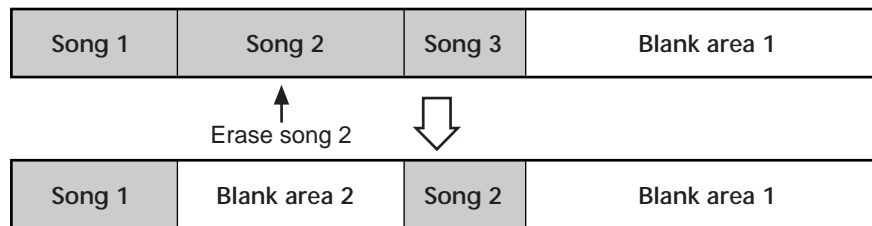

Note: When you erase a song, the numbers of all subsequent songs will be updated.

Splitting a song into two (Song Divide)

Song Divide is a function that splits a song into two parts. The Program Play function (page 71) can be used to rearrange the playback order of the newly-divided parts.

- Locate to the point at which you wish to divide the song, and stop or pause playback.
- Press the EDIT button. Then rotate the DATA dial to make the display read "Song Divide," and press the ENTER button.
The display will ask "Divide EXE?" If you decide to cancel the Song Divide operation, press the EXIT button now.
- Press the ENTER button once again to execute the Song Divide operation. When the song has been divided, the TOC will automatically be updated.
If markers had been placed in the original song, markers earlier than the Divide point will remain in the original song, and markers following the Divide point will be renumbered as markers of the new song.

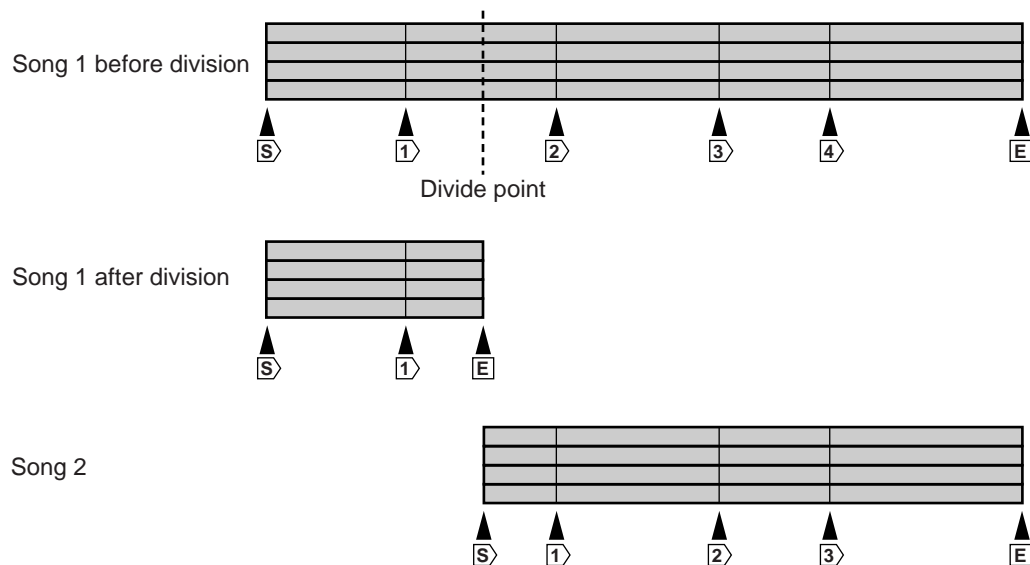

Note: When a song is divided, the song numbers of all subsequent songs will be updated. For example if you divide song 1, the first part of the divided song will be Song 1, the remainder will be Song 2, and the previous Song 2 will be renumbered as Song 3.

Joining divided songs together (Song Combine)

Song Combine is an operation that joins two previously-divided songs to create a single song.

Note: Separately-recorded songs cannot be joined.

1. Press the EDIT button, rotate the DATA dial to make the display read "Song Comb," and press the ENTER button.
The display will indicate the numbers of the two songs that are to be joined.

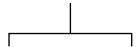
Song numbers to join

Cmbn 1+2

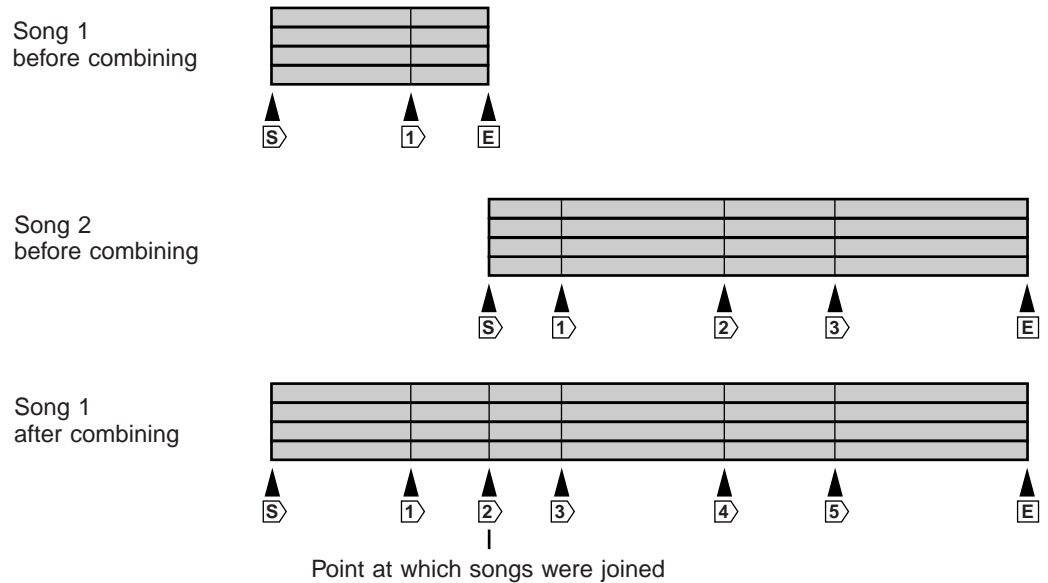
2. Rotate the DATA dial to select the songs that will be joined.
To join songs 3 and 4, select "Cmbn 3+4." If the display indicates "Cmbn *+*" the Song Combine operation cannot be executed.
3. Press the ENTER button.
The display will ask "Cmbn EXE?" If you decide to cancel the Song Combine operation at this point, press the EXIT button.
4. Press the ENTER button once again to execute the Song Combine operation.
After the songs have been combined, the TOC will automatically be updated.
If markers have been placed in the two songs being joined, the marker locations will remain in the newly-joined song. (Marker numbers will be updated automatically.) However since the point at which the songs were joined will be inserted as a new marker, the total number of markers in the song will be one more than the total number of markers in the two songs.



Note: If the total number of markers in the song (including the marker added at the point where the songs were joined) is eleven or more, it will not be possible to recall the eleventh or subsequent markers. However the locations of the eleventh and subsequent markers will still be remembered, and if one or more of the first ten markers is deleted, these later markers will once again become available. For the procedure of deleting a marker, refer to page 65.

Note: When you combine a song, the numbers of subsequent songs will be updated automatically. For example if you combine songs 1 and 2 into song 1, the following song number 3 will be renumbered as song number 2.

Moving a song (Song Move)

Song Move is a function that moves a song to a blank area. This is convenient when you wish to record additional material to extend a previously-recorded song, or to organize the blank area on a disc.

1. Use the SONG SEARCH buttons to select the song that you wish to move.
2. Press the EDIT button, rotate the DATA dial to make the display read "Song Move," and press the ENTER button.
The display will ask "Move X?" (X is the number of the song that will be moved). At this time you can rotate the DATA dial to select a different song.
3. Press the ENTER button.
The display will read "Move to BX" (X is the number of the blank area to which the song will be moved).
4. Rotate the DATA dial to select the blank area to which the song will be moved.

Note: It will not be possible to select a blank area that is shorter than the song being moved.

- Press the ENTER button.
The display will ask “Move EXE?” If you decide to cancel the Song Move operation, press the EXIT button.
- Press the ENTER button once again to execute the Song Move operation.
The display will indicate “MoveTo BX” (X is the number of the blank area to which the song will be moved) for a time. When the song has been moved, the TOC will automatically be updated.

Tip: If you wish to record additional material to extend the length of an existing song, there must be a blank area following that song. If as shown in the following diagram, you have recorded song 1 and then recorded song 2 following it, there will be no blank area following song 1, and therefore it will not be possible to record additional material to extend the length of song 1. In such cases, you can move song 1 to blank area 1 so that additional material can be recorded onto the end of song 1.

Tip: Before performing the Song Move operation, it is a good idea to check Disc Information to see the arrangement of songs and blank areas. For details refer to page 86.

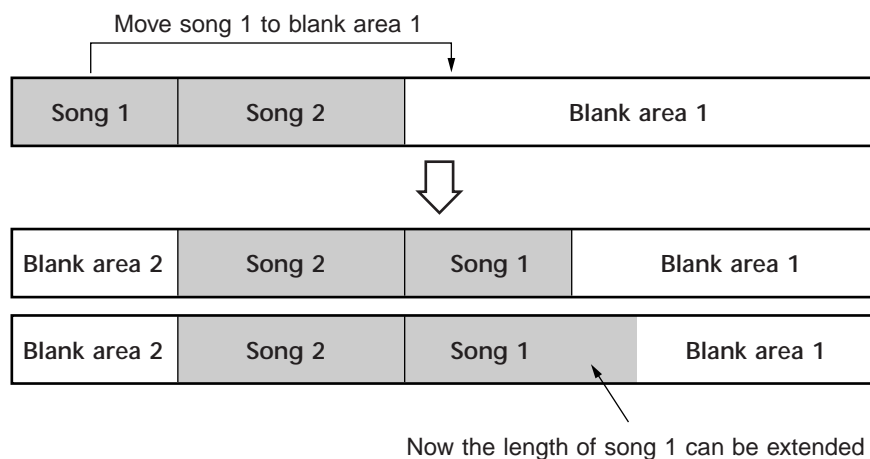

When a song is moved, its location on disc will change, but the song numbers will not be exchanged.

Exchanging the order of songs (Song Renumber)

Song Renumber is an operation that rearranges the numbers of the songs on disc. After you have used the Song Move operation, you can use the Song Renumber if you want the song numbers to match their sequence on disc.

Tip: To avoid confusion, we recommend that you assign a name to your songs before using the Song Renumber operation. See “*Titling discs and songs*” on page 85 for more information.

- Press the EDIT button, rotate the DATA dial to make the display read “Song Renum,” and press the ENTER button.
The display will ask “Renum EXE?” If you decide to cancel the Song Renumber operation, press the EXIT button.

2. Press the ENTER button to execute the Song Renumber operation.
When the songs have been renumbered, the TOC will automatically be updated.

Note: Some MD recorders other than the Yamaha MD4S, MD4 or MD8 divide the song data into multiple areas on the disc. Song Renumber cannot be used on such songs.

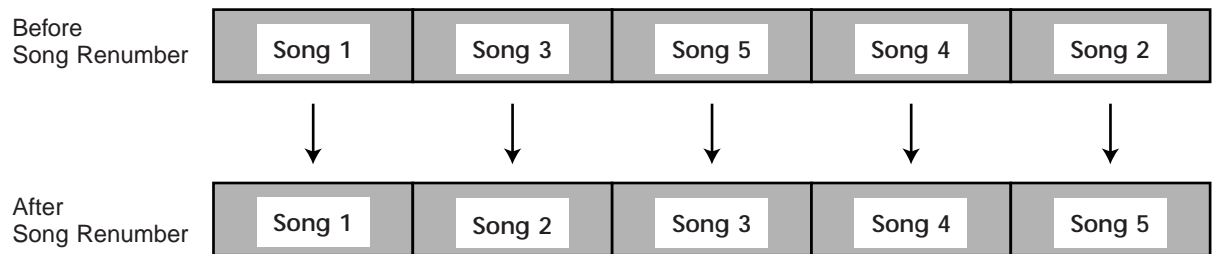

Other functions

The following pages explain other functions of the MD4S.

Adjusting the record/playback pitch (Pitch function)

The Pitch function lets you adjust the record/playback pitch. This is useful when you need to record an instrument that cannot be easily tuned (such as an acoustic piano) together with previously-recorded instruments.

The Pitch function is available when the MD4S is recording, playing, stopped, or paused.

Turning the Pitch function on/off

1. Press the PITCH button.

The display will indicate the Pitch setting. With the factory settings, the display will indicate “FIX +00.00%”

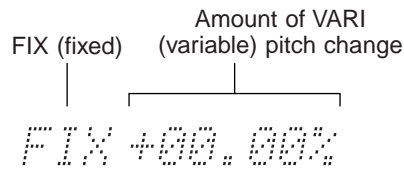

2. Rotate the CURSOR shuttle to turn the Pitch function on (VARI) or off (FIX).
 - FIX (fixed)**..... The display will blink “FIX,” and the FIX pitch indicator will light. The Pitch function will be turned off, and the pitch will be fixed at the normal setting.
 - VARI (variable)**..... The display will blink “+00.00%” and the VARI pitch indicator will light. The Pitch function will be on.

Adjusting the pitch

3. With VARI (variable) selected, rotate the DATA dial to adjust the amount of pitch change.

The pitch can be adjusted over a range of “-10.02%” to “+10.11%”. Lowering the pitch will slow down the recording/playback speed, and raising the pitch will speed up the recording/playback speed.

Note: At a setting of “+00.00%” the result is the same as when FIX is selected.

4. When you have finished setting the Pitch function, press the ENTER button to return to normal operation.

Note: The amount of pitch change for VARI (variable) is remembered even if the MD4S is turned off. However, the next time that the power is turned on, this function will automatically be set to FIX.

Note: After you use the Pitch function to record, don’t forget to return the setting to FIX (fixed) before the next recording. In particular, you should check the Pitch indicator before you start recording a new song.

Titling discs and songs

A title of up to 127 characters can be assigned to each disc and to each song on the disc. This provides a convenient way to distinguish discs and songs.

Titling a disc

1. Press the EDIT button, rotate the DATA dial to make the display read "Disc Name," and press the ENTER button.

If no title has been assigned to the disc, the display will blink "No Title."

2. Use the CURSOR shuttle to move to the location where you wish to input a character, and use the DATA dial to select the character.

The input location is shown by a blinking character (or a "■" character). The following characters are available.

A	B	C	D	E	F	G	H	I	J	K	L	M	N	O	P	Q	R	S	T	U	V
W	X	Y	Z	_	a	b	c	d	e	f	g	h	i	j	k	l	m	n	o	p	q
r	s	t	u	v	w	x	y	z	_	<	>	<	>	#	!	*	+	-	=	/	,
.	'	"	`	%	\$	&	!	?	#	_	0	1	2	3	4	5	6	7	8	9	_

(_ indicates a space)

Spaces can be inserted between characters.

3. When you have finished inputting the title, press the EDIT button once again to return to normal operation.
4. Press the TOC WRITE key to update the TOC.

Note: When a titled disc is inserted into the MD4S, the title will appear in the display for a time.

Titling a song

1. Use the SONG SEARCH buttons to select the song that you wish to title.
2. Press the EDIT button, rotate the DATA dial to make the display read "Song Name," and press the ENTER button.

The display will indicate the number and title of the selected song. If no title has been assigned, the display will blink "No Name." At this time you can rotate the DATA dial to select a different song number.

3. Rotate the CURSOR shuttle toward the right.
Now you will be able to input the song title.
4. Use the CURSOR shuttle to specify the location at which to input a character, and use the DATA dial to select a character.

The blinking character (or "■" character) indicates the input location. The available characters are the same as in the table shown above.

5. When you finish making settings, press the EDIT button once again to return to normal operation.

- Press the TOC WRITE button to update the TOC.

Note: When you use the SONG SEARCH buttons to select a song that already has a title, the song title will appear in the display beside the song number. However, only the first seven characters of the song title will be displayed.

Erasing a disc (Disc Erase)

Disc Erase is a function that erases all the songs on a disc. When you execute the Disc Erase function, the entire disc will be a blank area. Before a MD DATA disc that was used to store computer data can be used with the MD4S, you must first execute the Disc Erase operation on that disc.

- Press the EDIT button, rotate the DATA dial to make the display read "Disc Erase," and press the ENTER button.
The display will ask "Erase EXE?" If you decide to cancel the Disc Erase operation at this point, press the EXIT button.
- Press the ENTER button once again.
The display will ask "Really?" so that you can confirm the operation. You can cancel the Disc Erase operation by pressing the EXIT button.
- Press the ENTER button once again, and the Disc Erase operation will be executed.
When Disc Erase has been completed, the TOC will be updated automatically. The display will indicate "Blank Disc."

Viewing disc contents

The Disc Info function allows you to view how the songs and blank areas on a disc are organized. For example when you wish to record additional material onto the end of a song, you can use this function to check the available blank areas.

- Press the UTILITY button, rotate the DATA dial to make the display read "Disc Info," and press the ENTER button.
The display will show the order of songs and blank areas. Numbers indicate song numbers, and numbers prefixed by "B" are blank area numbers.

Song 1	Blank area 2	Song 3	Song 2	Blank area 1
--------	--------------	--------	--------	--------------

For example if you have executed the Song Move function so that songs and blank areas are arranged on the disc as shown above, the display will indicate the first two blocks as "1→B2→".

- Rotate the DATA dial to view the contents of the entire disc.
As you rotate the DATA dial toward the right, the display will indicate "1→B2→", "→B2→3", "→3→", "→2→B1" etc.

- Press the UTILITY button once again to return to normal operation.

Note: Some MD recorders other than the Yamaha MD4S, MD4 or MD8 divide the song data into multiple areas on the disc. When Disk Information for a disc including such songs is viewed on the MD4S, songs that are divided will be indicated by a “#” character. Songs that are indicated by “#” cannot be directly edited by the MD4S. However if you use the Song Copy function (page 76) to copy that song, the copy destination song can be edited by the MD4S.

Changing the recording mode

The MD4S allows you to choose from three recording modes: 4TR mode, 2TR mode, and MONO mode. When 2TR mode or MONO mode are selected, fewer tracks can be recorded, but the available recording time will be longer. There is no difference in audio quality between the modes.

Recording mode	Number of tracks	Available recording time (minutes)	MD DATA	MiniDisc
4TR (4 track recording)	1, 2, 3, 4	37	○	—
2TR (2 track recording)	1, 2	74	○	○
MONO (monaural recording)	1	148	○	○

Note: Set the recording mode before you begin a new recording. It is not possible to change the recording mode of an already-recorded song. You may change the recording mode for each song.

- Press the SONG SEARCH [▶▶] button to select a blank area.
The display will indicate “BLANK X” (X is the blank area number).
- Press the UTILITY button, rotate the CURSOR shuttle to make the display read “REC MODE,” and press the ENTER button.
The display will indicate the current recording mode.
- While watching the display, use the DATA dial to select the desired recording mode.

4TR MODE (4 track recording)

2TR MODE (2 track recording)

MONO MODE (monaural recording)

Note: If you select 2TR mode, recording will be possible only on tracks 1 and 2. If you select MONO mode, recording will be possible only on track 1.

- Press the ENTER button to finalize the recording mode.
- Press the UTILITY button once again to return to normal operation.

Note: 8TR mode songs that were recorded on the Yamaha MD8 cannot be edited on the MD4S. However, songs that were converted by the MD8 into 4TR/2TR/MONO modes can be played back by the MD4S.

Note: The recording mode setting is not reset when the power is turned off. If a recordable MiniDisc is inserted into the MD4S, it will automatically switch to 2TR mode, meaning that if you later insert an MD DATA disc and wish to perform 4 track recording, you will need to reset the recording mode to 4TR.

Adjusting the display brightness

The brightness of the display can be adjusted over five steps.

1. Press the UTILITY button, rotate the DATA dial to make the display read "Disp Dimmer," and press the ENTER button.
The display will indicate "Dimmer X" (X will be a number between 1–5).
2. Rotate the DATA dial to adjust the brightness.
The range of this parameter is 1–5, and higher settings will increase the brightness. The factory setting is 5.
3. Press the ENTER button to finalize the display brightness setting.
4. Press the UTILITY button or the EXIT button to return to normal operation.

Tip: This setting is remembered when the MD4S power is turned off.

Selecting the type of Frame display

The frame display of the display counter can be switched to either 86 frames/second (Mini-Disc/MD DATA audio frames) or 30 frames/second (MTC frames).

1. Press the UTILITY button, rotate the DATA dial to make the display read "Frame Disp," and press the ENTER button.
The display will indicate "XX Frame" (XX will be either 86 or 30).
2. Rotate the DATA dial to select either "86" or "30."
If "86" is selected, the "FRAMES" indicator will light in the Frame area of the time counter. If "30" is selected, the "MTC FRAMES" indicator will light.
3. Press the ENTER button to finalize the frame display setting.
4. Press the UTILITY button or the EXIT button to return to normal operation.

Tip: This setting is remembered when the MD4S power is turned off.

Using a Foot switch

If an optional FC5 foot switch is connected to the PUNCH I/O jack, you can use the foot switch to perform not only punch-in/out but a variety of other transport operations. When the foot switch is pressed, the MD4S will perform the following operations.

● On ✨ Flashing

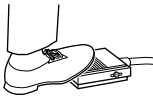
Mode Before					Mode After			
	Indicators			→		Indicators		
	REHE	REC	PLAY			REHE	REC	PLAY
Stop	—	—	—	→	Play	—	—	●
Play	—	—	●		Play Pause ¹	—	—	✨
Play Pause	—	—	✨		Play	—	—	●
Cue/Review	—	—	●	→	Play	—	—	●
Record Pause	—	✨	—		Play Record Wait	—	✨	●
Rehearse Pause	✨	—	—		Play Rehearse Wait	✨	—	●
Play Record Wait	—	✨	●	→	Record ²	—	●	●
Play Rehearse Wait	✨	—	●		Rehearse	●	—	●
Record	—	●	●	→	Play	—	—	●
Rehearse	●	—	●		Play	—	—	●
New Record Pause	—	✨	—	→	New Record	—	●	●
New Record	—	●	●		Stop ³	—	—	—
Auto Punch Record Standby	—	✨	—	→	Auto Punch Record Wait ⁴	—	✨	●
Auto Punch Rehearse Standby	✨	—	—		Auto Punch Rehearse Wait ⁴	✨	—	●

1. [PAUSE] button operation.
2. Effective only when a [REC SELECT] button is pressed.
3. [STOP] button operation.
4. After locating the Pre-Roll point, the Auto Punch In/Out sequence starts.

Note: For the optional Yamaha FC5 Footswitch, operation is initiated when the footswitch is pressed, not when it's released. This may differ, however, with other footswitches.

MIDI functions

The MD4S is an ideal device for recording vocals, guitar, or other acoustic instruments, but by using its MIDI functionality you can synchronize it with a MIDI sequencer or with another MD4S, or control the transport of the MD4S from an external MIDI device. This section explains how to use the MIDI functionality of the MD4S.

Synchronizing the MD4S with a MIDI sequencer

The MD4S allows you to select either “MTC” or “MIDI Clock” synchronization data for output from its MIDI OUT connector. This synchronization data can be transmitted to a MIDI sequencer to make the MIDI sequencer follow and synchronize to the MD4S. In this type of synchronized MIDI system, the MD4S will be the master and the MIDI sequencer will be the slave.

■ Connecting the MD4S with a MIDI system

The MD4S can be connected to a synchronized MIDI sequencer system in a wide variety of ways, but the most common setup is for acoustic sounds to be recorded on the MD4S, and other parts to be played by the sequencer on a MIDI tone generator. In such a system, you would monitor the sounds of the MIDI tone generator as you recorded vocals and guitar to the MD4S. Then during mixdown, you would mix the playback of the MD4S with the sound from the MIDI tone generator (See page 42).

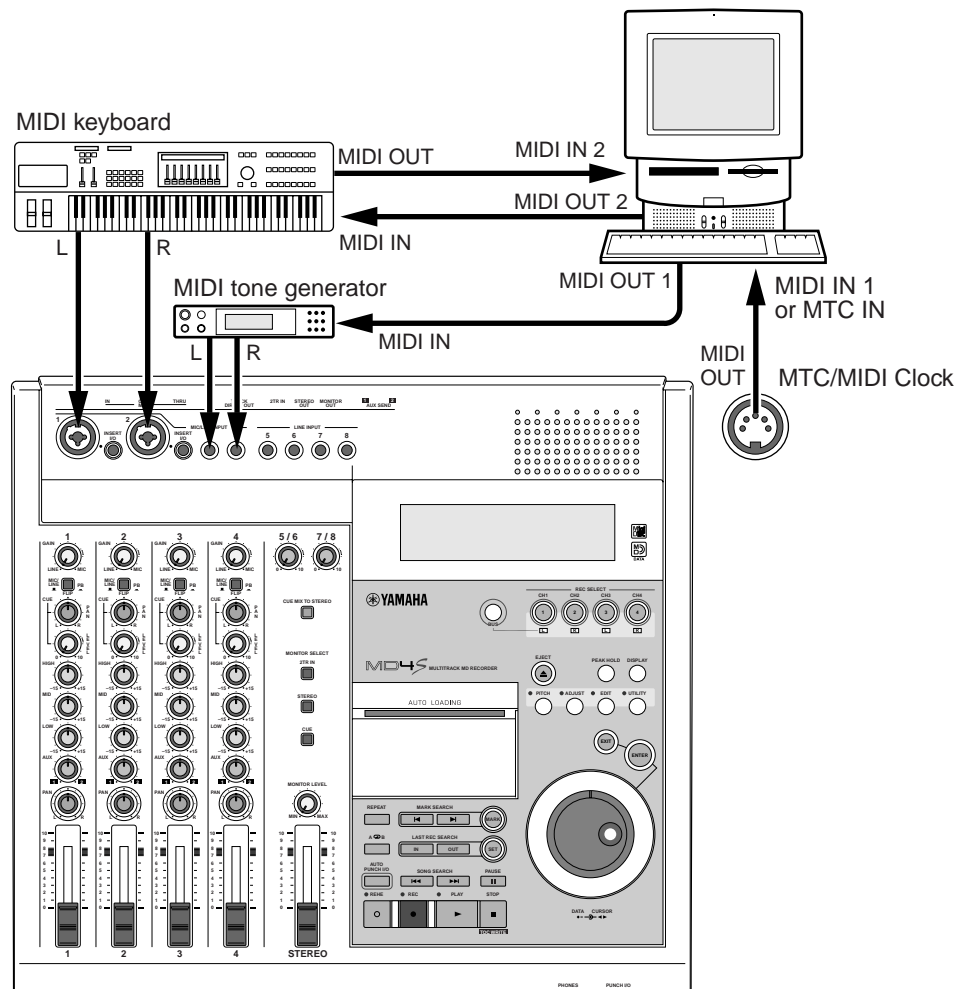

Note: When inputting MIDI Time Code sent from the MD4S to the MIDI sequencer, it is best to use a dedicated MTC input connector or a separate MIDI IN connector. The reason for this is that if MIDI musical (playback) data is sent together with MTC to the same MIDI IN connector of the sequencer, synchronization may be disrupted.

Tip: If your MIDI sequencer supports MMC (MIDI Machine Control), you can make the MD4S receive MMC data so that the principle transport functions of the MD4S can be controlled by the MIDI sequencer. Even in this case, the MD4S will still be the synchronization master of the MIDI system, but you will have the convenience of being able to control MD4S operations such as Record (including punch-in/out), Playback, and Locate to specified measures from the MIDI sequencer. For details on setting the MD4S to receive MMC, refer to “Controlling the MD4S by MMC” on page 98.

About MTC and MIDI Clock

MTC and MIDI Clock are different types of MIDI messages used for synchronization between MIDI devices.

MTC transmits absolute time information in units of a “frame” (1/30 of a second). If you start a MD4S song at the “5 minutes 10 seconds” location, the MIDI sequencer will also play in synchronization from the “5 minutes 10 seconds” location. Since the MIDI sequencer simply plays according to the time data that it receives, synchronization will not be affected if the tempo of the sequence data changes. Nearly all high-end computer-based sequencers support MTC.

MIDI Clock transmits Clock messages according to the tempo. In other words, the MIDI sequencer will synchronize to the Tempo data (tempo map) that was created on the MD4S. When you create a tempo map on the MD4S, the time display will indicate measures/beats/clocks just as on a MIDI sequencer. In this case if you start the MD4S song from “measure 10,” the MIDI sequencer will synchronize and start playing from “measure 10.” If you need to synchronize the MD4S to a MIDI sequencer or MIDI rhythm machine that does not support MTC, you should use MIDI Clock synchronization.

Note: If you are using MIDI Clock and the slave device does not support the MIDI Song Position Pointer message, it will not be possible to synchronize from the middle of the song. In this case, you must always start synchronizing from the beginning of the song.

Synchronization using MTC

■ Transmit MTC from the MIDI OUT connector of the MD4S

Make MIDI Sync settings so that the MIDI OUT connector of the MD4S will transmit MTC messages.

1. Press the UTILITY button, rotate the DATA dial to make the display read “MIDI Sync,” and press the ENTER button.
The display will indicate the currently selected MIDI Sync setting. If MIDI Sync is off, the display will indicate “Sync OFF.”
2. Rotate the DATA dial to make the display read “MTC MASTER.”
The MIDI indicator in the display will light to indicate “MTC SYNC MASTER.” With this setting, MTC messages will be transmitted from the MIDI OUT connector when the MD4S is running.
3. Press the UTILITY button once again to return to normal operation.

■ MIDI sequencer settings

To use MTC, your MIDI sequencer must be set to synchronize to the MTC messages it receives. In this case, you must set the frame rate to 30 frames/second. For details on making this setting, refer to the owner's manual of your MIDI sequencer.

Synchronization using MIDI Clock

■ Transmit MIDI Clock from the MIDI OUT connector of the MD4S

Make MIDI Sync settings so that the MIDI OUT connector of the MD4S will transmit MIDI Clock messages.

1. Press the UTILITY button, rotate the DATA dial to make the display read "MIDI Sync," and press the ENTER button.
The display will indicate the currently selected MIDI Sync setting. If MIDI Sync is off, the display will indicate "Sync OFF."
2. Rotate the DATA dial to make the display read "MIDI CLOCK."
The MIDI indicator in the display will light to indicate "MIDI CLOCK."
3. Press the UTILITY button once again to return to normal operation.

■ Programming a tempo map

Tempo and meter (time signature) data can be programmed into a MD4S song. For each song, you can program 26 steps (A–Z) each of tempo data and meter data, allowing you to change tempo and meter during the song.

Before you start programming a tempo map, it will be convenient to use the "Tempo Map Chart" on page 111 to make a note of the measures at which the tempo or meter changes.

1. Press the ENTER button, rotate the DATA dial to make the display read "Song Tempo," and press the ENTER button.
The display will indicate "Meter Setup" or "Tempo Setup."
2. Rotate the DATA dial to select "Meter" if you wish to program time signature data or "Tempo" if you wish to program tempo data. Then press the ENTER button.
The display will indicate "Edit Meter" or "Edit Tempo."
3. Rotate the DATA dial to make the display read "Edit" if you are editing an existing tempo map or "New" if you are programming a new tempo map. Then press the ENTER button.
The display will indicate step A at the first measure. The character "A" that indicates the step will be blinking.

When setting Meter
(time signature) data

	Step	Measure	Meter
STEP NO.	A	001	4/4

When setting Tempo data

	Step	Measure/beat	Tempo
STEP NO.	A	001-01	♩120

- Rotate the CURSOR shuttle to the right to select the meter/tempo parameter, and rotate the DATA dial to set the meter or tempo.

It is not possible to set the measure location of step A. The range of settings is as follows.

Meter 1–99/2, 4, 8, 16

Tempo ♩=20–300

- Press the ENTER button.
The character (A) that indicates the step will blink.
- Rotate the DATA dial to the right to select the next step (B).
- Use the CURSOR shuttle to select the measure at which the tempo map will be inserted and the meter/tempo parameters, and rotate the DATA dial to set the value.

For steps other than step A, setting the measure location to “000” will erase the tempo map that had been specified for that step.

- To specify a 3/4 time signature from measure 5, set “B 005 3/4”.
- To specify a tempo of “♩=90” from measure 10 beat 3, set “B010-3 ♩090”.
- To erase the current step “B012-3 ♩110”, set “B000-0 ♩110”.

- Press the ENTER button.
The step B meter data has now been inserted (or deleted, if you specified “000” as the measure location).
- Repeat steps 6–8 to continue programming the tempo map.
- Press the EDIT button once again to return to normal operation.
- Press the TOC WRITE button to update the TOC.

If you edited an existing tempo map, it is not necessary to update the TOC.

Note: The tempo map is saved independently for each song. When you select a song, the tempo map that has been programmed for that song will be loaded automatically. However, please be aware that the number of tempo maps that can be stored on a disc is limited, and will depend on the number of steps that have been programmed. If a display of “Save Warn!” appears when you update a tempo map, the disc area provided for tempo maps has been used up.

Note: A tempo map can be saved only on an MD DATA disc. It cannot be saved on a MiniDisc.

Tip: If the measure location of a new step is set earlier than the measure location of an existing step, the subsequent steps will automatically be reordered. Similarly if you set the measure location of an existing step to 000 to delete it, the subsequent steps will automatically be reordered.

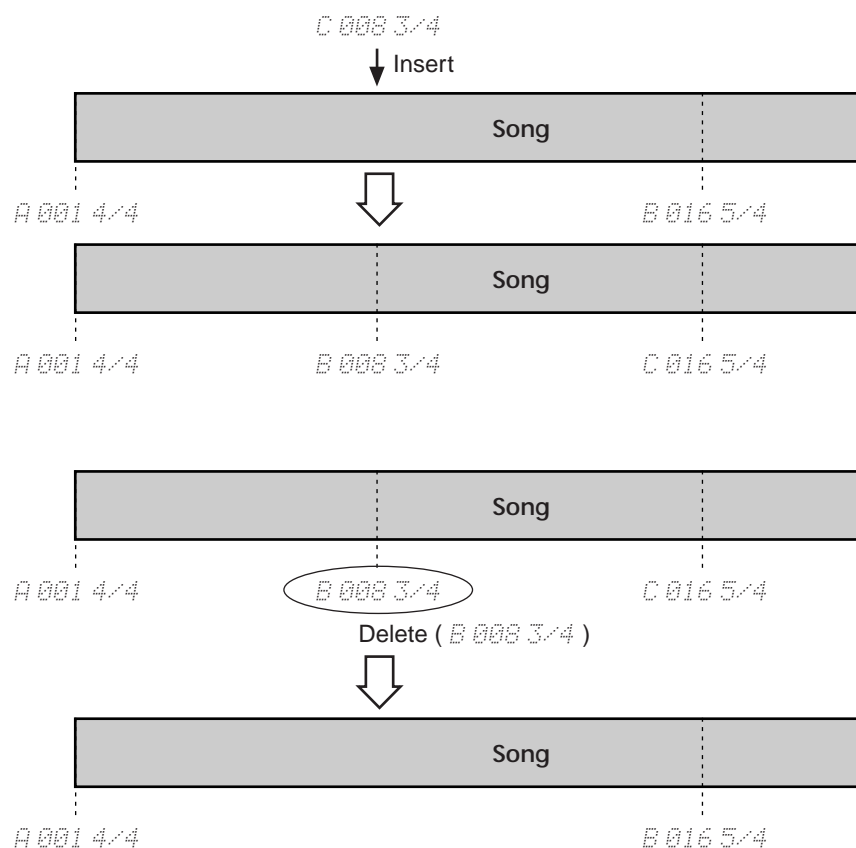

■ MIDI sequencer settings

When using MIDI Clock, you will need to make settings on your MIDI sequencer so that it will synchronize to MIDI Clock messages. For details on making this setting, please refer to the owner's manual of your MIDI sequencer.

Synchronizing two MD4S recorders

The MD4S is able to synchronize to MTC received from an external device. For example if you have two MD4S recorders, and set one MD4S to transmit MTC messages and the other MD4S to receive these MTC messages, the two units will act as a single 8-track multi-track recorder. In this case, the MD4S that transmits the MTC will be the MTC Master and the MD4S that receives the MTC will be the MTC Slave. When the MTC Master MD4S runs, the MTC Slave MD4S will follow the MTC Master and run in synchronization. In this setup, you can connect the STEREO OUT jacks of the MTC Slave MD4S to LINE INPUT jacks 5 and 6 of the MTC Master MD4S so that the signals of the ST bus of both units can be combined by the MTC Master MD4S.

Connect the two MD4S recorders as follows.

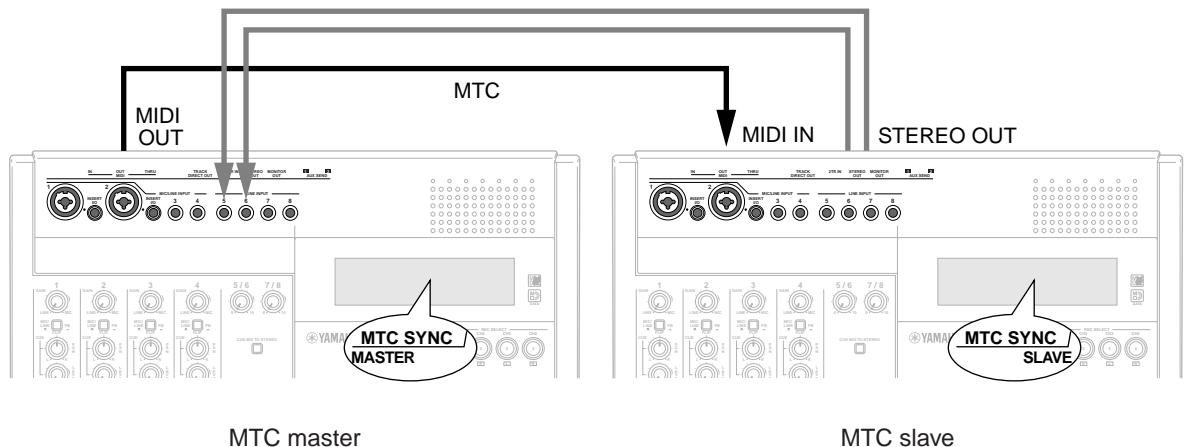

Tip: The MTC Master device can be a Yamaha MD8 or MD4 as well as another MD4S.

■ Settings for the MTC Slave MD4S

1. Press the UTILITY button, rotate the DATA dial to make the display read "MIDI Sync," and press the ENTER button.
The display will indicate the current MIDI Sync setting.
2. Rotate the DATA dial to make the display read "MTC SLAVE."
Set the master MD4S to indicate "MTC SLAVE."
3. Press the UTILITY button once again to return to normal operation.

Note: On the MD4S that is being used as the slave, the following buttons and functions cannot be used.

- MARK SEARCH buttons
- LAST REC SEARCH buttons
- PITCH button
- ADJUST button
- PAUSE button
- Locate to a specified time
- Shuttle playback
- Repeat playback
- Auto punch-in/out
- Punch-in/out using a foot switch
- MMC reception
- x1/2 playback

■ Synchronized recording on a slave MD4S

If you first put the MTC slave MD4S into Record-Pause mode, then you will be able to perform Record-Start and Pause operations from the MTC master MD4S.

1. On the slave MD4S, press a REC SELECT button or the BUS button + REC SELECT button to select the track(s) for recording.
2. Press the REC button of the slave MD4S.
The slave MD4S will enter record-pause mode. If you press the REHE button instead of the REC button, it will enter rehearsal-pause mode.

Note: When the slave MD4S is in record-pause or rehearsal-pause mode, its EDIT, UTILITY, and SONG SEARCH buttons cannot be used.

3. Start the master MD4S (playback/record/rehearsal).
The slave MD4S will receive the MTC messages, and will record/rehearse in synchronization with the location of the master.
4. When you press the STOP button on the master MD4S, the slave MD4S will also stop.

Tip: It is also possible to manually punch-in/out on the slave MD4S. In this case, press the PLAY button instead of the REC button in step 2, and then start the MTC master MD4S. When you reach the desired punch-in point, press the REC button of the slave unit. When you reach the punch-out point, press the PLAY button of the slave unit.

Note: The MTC slave MD4S will require a certain length of time after receiving MTC before it reaches a stable state of synchronization. If you will be recording on the MTC slave MD4S, start the master unit running (play/record/rehearsal) at least 10 seconds ahead of the location where you wish to begin recording. If you do not have sufficient time to start the song 10 seconds ahead of the recording location, you can use the Part Copy function (page 73) to move the entire song on the MTC master (or on both the MTC master and the MTC slave) approximately 10 seconds backward (i.e., toward the end).

Note: If the Pitch function of the MTC master MD4S is turned on, the MTC slave MD4S may be unable to synchronize accurately. As far as possible, please turn off the Pitch function of the MTC master.

Note: When you first record a new song on the MTC slave MD4S, you must begin synchronized operation from the beginning of the song (the “000:00:00” location) on the MTC master MD4S.

Note: The MTC slave MD4S is able to receive an MTC frame rate of 30 frames/second. If you are using a device other than an MD4S as the MTC master, you must set the frame rate to 30 frames/second.

Note: If you are synchronizing to an MTC master other than another MD4S (i.e., a MIDI sequencer etc.), you must use a dedicated MTC output connector on the MTC master, or output the MTC from a separate MIDI output connector. If MIDI playback data is merged with MTC data, the MTC slave MD4S may be unable to synchronize accurately.

■ Synchronized playback of a slave MD4S

If you first set the MTC slave MD4S to playback-pause mode, playback-start and pause operations can be performed from the MTC master MD4S.

1. Press the PLAY button on the slave MD4S.
The slave MD4S will enter playback-pause mode.
2. Start the master MD4S running (play/record/rehearsal).
The slave MD4S will receive MTC, and will begin playing in synchronization with the master MD4S.
3. Press the STOP button on the master MD4S, and the slave MD4S will return to playback-pause mode.
At this time if you start the master MD4S running, the slave MD4S will chase to the location of the master and will resume synchronized playback.

Synchronizing to MTC with a specified offset (time difference)

When using the MD4S as an MTC slave, you can assign an offset (time difference) that will be applied to the MTC time data received from the external device.

Note: The offset setting affects only the MTC slave MD4S. Even if you specify an offset for the MTC master MD4S, it will not affect the MTC that is transmitted from the MTC master.

1. If the MTC slave MD4S is in record/playback/rehearsal-pause mode, press the STOP button to defeat pause mode.
2. On the slave unit, press the UTILITY button, rotate the DATA dial to make the display read "MTC Offset," and press the ENTER button.

The display will indicate the current offset value as hours/minutes/seconds/frames. With the factory settings, this will read "00:00:00.00."

Hours	Minutes	Seconds	Frames
↓	↓	↓	↓
00:00:00.00			

3. Use the CURSOR shuttle to select the hours/minutes/seconds/frames parameters, and rotate the DATA dial to specify the value.

You can specify an offset in the range of "00:00:00.00" to "23:59:59.29."

For example if you specify an offset value of "00:01:00.00," an MTC master location of "00:01:00.00" will be considered by the MTC slave MD4S as a location of "00:00:00.00" (the display will indicate "00:00:00.00") for synchronization purposes.

If you specify an offset value of "23:59:00.00," an MTC master location of "23:59:00.00" will be considered by the MTC slave MD4S as a location of "00:00:00.00" (the display will indicate "00:00:00.00"), and an MTC master location of "00:00:00.00" will be considered by the slave as "00:01:00.00" (the display will indicate "00:01:00.00").

With an offset setting of "00:01:00.00"

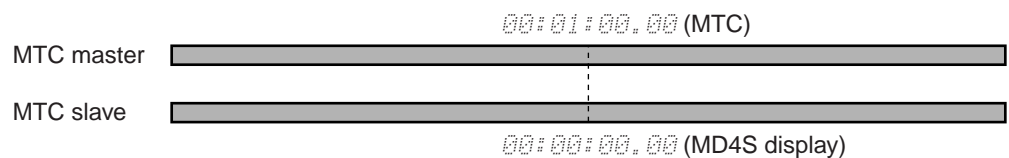

With an offset setting of "23:59:00.00"

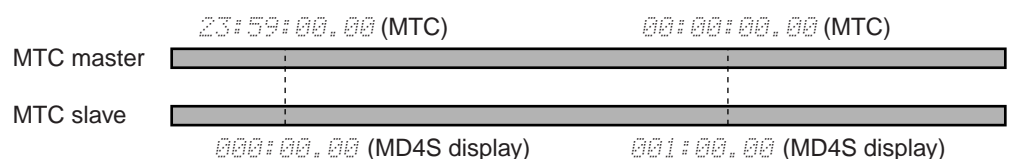

4. Press the UTILITY button to return to normal operation.

Controlling the MD4S by MMC

MMC (MIDI Machine Control) is a type of MIDI message that allows the transport of an audio/video recorder etc. to be controlled by an external MIDI device. Since the MD4S is able to receive MMC, an MMC-compatible MIDI sequencer or other device can control the transport of the MD4S. In this case, the device that transmits MMC data will be the MMC Master, and the device that receives MMC data will be the MMC Slave.

The MD4S supports the following MMC messages.

Function	MMC#	MD4S operation
Stop	Command 01	If this command is received during recording, rehearsal, or playback etc., that operation will be halted.
Playback	Command 02, 03	When this command is received, playback will begin. If this command is received during recording or rehearsal, that operation will be halted.
Fast-forward	Command 04	Skip to the next song. If this command is received during recording or rehearsal, that operation will be halted.
Rewind	Command 05	Skip to the previous song. If this command is received during recording or rehearsal, that operation will be halted.
Record Strobe	Command 06	If this command is received when stopped, recording will begin. If this command is received during playback, punch-in will be performed. If received while paused, this command will be ignored.
End Record	Command 07	Record mode will be turned off.
Pause	Command 09	Enter pause mode. If received during record or rehearsal, stop.
MMC Reset	Command 0D	Reset MMC data to the initial settings (the condition at power-on).
Write	Command 40	Write data to the specified data field.
Locate	Command 44	Locate to the specified time code location.
Record Mode	Data field 4C	Switch between REHE and REC.
Track Record Ready	Data field 4F	Select the track to be recorded by "Record Strobe."

■ Switching MMC reception on/off

You can specify whether or not the MD4S will receive MMC.

1. Press the UTILITY button, rotate the DATA dial to make the display read "MMC Receive," and press the ENTER button.
The display will indicate the current MMC reception setting. With the factory settings this is off, and the display will indicate "MMC Rx OFF."
2. Rotate the DATA dial to switch the setting "ON" or "OFF."
When this is "ON," MMC can be received.
3. Press the ENTER button to confirm the setting.

4. Press the UTILITY button or the EXIT button to return to normal operation. If MMC reception was turned on, the MD4S will be the MMC Slave, and can be operated by MMC messages received from the external device.

Tip: This setting is remembered even if the power is turned off.

■ Setting the MMC Device ID

If there is more than one MMC slave, a single command will control all MMC slaves since MMC commands are common to all devices. However in some cases (such as when specifying the tracks for recording), you may wish to control only a specific MMC slave device. In such cases, you can set the MMC Device ID so that the MMC master will control only a specific MMC slave device.

1. Press the UTILITY button, rotate the DATA dial to make the display read "MMC Dev ID," and press the ENTER button.
The display will indicate the currently selected Device ID. With the factory settings, the Device ID is set to 1, and the display will indicate "DEV ID 1."
2. Rotate the DATA dial to select the Device ID (1–127).
3. Press the ENTER button to confirm the selection.
4. Press the UTILITY button or the EXIT button to return to normal operation.

Note: Set the MMC Master device so that it will transmit MMC to the ID you specified here.

Tip: This setting is remembered even if the MD4S is turned off.

Appendix

Q&A Section

This section is intended to answer your questions about the MD4S and MD DATA discs.

What's the difference between MiniDiscs and MD DATA Discs?

MiniDiscs were designed to store mono and stereo sound data. MD DATA discs were originally designed to store computer data. Ideal for use with digital cameras. However, they can also be used to store mono, stereo, and four-channel sound data. That's how MD4S uses them.

Can the MD4S use normal MiniDiscs?

Yes, but only for 2-track or mono recording and playback. MiniDiscs recorded on the MD4S can be played on normal MiniDisc decks.

Are Yamaha MD8 and MD4 discs compatible with the MD4S?

All discs recorded on the Yamaha MD4 can be used by the MD4S. Discs recorded on the Yamaha MD8 can be used by the MD4S if they are converted by the MD8 to 4TR mode.

What happens if I insert an MD DATA Disc into a MiniDisc deck?

The disc will not be recognized. MiniDisc decks cannot use MD DATA discs.

How long is the life of an MD DATA disc?

So long as the disc is not damaged physically, it has an infinite life span. Even after one million record and playback operations there is no signal degradation.

Do I need to format an MD DATA Disc before recording with the MD4S?

Yes and no. The MD4S uses MD DATA discs straight out of the wrapper. No fuss. An MD DATA disc that has been used to store computer data, however, must be erased before use with MD4S.

What is the available recording time?

This depends on the Recording mode: 37 minutes for four-track (4TR), 74 minutes for stereo (2TR), and 148 minutes for mono (MONO).

What is the frame counter?

A frame is an integral part of the MD DATA disc format. One frame can hold 11.6 ms of data (i.e., 512 samples of ATRAC sound data at 44.1 kHz). There are approximately 86 frames to a second. Using the FrameDisp function you can select between 86 (MD) and 30 (MTC) frames per second.

Is the sound quality affected by repeated ping-pong operations?

No—thanks to digital recording technology. Note, however, that the MD4S mixer is analog, so after many ping-pong operations slight signal degradation may occur, although this is still insignificant when compared to tape-based analog recorders.

Do I have to sacrifice one track to record timecode?

No. The MD4S generates MTC (MIDI Timecode) or MIDI Clock from the disc's internal sync signals. So even in a synchronized MIDI system, all eight tracks are available for sound recording.

How many songs can I store on an MD DATA disc?

Up to 254.

Do I have to clean the MD4S heads?

No.

Troubleshooting

If you're having difficulty operating the MD4S or if it doesn't seem to work as expected, look up the symptoms in the following table and follow the advice provided.

Symptom	Advice
The MD4S cannot be turned on!	Make sure the power cord is connected to a suitable AC wall outlet and plugged into the AC IN connector at the rear of the MD4S.
	Make sure that the MD4S POWER switch is set to the ON position.
	If you still cannot turn on your MD4S, contact your Yamaha dealer.
Cannot listen to a connected music source!	Make sure that the MONITOR LEVEL control is raised, and that the FLIP switches and MONITOR SELECT switches are set appropriately. If the FLIP switch is in the "MIC/LINE (■)" position, raise the fader of the corresponding input channel and the STEREO fader, and turn on the MONITOR SELECT STEREO switch. If the FLIP switch is in the "PB (■)" position, raise the CUE LEVEL control of the corresponding input channel and the STEREO fader, and turn on the MONITOR SELECT CUE switch.
Cannot record four tracks!	Are you using a MiniDisc? Please use MD DATA discs.
	Make sure that the 4TR recording mode is selected.
Cannot record!	Make sure the disc's write protect tab is set to unprotect.
	Make sure that the x1/2 Play function is not on.
	Press a REC SELECT button, or the BUS button + REC SELECT button, and make sure that the track is ready to record.
	Make sure that the signal that you wish to record has been selected as the recording source for the appropriate track. Use the CUE LEVEL control to check whether the signal is actually being sent to the track.
Cannot rehearse!	You cannot rehearse the first recording on a blank disc or blank area. Record something first, then use the Rehearse function.
The level meters do not indicate signal levels!	Press a REC SELECT button, or the BUS button + REC SELECT button, and make sure that the desired track is ready to record. Next, press the REC button or the REHE button, and make sure that the MD4S is in record-pause or rehearsal-pause mode.
Cannot use the Auto Punch In/Out function!	Make sure that the track you wish to record has been selected.
	Make sure that the auto punch-in/out points have been specified. If they have been specified, the IN and OUT point indicators will be lit.
	Make sure that the auto punch-out point has not been set at a location that is earlier than the auto punch-in point.

Symptom	Advice
Cannot use the punch-in/out or ping-pong recording function!	In some cases, punch-in or ping-pong recording may not be possible on a song that was edited on an MD recorder other than the MD4S or the Yamaha MD8/MD4. Use the Song Copy function to copy the song, and perform the punch-in/out or ping-pong recording operation on the copy.
	If the song was recorded on an MD recorder other than the MD4S or the Yamaha MD8/MD4, it is possible that the song may be copy-protected (by SCMS). In this case, it will not be possible to perform punch-in or ping-pong recording.
Recordings play back at the wrong pitch!	Make sure that the Pitch function is not set to VARI.
	Make sure that the 1/2 Play function is turned off.
Cannot use Part Copy or Part Erase!	Make sure that the Last Record In/Out points have been set. If they have been set, the IN/OUT point indicators will light.
	Make sure that the Last Record Out point has not been set in a location earlier than the Last Record In point.
The signal of the input channel is not output from the AUX SEND jacks!	Rotate the AUX control toward 1 or 2, and raise the channel fader. Since the signal sent to the AUX SEND jacks is post-fader, no signal will be sent to the AUX SEND jacks unless the channel fader is raised.
Cannot play the Cue List!	Make sure not all steps in the Cue List are set for zero repeats (n=0).
	Make sure that the specified ranges within the cue list are correct.
	Make sure that no non-existent markers are selected in the cue list.
MIDI sequencer does not synchronize to the MD4S!	Make sure that your MIDI sequencer supports MTC or MIDI Clock.
	Make sure that the MIDI sequencer has been set to synchronize to incoming MTC or MIDI Clock messages.
	If you are using MIDI Clock, make sure that a tempo map has been programmed in the MD4S. (If the measure/beat display does not appear when you press the DISPLAY button, a tempo map has not been set.)
	Make sure that the MD4S has been set to transmit MTC or MIDI Clock messages from its MIDI OUT connector. When MTC is being transmitted, the MTC SYNC MASTER indicator will light. When MIDI Clock is being transmitted, the MIDI CLK indicator will light.
	Make sure that X1/2 Play is turned off. If X1/2 Play is on, synchronization is not possible.
	If you are using a Repeat function such as A-B Repeat, some time may be required for the MIDI sequencer to synchronize during a repeat, due to the slowness of the MD4S locate function.

Display Messages

Message	Meaning
ADJST Stop	The STOP button was pressed, so the Adjust function was cancelled.
BLANK X	The MD4S is located at the Blank Top position.
Blank Disc	The disc is blank.
Can't Comb	MD4S cannot combine these two songs because they were not split using the Song Divide function, or MD4S cannot edit this type of song.
Can't Copy	This song cannot be copied because it's copy protected.
Can't REC	The MD4S cannot record over this type of song, so you cannot overwrite this song.
Can't Rehe	The MD4S does not have permission to record in this mode, so you cannot rehearse a recording that would overwrite this song.
CLK OFF!	MIDI Clock was turned OFF automatically because you selected the Program Play or Cue List function.
Copy Stop	The STOP button was pressed, so the Song Copy, Track Copy, Part Copy, or Cue List Copy function was cancelled.
DiscErr xx	A disc scratch or defect was discovered while recording. Replace the disc.
Disc FULL	The disc is full. You cannot record any more data or additional takes (Multi Take Auto Punch In).
Erase Stop	The STOP button was pressed, so the Track Erase or Part Erase function was cancelled.
Erase Warn!	This song has been write protected by another recorder. Press the ENTER button to erase or the EXIT button to cancel.
Error xx	A fatal error occurred. Contact your Yamaha dealer.
IN/OUT Err	The IN or OUT point is not valid, so you cannot use Auto Punch In/Out.
InvalidSong	Since this song is not compatible with the MD4S, it cannot be played.
List Error	The cue list is invalid.
MARK Failed	No more markers can be inserted because the song contains the maximum of eight, or you tried to insert a marker at the position of an existing marker.
Move Stop	The STOP button was pressed, so the Song Move function was cancelled.
MTC OFF!	MTC was turned OFF automatically because you selected the Program Play or Cue List function.
No Blank	No blank area can be found for further recording.
No Disc	No disc is loaded.
PNCH Abort	Because the STOP button was pressed, the off-line punch-in/out function was aborted.
Protected	The disc's write protect tab is set to protect, so you cannot record.
Reading TOC	The MD4S is reading the TOC from disc.
Reload Disc	The MD4S is waiting for you to reload the disc.
Save Warn !	Not all the Tempo Map steps can be saved because the data area is full.
UTOC FULL	The TOC area is full, so not all of the song title or Tempo Map could be saved.
Writing TOC	The MD4S is writing the TOC to disc.

Modes of the MD4S transport

● On ✱ Flashing

Mode	Indicators			MD4S operating Status
	REHE	REC	PLAY	
Stop	—	—	—	No activity.
Play	—	—	●	Normal playback
Play Pause	—	—	✱	Playback is paused.
Cue FF	—	—	●	High-speed playback at 1/2 speed or 2X, 4X, 8X, 16X or 32X speed.
Review	—	—	●	High-speed reverse playback at 2X, 4X, 8X, 16X or 32X speed.
Record Pause	—	✱	—	Recording is paused.
Record	—	●	●	Recording in progress.
Rehearse Pause	✱	—	—	Rehearsal is paused.
Rehearse	●	—	●	Rehearsal in progress.
New Record	—	●	●	A new song is being recorded.
New Record Pause	—	✱	—	New song recording is paused.
Auto Punch Record Standby	—	✱	—	The Auto Punch In/Out function has been activated and the MD4S is standing by to start the Auto Punch recording sequence.
Play Record Wait	—	✱	●	The Auto Punch recording sequence has started and is currently between the Pre-Roll point and the Punch IN point.
Auto Punch Rehearse Standby	✱	—	—	The Auto Punch In/Out Rehearse function has been activated and the MD4S is standing by to start the Auto Punch rehearsal sequence.
Play Rehearse Wait	✱	—	●	The Auto Punch rehearsal sequence has started and is currently between the Pre-Roll point and the Punch IN point.

Specifications

Recorder

Digital/Audio	Sampling Frequency: 44.1 kHz	Compression: ATRAC
	Frequency Response: 20 Hz–20 kHz, +1 dB, –3 dB	
	THD+N: Less than 0.02% (1 kHz)	
	S/N: 96 dB typ.	
Rec/Play	4-track independent simultaneous record/play (Recording time: 37 min)	
	Dubbing with 4-track playback	
	Auto & Manual Punch In/Out (11.6 ms accuracy)	
	Four-track (37 min), Stereo (74 min), or Mono (148 min) record/play	
	Repeat play A-B, Single song, All song	
	Vari-pitch ($\pm 10\%$)	
Locate	Start and End point of Song	Direct Time Locate
	10 Marker locate points for each song	Last Recording In/Out point
Cue & review	0.5x, 2x, 4x, 8x, 16x, 32x play speed	
Disc Editing	Disc Erase	
Song Editing	Copy, Move, Divide, Combine, Renumber, Erase	
Track Editing	Track Copy, Part Copy, Track Erase, Part Erase	
Title Editing	Disc title, Song title	
Panel Controls	REC SELECT buttons 1–4, BUS button	
	Transport buttons: PLAY, STOP, PAUSE, REC, REHE, SONG SEARCH, EJECT	
	Mode buttons: AUTO PUNCH I/O, EDIT, UTILITY, ADJUST, PITCH, PEAK HOLD, DISPLAY, EXIT	
	CURSOR shuttle/DATA dial	
	Locate buttons: MARK, MARK SEARCH, LAST REC (IN/OUT), SEARCH, SET, REPEAT, A↔B	
MIDI	MIDI IN, OUT, THRU jacks	
Display	FLD (Fluorescent Display)	

Mixer

Inputs	MIC/LINE IN (CH1, 2)	Balanced phone jack x2 (–10 to –50 dB)
	MIC/LINE IN (CH1, 2)	Balanced XLR x2 (–10 to –50 dB)
	MIC/LINE INPUT (CH3–4)	Unbalanced phone jack x2 (–10 to –50 dB)
	LINE INPUT (CH5–8)	Unbalanced phone jack x4 (–10 dB)
	INSERT IN/OUT (CH 1, 2)	TRS phone jack x2 (–10 dB)
	2TR IN (L, R)	Phono x2 (–10 dB)
Outputs	TRACK DIRECT OUT (1–4)	Phono x4 (–10 dB)
	STEREO OUT (L, R)	Phono x2 (–10 dB)
	MONITOR OUT (L, R)	Phono x2 (–10 dB)
	AUX SEND (1, 2)	Phone jack x2 (–10 dB)
	PHONES OUT	Stereo phone jack (8–40 Ω)
Frequency response	20 Hz–20 kHz +1, –3 dB	
EQ	3-band, ± 15 dB (LOW: 100 Hz shelving, MID: Peaking (2.5 kHz), HIGH: 10 kHz Shelving)	
MASTER Channel Features	Stereo Fader (45 mm), Monitor Level control, Monitor Select buttons (2TR IN, STEREO, CUE), CUE MIX TO STEREO buttons	

0 dB is referenced to 0.775 V r.m.s.

General

Power Requirements	USA & Canada: 120 V/60 Hz, Others: 230 V/50 Hz
Power Consumption	24 W
Dimensions (W x H x D)	413 x 109.5 x 388 mm
Weight	5.2 kg
Operating Conditions	Temperature: 5°C–35°C (41°F–95°F), Humidity: 10%–95%
Supplied Accessories	AC power cord, <i>Owner's Manual</i>
Optional Accessories	FC5 Footswitch

Dimensions

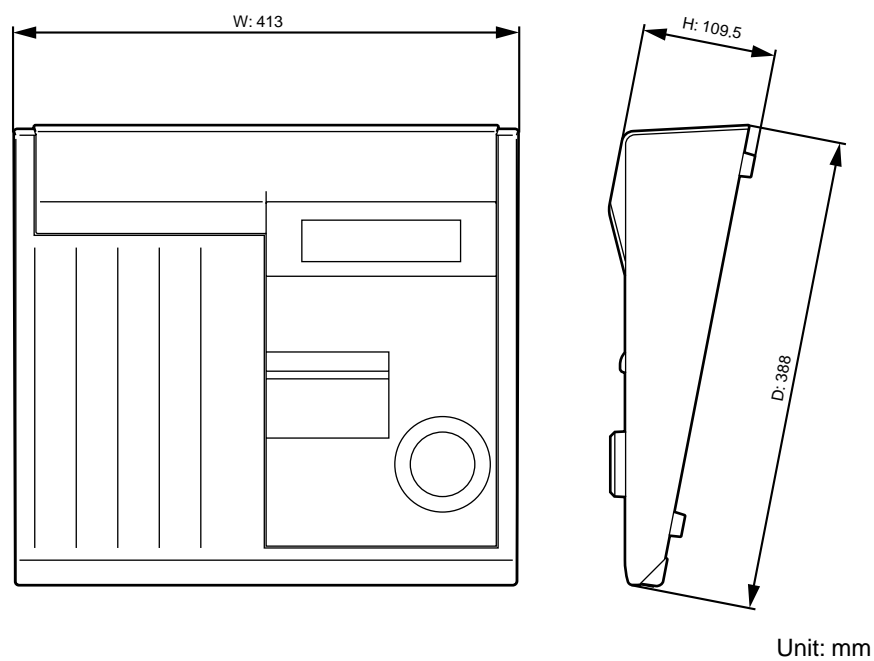

Specifications subject to change without notice.

Block Diagram

* MIC/LINE INPUT jacks 1 and 2 accept either phone or XLR plugs.
Only one plug can be inserted in each jack.

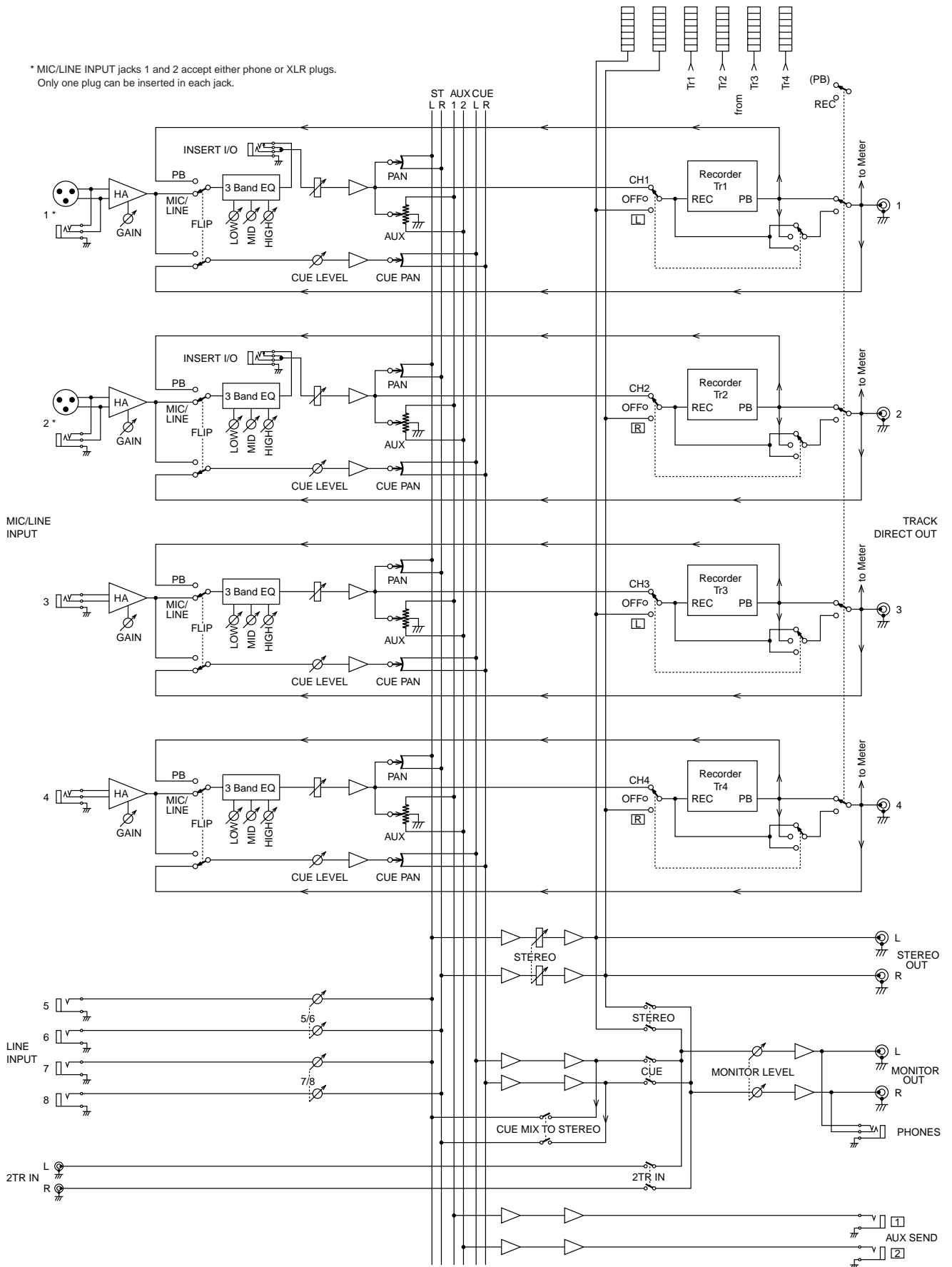

Glossary

This section explains the technical terms used in this owner's manual.

ATRAC—An acronym for Adaptive Transform Acoustic Coding. This is the compression technique used to fit the same amount of data as that of a 120 mm CD on a 64 mm MiniDisc. Using the ATRAC system, the MD4S provides an 4-track recording time of 37 minutes. ATRAC uses established psychoacoustic principles to compress audio data to approximately one-fifth of its original size, with virtually no loss in sound quality. The *threshold of hearing* principle states that the sensitivity of the human ear is frequency dependent. Two tones of the same level but at different frequencies will not be heard at the same loudness. Another principle used is the *masking effect*. That is, softer sounds become inaudible when louder sounds at similar frequencies are present.

Bus—A “bus” is a route for audio signals to which the signal from each input channel can be distributed, and which can be sent to its own output jack. The MD4S has the following buses.

ST bus: Input channel signals are mixed in stereo to the stereo bus, and output from the STEREO OUT jacks.

CUE bus: Signals from each input channel and the track playback are mixed in stereo to the Cue bus, and output from the MONITOR OUT jacks and the PHONES jack. The output signal of this bus is mainly used to monitor signals during recording.

AUX bus: Signals from each input channel are mixed in monaural to the AUX buses, and output from the AUX OUT jacks. The output signal of these buses are mainly used as sends to external effect processors, etc.

Clipping—The unwanted distortion effect of overloading an audio circuit with a signal that is too large. Care must be taken when setting the MD4S GAIN controls so as not to overload the recording circuits. See “*Recording the first track (Direct Recording)*” on page 26.

Cue List—The Cue List function allows you to compile a cue list (i.e., a sequence of cues for playback) using markers. Cues are loaded into memory for continuous, uninterrupted playback. A new song can be created from the Cue List using the Cue List Copy function. See “*Cue List playback*” on page 68 for more information.

DAT—An acronym for Digital Audio Tape. DAT recorders are especially popular in recording studios for recording the final stereo mix.

EQ—An acronym for an audio equalizer. The MD4S input channels feature three-band EQ.

Foot switch—A foot operated switch. Several MD4S transport functions and the punch in/out function can be controlled using an optional footswitch.

Frame—An integral unit of the MD DATA disc format. One frame can hold 11.6 ms of data (i.e., 512 samples of ATRAC sound data at 44.1 kHz). There are approximately 86 frames in a second. Using the FrameDisp function you can select between 86 (MD) and 30 (MTC) frames per second.

Input channel—An “input channel” is a section of the mixer that individually processes an input signal. After a signal is input to an input channel, it is sent through the EQ to adjust its tone, its volume level is adjusted, and then it is routed to a variety of output jacks.

Locate—To “locate” means to move to a specific point in the song. The MD4S provides a variety of Locate functions that allow you to jump instantly to the desired location. See “*Quick search functions*” on page 61 for more information.

MD DATA—A compact data storage medium designed to store computer-type data. Although similar to MiniDiscs, they are not interchangeable. MD DATA discs come in two varieties: playback only and rewritable. MD4S uses the rewritable type for recording. See “*Buying discs for the MD4S*” on page 10 for more information.

MIDI—An acronym for Musical Instrument Digital Interface. An internationally agreed standard that allows electronic musical instruments and audio equipment to communicate.

MIDI Clock—A clock signal transmitted as MIDI data. MIDI Clock refers to a timing signal and Start, Continue, and Stop commands. The MD4S can supply MIDI Clock to a MIDI sequencer for synchronized operation.

MIDI Song Position Pointer—A type of MIDI message that is used to derive position information from a MIDI Clock signal. The MD4S generates MIDI Song Position Pointers. So no matter where you start playback in a song, your MIDI sequencer will locate to that point and then play along in synchronization.

MIDI Timecode (MTC)—An addition to the MIDI Standard that allows audio equipment to be synchronized. MIDI Timecode contains clock and position information. MD4S can supply MTC to a MIDI sequencer for synchronized operation.

MiniDisc—A compact data storage medium designed to store music. MiniDiscs come in two varieties: playback only and recordable. MiniDiscs can only be used for 2-track or mono recording with the MD4S. MiniDiscs recorded on the MD4S can be played on a normal MiniDisc deck. *See also* Random Access, ATRAC, and MD DATA Disc.

Mixdown—“Mixdown” (also called “track-down”) is the process of mixing two or more previously-recorded tracks into a stereo mix, and recording the result on an external master recorder.

Monitor CUE—The cue monitor allows you to monitor individual tracks as they are being recorded or played back. In Record Pause mode and during recording, the CUE monitor source is the signal being recorded (i.e., the input signal). For playback the CUE monitor source is from disc (i.e., the signal that was recorded to disc). This is useful with the punch in/out functions, because you can monitor the recorded signal up to the specified IN point, and then the new signal that’s being recorded up to the OUT point.

Overdub Recording—“Overdubbing” is the process of recording a new performance while monitoring other previously-recorded tracks.

Panning—A technique used to position sounds in a stereo mix.

PB—An abbreviation for Playback. This abbreviation appears next to the input selector switch on each input channel and is used to select the disc signal as the source for the input channel.

Phone Jack—A 1/4-inch socket commonly used on audio equipment.

Phono Jack—Also known as an RCA jack, this type of connector is often used on semiprofessional audio and video equipment.

Ping-Pong—“Ping-pong” recording is the process of mixing two or more previously-recorded tracks, and re-recording the mix to one or two other tracks.

Pre-Roll Time—For Auto Punch In/Out, this is the time before the IN point at which playback starts. *See “Setting the pre-roll/post-roll times” on page 55 for more information.*

Post Fader—A point in the signal path after a fader. The signals for the MD4S AUX controls are sourced post-fader. So as well as turn up the AUX control, you must also raise the fader. This has the advantage that the level of the processed signal from the external effects processor depends on the level of the unprocessed signal that is controlled by the fader.

Post-Roll Time—For Auto Punch In/Out, this is the time after the OUT point at which playback stops. *See “Setting the pre-roll/post-roll times” on page 55 for more information.*

Punch In/Out—A recording technique that allows you to rerecord specific sections of an existing track. The MD4S provides both manual and automatic punch in/out operations.

Random Access—The ability to access data instantly. The MD4S quick locate functions allow you to locate any point instantly. Tape-based recorders do not have random access capabilities because they have to wind a tape, which takes time.

SCMS (Serial Copy Management System)—A protection system intended to prevent illegal copying of music. SCMS allows one-time serial copying of copy-protected material. If the source is not copy protected, it's possible to make any number of digital-to-digital copies of the material. If the source is copy protected, however, it's possible to make a first-generation copy, but further copies cannot be made from the first-generation copy. SCMS is only effective when copying via digital connections. Recordings made via analog connections are not affected.

Signal to Noise Ratio (S/N)—In an audio system, the difference between the nominal signal level and the residual noise floor, usually expressed as a ratio in decibels. It's used as a measure of an audio system's noise performance.

Tempo Map—A map containing the tempo and meter information for a song.

TOC—An acronym for Table Of Contents. An area of the MD DATA disc used to store information about what is recorded on the disc, the disc title, song titles, and so on.

Tracking—A "track" is an area used to record and playback an individual audio signal. The MD4S has four tracks, each of which can be recorded/played independently. Recorders like the MD4S which have multiple tracks are called "multi-track recorders" (MTR).

Unity Gain—A gain of one. That is, the signal is output from a circuit at the same level at which it entered. Once passed the MIC/LINE amplifier, a unity gain system minimizes signal noise and distortion. The unity gain position for the MD4S faders is at the 7–8 mark.

Tempo Map Chart

Meter		
Step	Measure	Time Signature
A	001	/
B		/
C		/
D		/
E		/
F		/
G		/
H		/
I		/
J		/
K		/
L		/
M		/
N		/
O		/
P		/
Q		/
R		/
S		/
T		/
U		/
V		/
W		/
X		/
Y		/
Z		/

Tempo		
Step	Measure -Beat	Tempo
A	001-1	
B		
C		
D		
E		
F		
G		
H		
I		
J		
K		
L		
M		
N		
O		
P		
Q		
R		
S		
T		
U		
V		
W		
X		
Y		
Z		

MIDI Implementation Chart

Function...	Transmitted	Recognized	Remarks
Basic Channel	Default X Changed X	X X	
Mode	Default X Messages X Altered *****	X X X	
Note Number	True Voice X *****	X X	
Velocity	Note On X Note Off X	X X	
After Touch	Keys X Ch's X	X X	
Pitch bend	X	X	
Control Change	X	X	
Prog Change	:True# X *****	X X	
System Exclusive	X	O	*1
System Common	:Song Pos O :Song Sel X :Tune X	X X X	*2
System Real Time	:Clock O :Commands O	X X	
Aux Messages	:Local ON/OFF X :All Notes OFF X :Active Sense X :Reset X	X X X X	
Notes	MTC quarter frame messages are received in MTC Sync slave mode MTC quarter frame messages are transmitted in MTC Sync master mode. *1: MMC *2: During MIDI Clock synchronization		

Index

Numerics

2TR IN jacks 23
2-track (2TR) 11
4-track (4TR) 11

A

A \curvearrowright B button 68
A-B Repeat 68
A \curvearrowright B repeat button 17
AC IN 23
Adding sounds during mixdown 42
ADJUST button 18, 63, 65
Advanced recording techniques 35
All Song Repeat 67
Applying an effect during ping-pong recording 48
Applying an effect only to the monitor signal 50
Applying effects 44
Applying effects during mixdown 47
ATRAC 108
AUTO PUNCH I/O button 17
Auto punch indicator 21
auto punch-in point 55
auto punch-in/out 55, 56, 58
auto punch-in/out points 62
auto punch-out point 55
AUX bus 108
AUX control 14
AUX SEND 1, 2 jacks 23
AUX SEND jacks 46

B

backward (review) 66
blank area 12, 27
Bus 108
BUS button 17

C

Check the recording level 27
Clipping 108
CUE bus 108
Cue List 68, 69, 70, 108
cue mix function 15, 43

CUE MIX indicator 20
CUE MIX TO STEREO switch 15, 43
CUE PAN/CUE LEVEL controls 14
Cue/Review 66
CURSOR shuttle 18

D

DAT 108
DATA dial (DATA+ -) 18
DATA dial and CURSOR shuttle 61
direct recording 26
disc 10
disc contents 86
Disc Erase 86
Disc transport buttons 16
Display 19
display brightness 88
DISPLAY button 18
Display Messages 103

E

EDIT button 18
Editing functions 73
EJECT button 17
end marker 63
ENTER button 18
EQ 108
EQ controls 14
EXIT button 18
extend the length of Song 12, 79, 81, 86

F

Fader 14
Find a blank area 27
FIX (fixed) 84
FLIP switch 13
Foot switch 54, 89, 108
Frame 88, 108
Function buttons 18

G

GAIN control 13

I

IN, OUT indicators 21
Input channel 108
INSERT I/O jacks 22, 44
Inserting a marker 62

L

LAST REC SEARCH [IN] button 62
LAST REC SEARCH [IN]/[OUT] button 17
LAST REC SEARCH [OUT] button 62
last record in point 55, 62
last record out point 55, 62
Level (5/6), (7/8) controls 15
LINE INPUT 5~8 jacks 22
Locate 108

M

Manual punch-in/out 52, 53, 54
MARK button 17, 62
MARK SEARCH [◀]/[▶] button 17, 62
Marker indicators 21, 63
Markers 62
MD DATA 10, 108
MIC/LINE INPUT 1,2 jacks 22
MIC/LINE INPUT 3, 4 jacks 22
MIDI 109
Implementation chart 112
MIDI Clock 91, 92, 109
MIDI functions 90
MIDI IN connector 24
MIDI IN, OUT, THRU connectors 24
MIDI indicators 20
MIDI OUT connector 24
MIDI Song Position Pointer 91, 109
MIDI THRU connector 24
MIDI Timecode (MTC) 109
MiniDisc 10, 109
Mixdown 32, 109
Mixing multiple channels as you record 36
MMC (MIDI Machine Control) 98
MMC Device ID 99
MMC Master 98

MMC Slave 98
 monaural (MONO) 11
 Monitor CUE 109
 MONITOR LEVEL control 15
 MONITOR OUT jacks 23
 MONITOR SELECT switches 15
 Monitor/Master section 15
 Mono Inputs 13
 MTC 91, 94
 MTC Master 94
 MTC Slave 94
 Multi-take 58

O

One Song Repeat 67
 Overdub Recording 109
 Overdubbing 30

P

PAN control 14
 Part Copy 73
 Part Erase 74
 PAUSE button 16
 PB 109
 PEAK HOLD button 18
 Phone Jack 109
 PHONES jack 24
 Phono Jack 109
 Ping-Pong 109
 Ping-pong recording 39
 PITCH button 18
 Pitch function 84
 Pitch indicator 19
 PLAY button 16
 play forward (cue) 66
 PLAY indicator 16
 post-fader 14, 109
 post-roll point 55
 Post-Roll Time 109
 POWER switch 23
 pre-roll point 55
 Pre-Roll Time 109
 pre-roll/post-roll times 55
 Program Play 71
 PUNCH I/O jack 24, 89
 Punch-in/out 52, 53, 54, 109

Q

Quick search functions 61

R

Random Access 109
 REC button 16
 REC indicator 16
 REC SELECT buttons 17
 recording mode 11, 76, 87
 Recording the first track 26
 REHE button 16
 REHE indicator 16
 rehearsal function 52
 Rehearsing 57, 58
 REPEAT button 17, 67
 Repeat function 67
 Repeat indicator 21

S

SCMS 110
 SET button 17
 Signal to Noise Ratio 110
 Single-take 56
 Song Combine 80
 Song Copy 76
 Song Divide 79
 Song Erase 78
 Song Move 81
 Song Renumber 82
 SONG SEARCH [◀◀]/[▶▶] buttons 17, 61
 songs 12
 ST bus 108
 start marker 63
 Status indicators 19
 STEREO fader 15
 Stereo Inputs 15
 Stereo level meter 20
 STEREO OUT jacks 23
 STOP button 11
 STOP/TOC WRITE button 17

T

Tempo Map 92, 110
 Time counter 21
 Time counter mode 20
 Title and function display 19
 Titling 85
 TOC 11, 110
 TOC EDIT indicator 11, 19
 TOC WRITE button 11
 Track Copy 75
 TRACK DIRECT OUT 1~4 jacks 23

Track Erase 76
 Track level meters 20
 Track recording indicators 20
 Tracking 110

U

Unity gain 14, 110
 UTILITY button 18

V

VARI (variable) 84

X

x1/2 Play 67

Cue List		
Step	Section	Repeat
A	→	
B	→	
C	→	
D	→	
E	→	
F	→	
G	→	
H	→	
I	→	
J	→	
K	→	
L	→	
M	→	
N	→	
O	→	
P	→	
Q	→	
R	→	
S	→	
T	→	
U	→	
V	→	
W	→	
X	→	
Y	→	
Z	→	

Track List			
1	2	3	4

Session Info	
Title:	
Date:	
Step:	
Process:	
Notes:	

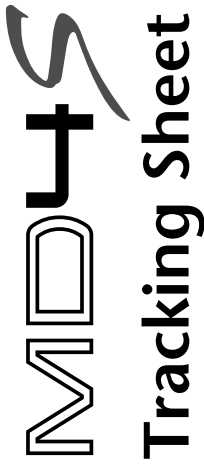

Mixer Setup			
Source:	Source:	Source:	Source:
1	2	3	4
5/6	7/8	CUE MIX TO STEREO <input type="checkbox"/> MONITOR SELECT 2TR IN <input type="checkbox"/> STEREO <input type="checkbox"/> CUE <input type="checkbox"/> MONITOR LEVEL <input type="checkbox"/> MIN MAX	

Marker Log	
	8
	7
	6
	5
	4
	3
	2
	1
	S
	10
	9
	E